



idol
surgical instruments

General



We shape steel for health



HAKKIMIZDA

2005 yılındaki kuruluşundan bu yana sağlık sektörünün gelişen ve değişen ihtiyaçlarını yakından izleyen İdol, cerrahi enstrümanlar alanında güvenilir bir çözüm ortağı olarak faaliyet göstermektedir. Tüm cerrahi branşlara yönelik enstrümanlar üreten İdol, klinik gereksinimleri doğru analiz ederek kullanıcı odaklı ve etkin çözümler sunar.

Faaliyetlerini EN ISO 13485 kalite yönetim sistemi doğrultusunda ve Avrupa Tıbbi Cihaz Regülasyonu 2017/745 (MDR) gerekliliklerine uygun olarak sürdüren İdol, 2023 yılında MDR uyumlu CE sertifikasını almaya hak kazanmıştır. Titiz kalite anlayışını teknik uzmanlıkla birleştiren İdol, cerrahi uygulamalarda güven veren, yüksek standartlara sahip ürünler geliştirmeye kararlılıkla devam etmektedir.

ABOUT US

Since its establishment in 2005, İdol has closely followed the evolving needs of the healthcare sector and has operated as a reliable solution partner in the field of surgical instruments. Producing instruments for all surgical branches, İdol accurately analyzes clinical requirements and offers user-focused and effective solutions.

Carrying out its activities in line with the EN ISO 13485 quality management system and in compliance with the requirements of the European Medical Device Regulation 2017/745 (MDR), İdol obtained its MDR-compliant CE certification in 2023. Combining meticulous quality principles with technical expertise, İdol continues to develop high-standard products that inspire confidence in surgical practice.



Catalog Explanations



refers to products that can be used integrated

delicate

identifies delicate and slim structured instruments



indicates the number of teeth on the end of instruments such as forceps and clamps

Atraumatic

defines that the jaw/tip structure of the instruments is trauma-free

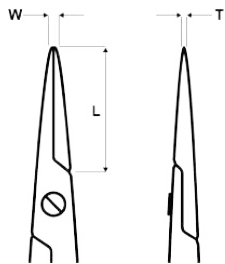

The dimensions of the micro needle holders are indicated as follows:

Length x Thickness x Width = L x T x W



indicates what size of suture material the needle holder is recommended for



Smooth insert (recommended for suture material 12-0 and smaller)



0,3 mm pitch of serration insert (recommended for suture material 9-0 and smaller)



0,4 mm pitch of serration insert (recommended for suture material 6-0 and smaller)



0,5 mm pitch of serration insert (recommended for suture material 4-0 and smaller)



defines that the jaws of instruments such as forceps and clamps have 1x2 DeBaKey features



defines that the jaws of instruments such as forceps and clamps have 2x3 DeBaKey features



defines that the jaws of instruments such as forceps and clamps have "V" shaped Baby DeBaKey features



defines that the jaws of instruments such as forceps and clamps have Cooley type features



indicates the size of the cutting edge of the scissors with the number written near



defines that the working ends/jaws of the instrument is tungsten carbide particle sprayed



defines that the working ends/jaws of the instrument is tungsten carbide insert

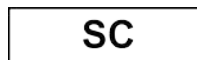

defines that the ends of the scissors is serrated edge/knife edge



defines that the ends of the scissors is tungsten carbide and serrated edge/knife edge



defines that the ends of the scissors is tungsten carbide and serrated edge/knife edge, black coated

25
24
23
22
21
20
19
18
17
16
15
14
13
12
11
10
9
8
7
6
5
4
3
2
1
cm

The blade dimensions of the retractors are specified as follows:

a X b : depth X width

Depth is written as the first number and width as the second number

Example: 14 X 25 mm

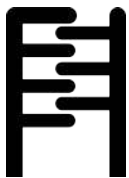
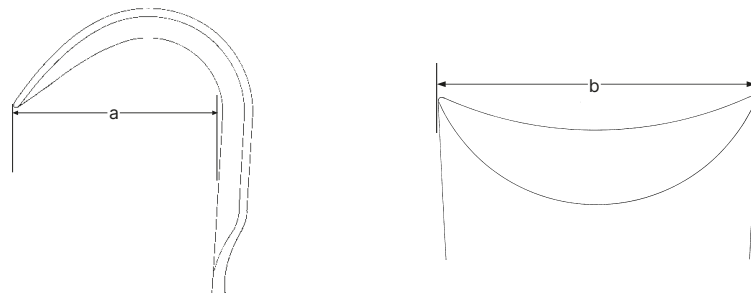
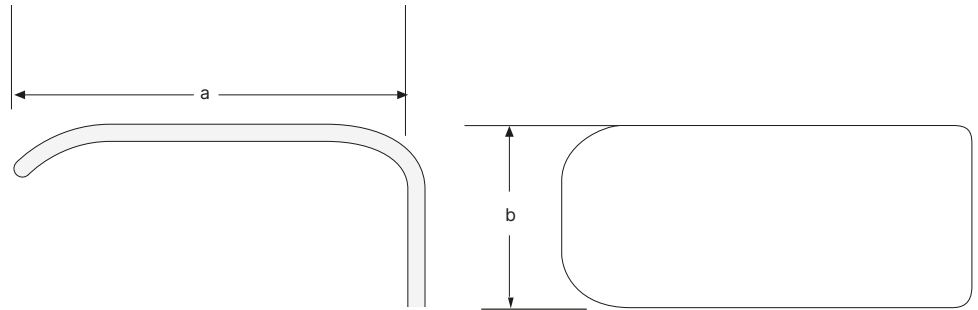

Specifies the number of prongs on the blades of spreaders

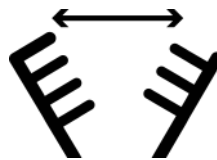

Indicates the opening width between the spreader blades

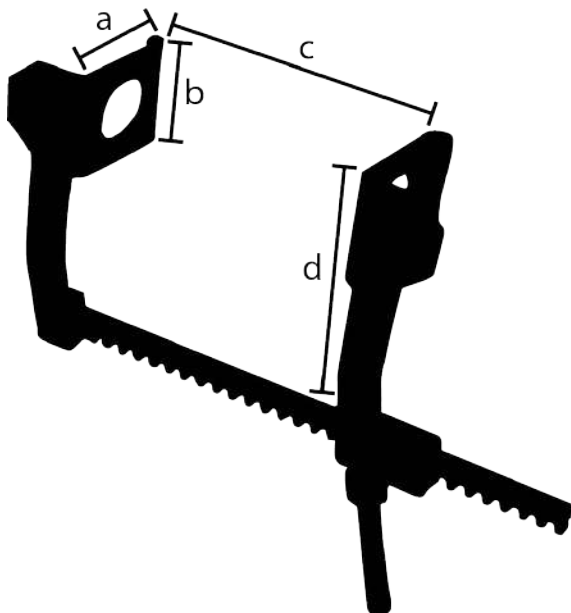

The dimensions of the retractors are specified as follows:

- a = Blade depth
- b = Blade width
- c = Spreading width
- d = Arm length

9
8
7
6
5
4
3
2
1
in



○ Scalpel Handles 1-5

○ Scissors 7-40

○ Forceps 41-61

○ Sponge and Dressing Clamps 63-67

○ Clamps 69-105

○ Needle Holders and Suture Instruments 107-126

○ Probes and Applicators 127-130

○ Spreading Instruments 131-211

○ Abdominal, Intestinal and Rectal Instruments 213-227

| | | |
|--|---|---------|
|  | Urology Instruments | 229-236 |
|  | Gynecology and Obstetric Instruments | 237-268 |
|  | Bone and Traumatology Instruments | 269-334 |
|  | Suction Tubes | 335-343 |
|  | Otology and Micro Ear Surgery Instruments | 345-364 |
|  | Rhinology, Rinoplasty, Sinus and Hypophysectomy Instruments | 365-392 |
|  | Tonsillectomy, Adenotomy, Laryngology and Tracheotomy Instruments | 393-409 |
|  | Examination-Diagnostic, Preparation, Anesthesia and Miscellaneous Instruments | 411-417 |

Scalpel Handles

Scalpel Handles for Blades Fig.10-17
Scalpel Handles for Blades Fig.18-36
Scalpel Handles for Micro Scalpel Blades





Scalpel Handles

Scalpel Handles for Blades Fig.10-17 and Fig.18-36



BS 201-03
12 cm / 4⁶/₈"



BS 201-04
13,5 cm / 5³/₈"



BS 200-03
12 cm / 4⁶/₈"



BS 202-13
21,5 cm / 8⁴/₈"



BS 220-21
20,5 cm / 8¹/₈"



BS 203-14
21 cm / 8²/₈"



BS 221-21
20,5 cm / 8¹/₈"



1/1 No. 7

BS 210-07
16 cm / 6 2/8"



1/1 No.7K

BS 211-07
12,5 cm / 4 7/8"



1/1 No. 3

BS 212-16
14 cm / 5 4/8"



1/1 No. 3

BS 213-16
14 cm / 5 4/8"



Scalpel Handles

Scalpel Handles for Blades Fig.10-17



1/1

BS 231-21
22,5 cm / 8 7/8"



1/1

BS 232-21
22,5 cm / 8 7/8"



1/1

BS 241-21
21 cm / 8 2/8"



BS 242-01
13,5 cm / 5 1/4"



BS 242-02
15,5 cm / 6"



BS 242-03
18 cm / 7"



BS 242-04
20 cm / 8"



$\frac{1}{2}$
BS 243-21
21 cm / 8 2/5"



$\frac{1}{2}$
BS 244-25
25 cm / 10"

Scissors

Micro Scissors
Operating Scissors
Dissecting Scissors
Delicate Dissecting
Scissors Iris Scissors
Gum Scissors
Vascular Scissors
Gall Duct Scissors
Neurosurgery Scissors
Tonsil Scissors
Nasal Scissors
Gynecological Scissors
Uterine Scissors Episiotomy
Scissors Umbilical Scissors
Enterotomy Scissors
Bandage Scissors
Plaster Shears





Scissors
Micro Scissors

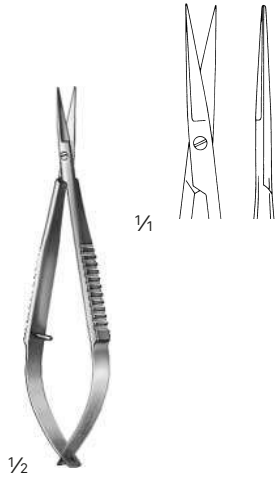

MA 910-02
10 cm / 3 7/8"

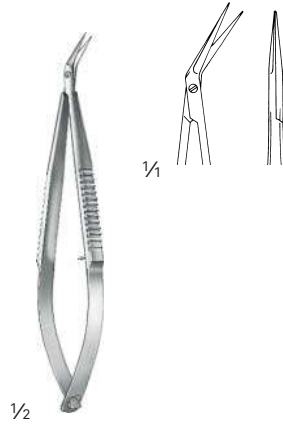

MA 912-09
9,5 cm / 3 6/8"



Westcott
11,5 cm / 4 4/8"

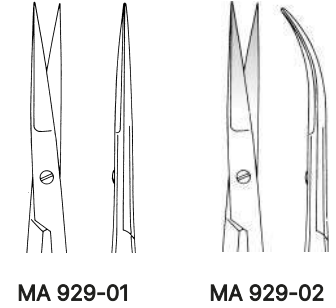

MA 929-01

MA 929-02



1/4



11 mm

12 cm / 4 6/8"

sharp/sharp

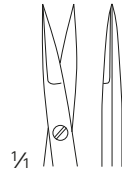

1/4

MA 900-12

sharp/sharp



MA 901-12

blunt/blunt



MA 902-12



1/2



9 mm

1/4

sharp/sharp



12 cm / 4 3/4"

MA 903-12

15 cm / 5 7/8"

MA 984-15

18 cm / 7 1/8"

MA 984-18

21 cm / 8"

MA 984-21

sharp/sharp



MA 904-12

MA 985-15

MA 985-18

MA 985-21

blunt/blunt



MA 906-12

MA 947-07

MA 947-08

sharp/sharp
one serrated



MA 947-01

MA 947-02

sharp/sharp
one serrated

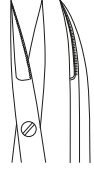

MA 947-04

MA 947-05



1/2



10 mm

blunt/blunt



1/4

15 cm / 5 7/8"

MA 986-15

18 cm / 7 1/8"

MA 986-18

21 cm / 8"

MA 986-21

23 cm / 9 1/16"

MA 986-23

sharp/sharp
one serrated



MA 987-15

MA 987-18

MA 987-21

MA 987-23

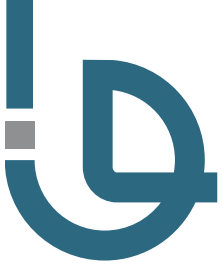









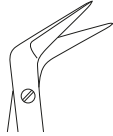
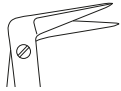

Scissors

Micro Scissors

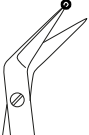

1/2

| | 25° | 45° | 60° | 90° | 125° |
|---|---|---|---|---|---|
|  |  |  |  |  |  |
| 18 cm / 7 1/8" | MA 975-01 | MA 975-02 | MA 975-03 | MA 975-04 | MA 975-05 |
| | 25° | 45° | 60° | 90° | 125° |
|  |  |  |  |  |  |
| 18 cm / 7 1/8" | MA 976-01 | MA 976-02 | MA 976-03 | MA 976-04 | MA 976-05 |

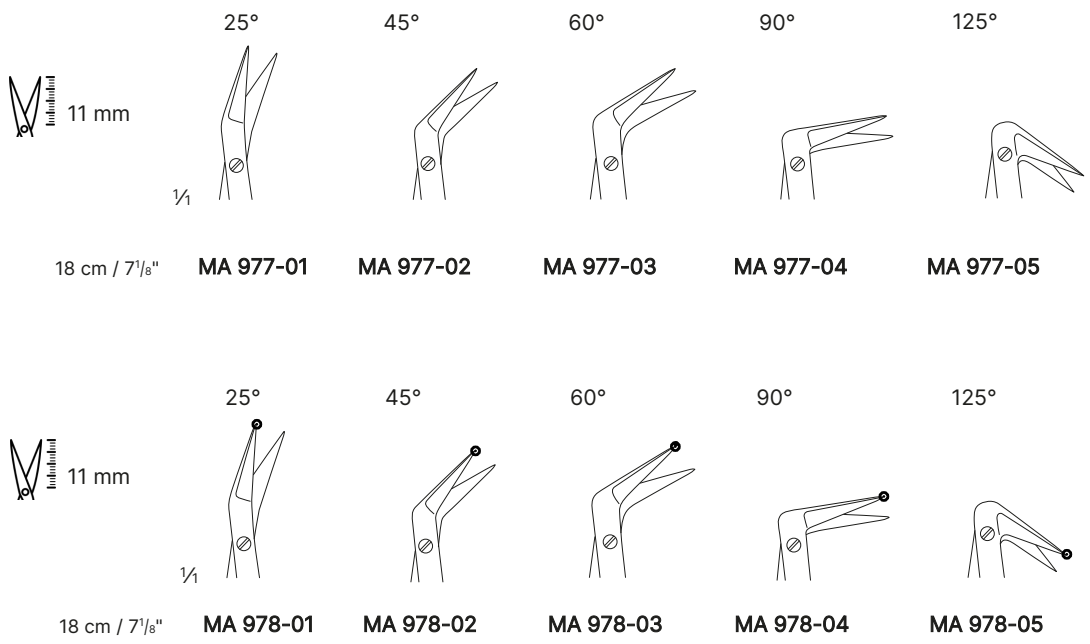

1/2



Scissors

Operating Scissors



1/2

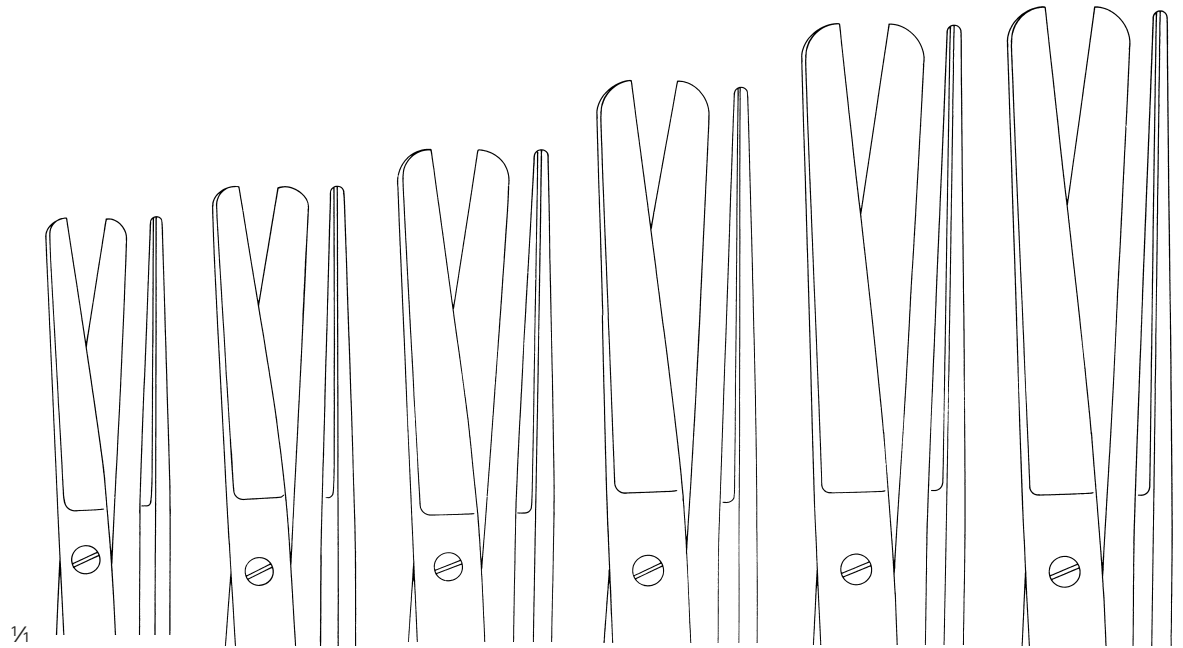

1/4

11,5 cm / 4 1/2"

13 cm / 5 1/8"

14,5 cm / 5 6/8"

16,5 cm / 6 4/8"

18,5 cm / 7 2/8"

20,5 cm / 8 1/8"

Regular

MA 100-11

MA 100-13

MA 100-14

MA 100-16

MA 100-18

MA 100-20



MA 850-14



1/2

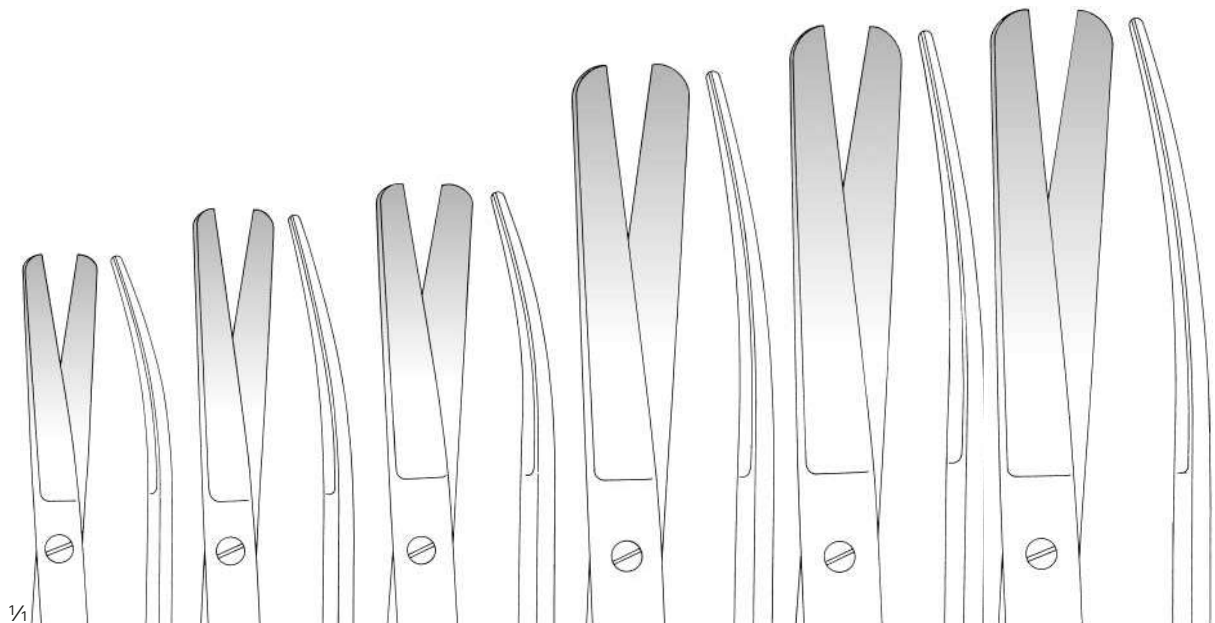

1/4

11,5 cm / 4 1/2"

13 cm / 5 1/8"

14,5 cm / 5 6/8"

16,4 cm / 6 4/8"

18,5 cm / 7 2/8"

20,5 cm / 8 1/8"

Regular

MA 101-11

MA 101-13

MA 101-14

MA 101-16

MA 101-18

MA 101-20



MA 851-14



1/2

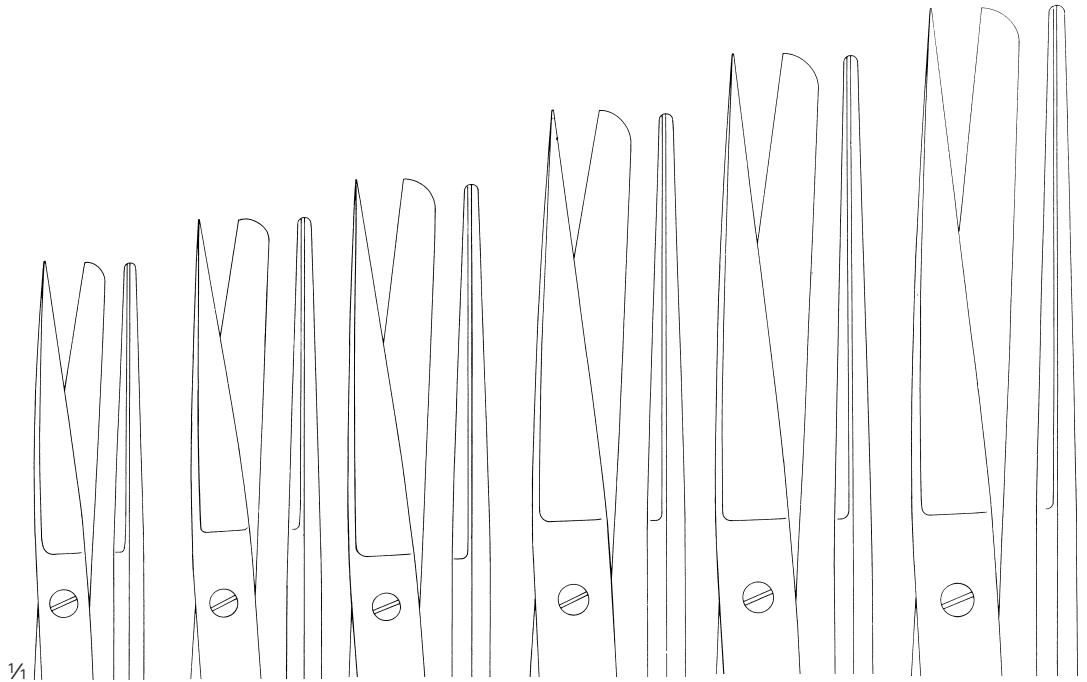

1/4

11,5 cm / 4 1/2"

13 cm / 5 1/8"

14,5 cm / 5 9/16"

16,5 cm / 6 4/8"

18,5 cm / 7 2/8"

20,5 cm / 8 1/8"

Regular

MA 102-11

MA 102-13

MA 102-14

MA 102-16

MA 102-18

MA 102-20



MA 852-14



1/2

1/4

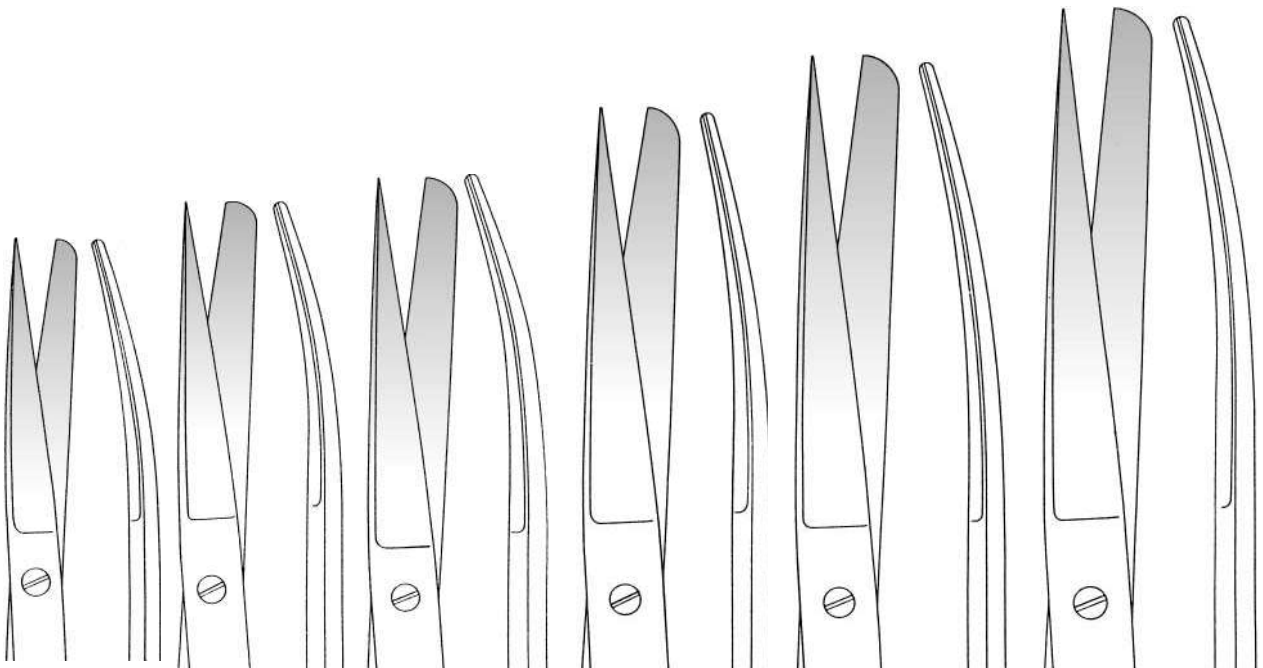

11,5 cm / 4 1/2"

13 cm / 5 1/8"

14,5 cm / 5 9/16"

16,5 cm / 6 4/8"

18,5 cm / 7 2/8"

20,5 cm / 8 1/8"

Regular

MA 103-11

MA 103-13

MA 103-14

MA 103-16

MA 103-18

MA 103-20



MA 853-14

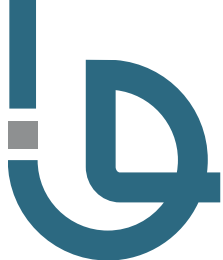

Scissors

Operating Scissors



1/2

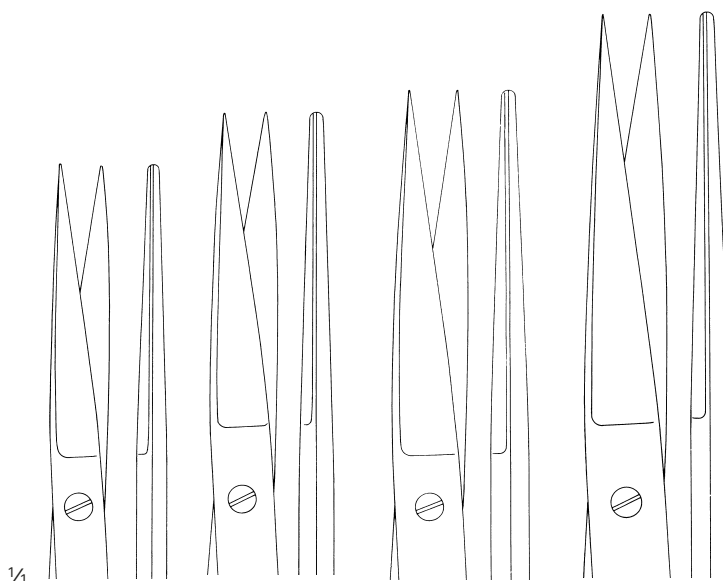

1/4

11,5 cm / 4 1/2"

13 cm / 5 1/8"

14,5 cm / 5 9/16"

16,5 cm / 6 4/8"

Regular

MA 104-11

MA 104-13

MA 104-14

MA 104-16



MA 854-14



1/2

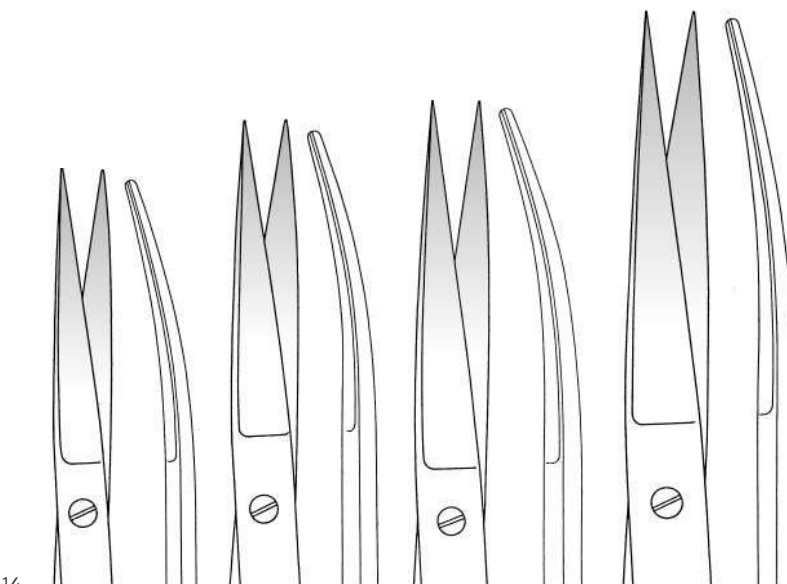

1/4

11,5 cm / 4 1/2"

13 cm / 5 1/8"

14,5 cm / 5 9/16"

16,5 cm / 6 4/8"

Regular

MA 105-11

MA 105-13

MA 105-14

MA 105-16



MA 855-14

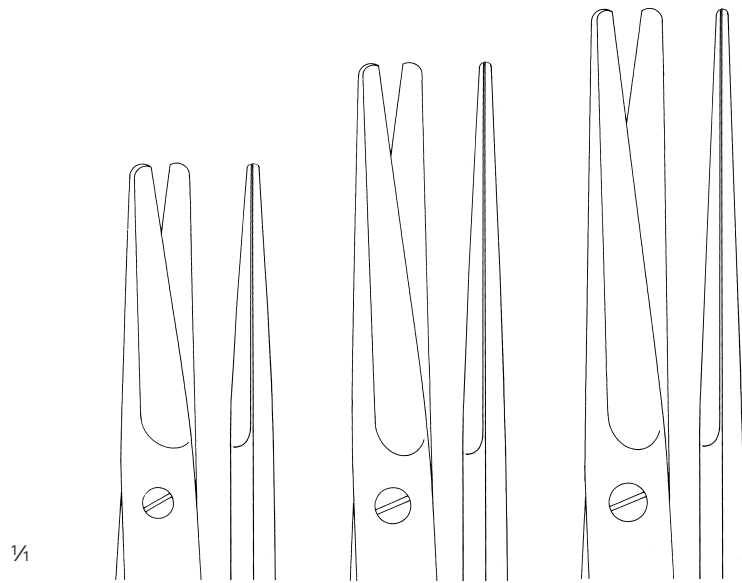

Regular
TC

14,5 cm / 5 6/8"

MA 125-14

MA 856-14

17 cm / 6 6/8"

MA 125-17

MA 856-17

23 cm / 9"

MA 125-23

MA 856-23

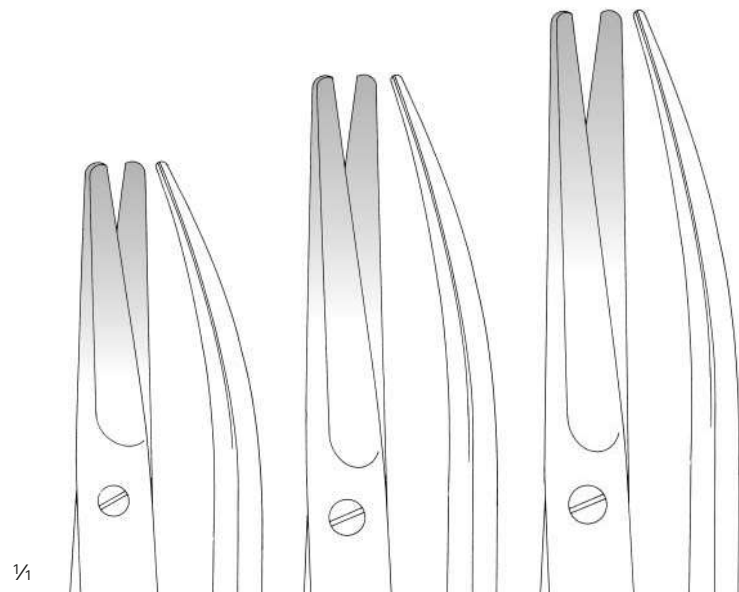

Regular
TC

14,5 cm / 5 6/8"

MA 126-14

MA 857-14

17 cm / 6 6/8"

MA 126-17

MA 857-17

23 cm / 9"

MA 126-23

MA 857-23



Scissors

Dissecting Scissors



1/2

Mayo
MA 126-28
28 cm / 11"



1/4



1/2

Mayo-Noble
17 cm / 6 7/8"

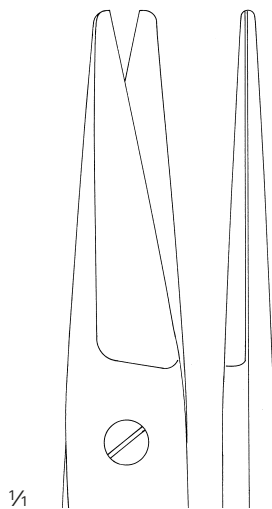

1/4

MA 120-17

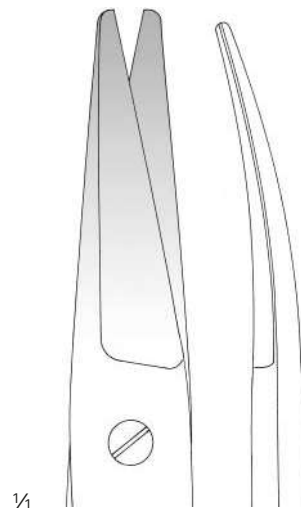

1/4

MA 121-17



Mayo-Stillie

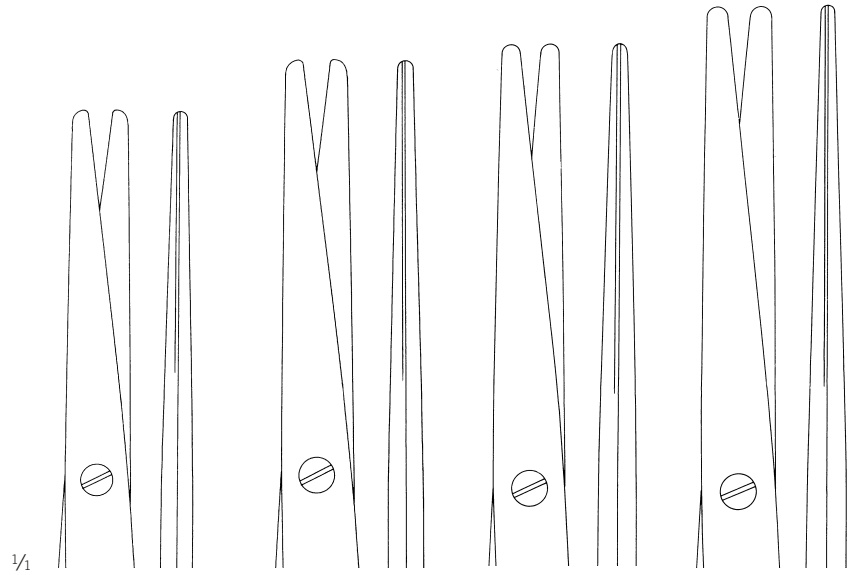

15 cm / 5 ⁷/₈"

17 cm / 6 ⁶/₈"

19,5 cm / 7 ⁵/₈"

21 cm / 8 ²/₈"

Regular

MA 127-15

MA 127-17

MA 127-19

MA 127-21



MA 859-15

MA 859-17



Mayo-Stillie

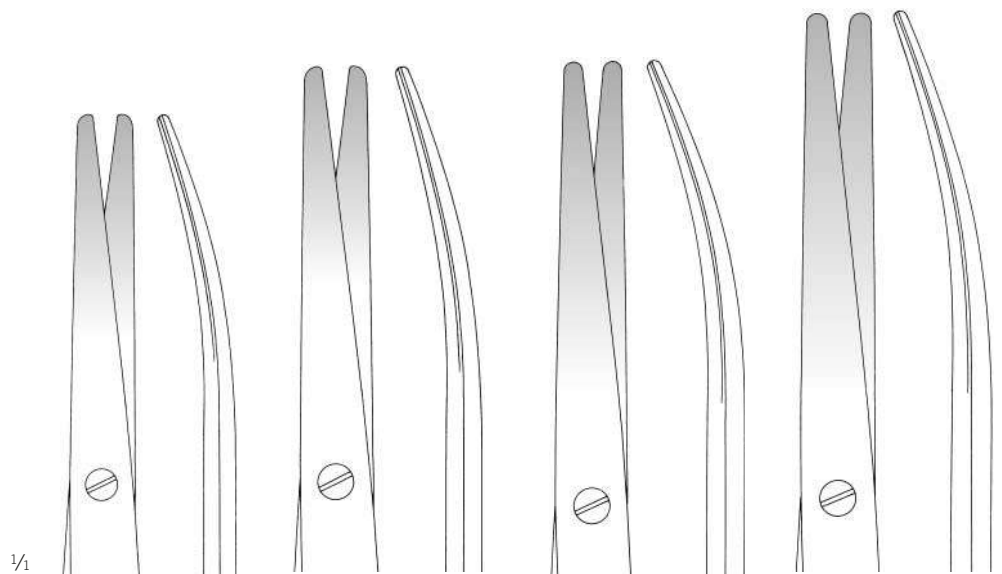

15 cm / 5 ⁷/₈"

17 cm / 6 ⁶/₈"

19,5 cm / 7 ⁵/₈"

21,5 cm / 8 ⁴/₈"

Regular

MA 128-15

MA 128-17

MA 128-19

MA 128-21



MA 860-15

MA 860-17

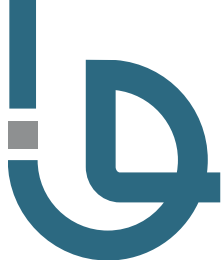

Scissors

Dissecting Scissors



1/2

Lexer

16 cm / 6 2/8"

Regular

TC

1/4

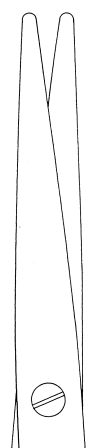

MA 220-16

MA 873-16

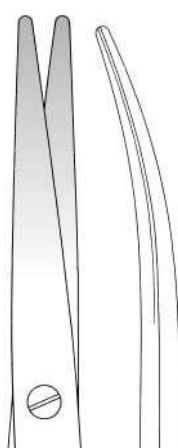

MA 221-16

MA 874-16



1/2

Lexer-Baby

10 cm / 3 7/8"

1/4

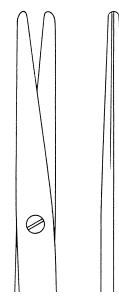

MA 224-10

1/4

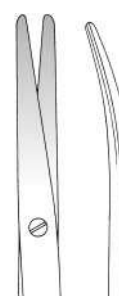

MA 225-10



1/2

Metzenbaum

Regular

TC

SC

TC/SC

1/4

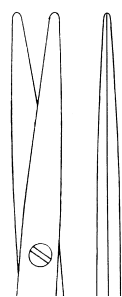

11,5 cm / 4 1/2"

MA 155-11

MA 865-11

MA 891-11

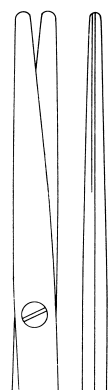

14,5 cm / 5 9/16"

MA 149-14

MA 867-14

MA 891-14



11,5 cm / 4 1/2"

MA 156-11

MA 866-11

MA 892-11

MA 896-11

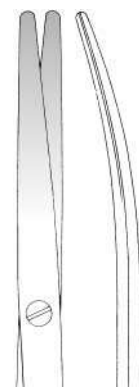

14,5 cm / 5 9/16"

MA 150-14

MA 868-14

MA 892-14

MA 896-14

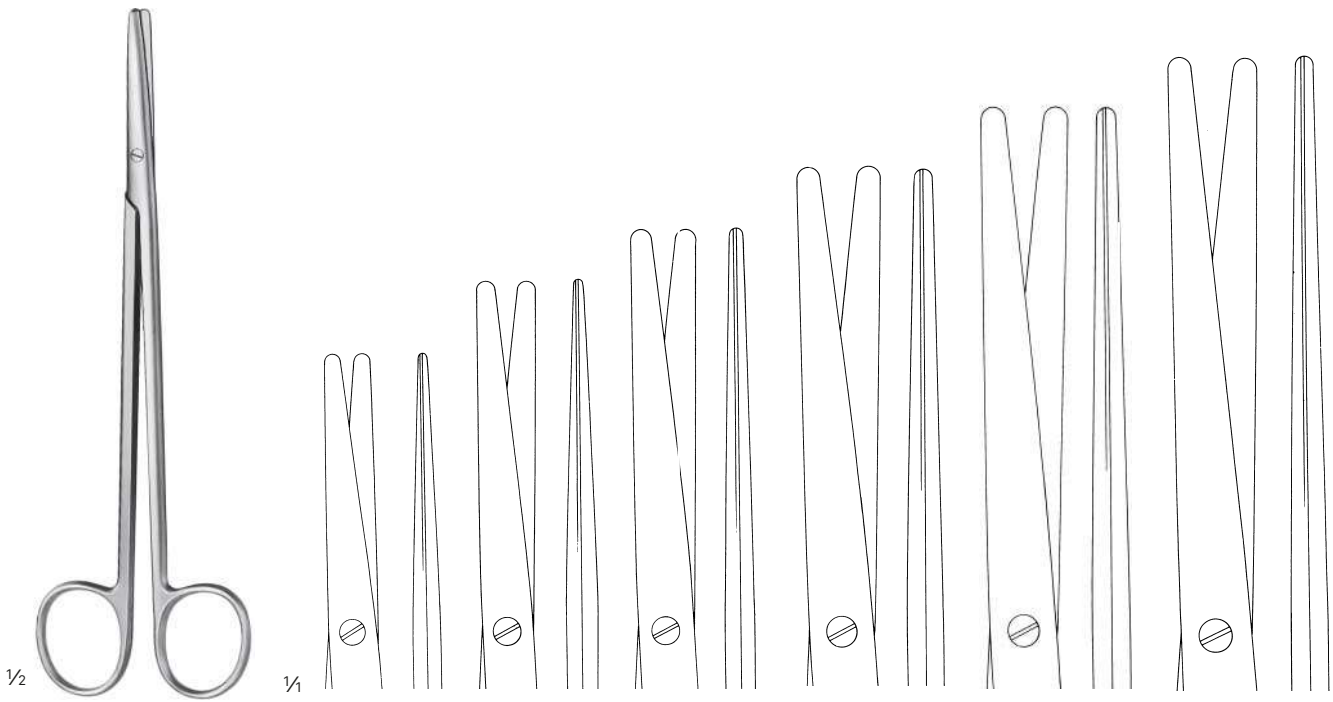

Metzenbaum

| | | | | | | |
|----------------|-----------|-----------|-----------|-----------|-----------|-----------|
| Regular | MA 200-18 | MA 200-20 | MA 200-23 | MA 200-25 | MA 200-28 | MA 200-30 |
| TC | MA 869-18 | MA 869-20 | MA 869-23 | MA 869-25 | MA 869-28 | MA 869-30 |
| SC | MA 891-18 | MA 891-20 | MA 891-23 | MA 891-25 | MA 891-28 | |
| TC/SC | MA 893-18 | MA 893-20 | MA 893-23 | | | |

18 cm / 7 1/8"

20,5 cm / 8 1/8"

23 cm / 9"

26 cm / 10 2/8"

28,5 cm / 11 2/8"

31 cm / 12 2/8"

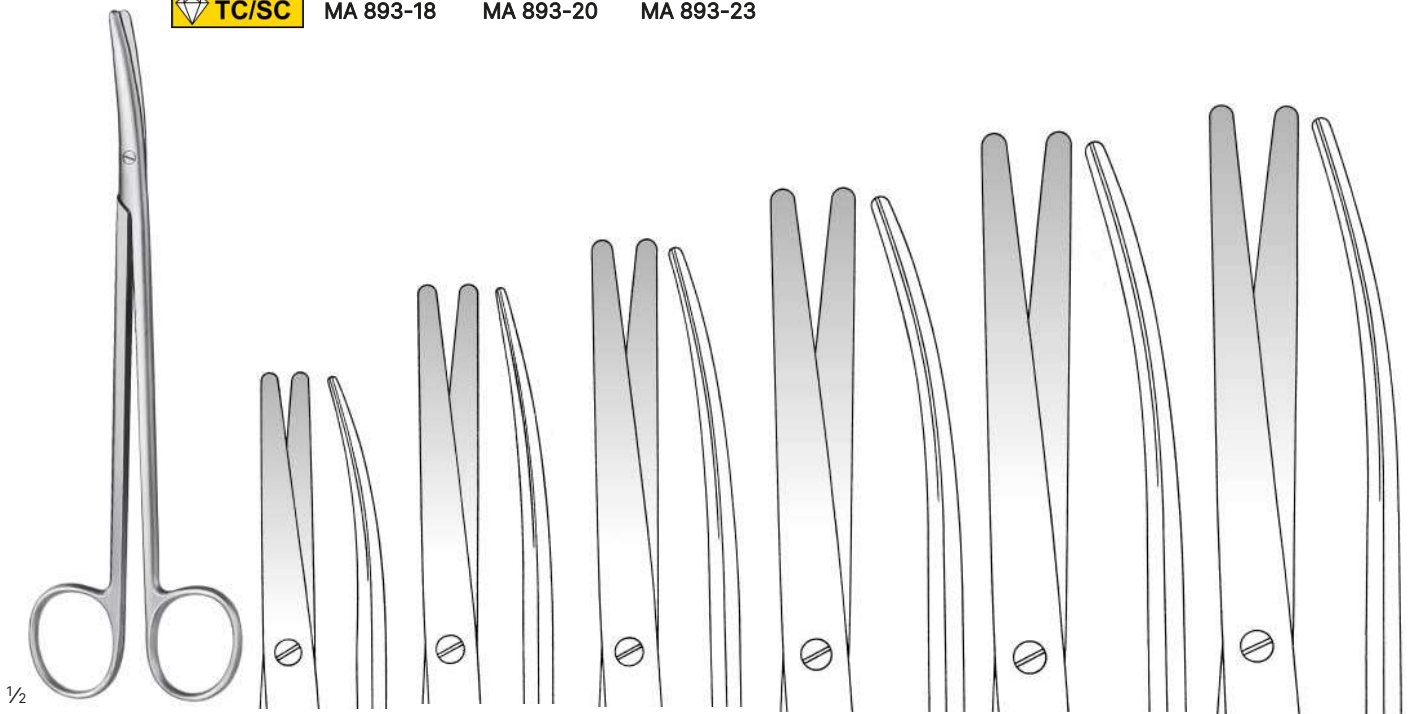

| | | | | | | |
|------------------|-----------|-----------|-----------|-----------|-----------|-----------|
| Regular | MA 201-18 | MA 201-20 | MA 201-23 | MA 201-25 | MA 201-28 | MA 201-30 |
| TC | MA 870-18 | MA 870-20 | MA 870-23 | MA 870-25 | MA 870-28 | MA 870-30 |
| SC | MA 892-18 | MA 892-20 | MA 892-23 | MA 892-25 | MA 892-28 | |
| TC/SC | MA 894-18 | MA 894-20 | MA 894-23 | MA 894-25 | | |
| BlackLine | MA 896-18 | MA 896-20 | MA 896-23 | MA 896-25 | | |

18 cm / 7 1/8"

20,5 cm / 8 1/8"

23 cm / 9"

26 cm / 10 2/8"

28,5 cm / 11 2/8"

31 cm / 12 1/8"



Scissors

Delicate Dissecting Scissors



1/2

Metzenbaum

delicate

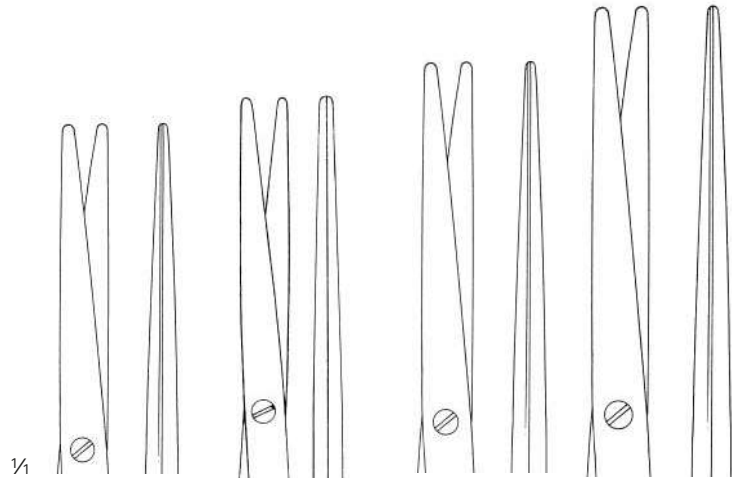

1/4

14,5 cm / 5 9/16"

18 cm / 7 1/8"

20,5 cm / 8 1/8"

23 cm / 9"

Regular

MA 210-14

MA 214-18

MA 214-20

MA 214-23

TC

MA 875-14

MA 879-18



1/2

Metzenbaum

delicate

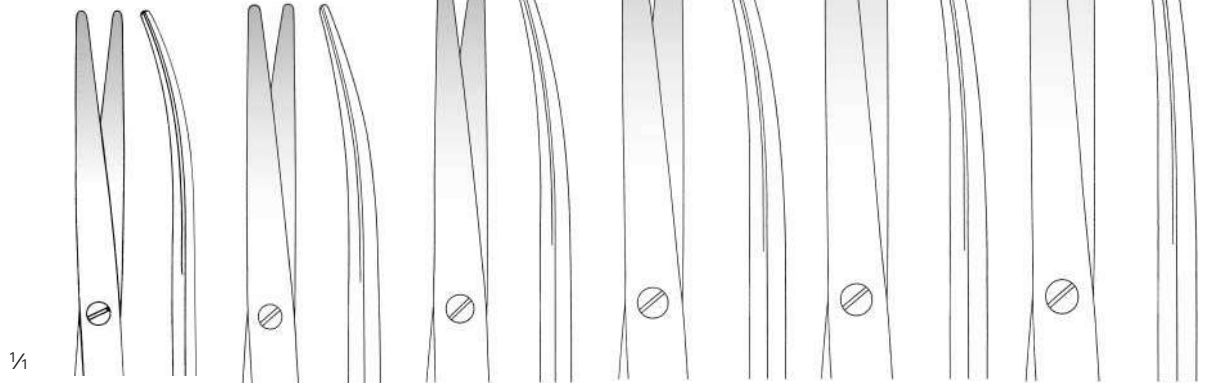

1/4

14,5 cm / 5 9/16"

18 cm / 7 1/8"

20,5 cm / 8 1/8"

23 cm / 9"

26 cm / 10 2/8"

28,5 cm / 11 2/8"

Regular

MA 211-14

MA 215-18

MA 215-20

MA 215-23

TC

MA 876-14

MA 880-18

MA 880-20

MA 880-23

MA 880-25

MA 880-28



delicate

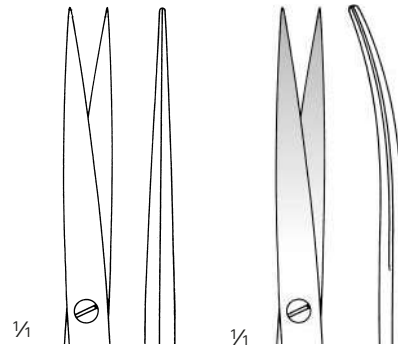

Regular



14,5 cm / 5 9/16"

MA 212-14

MA 877-14

14,5 cm / 5 9/16"

MA 213-14

MA 878-14



delicate



Regular



17,5 cm / 6 7/8"

MA 255-17

MA 883-17



Scissors

Delicate Dissecting Scissors

delicate



1/2

15,5 cm / 6 1/8"

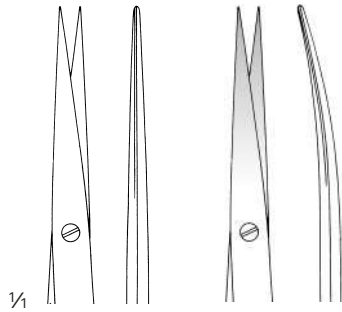

1/4

MA 218-15

MA 219-15

delicate



1/2

11,5 cm / 4 4/8"

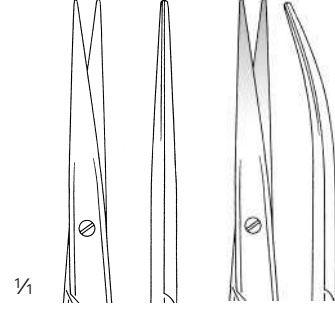

1/4

MA 565-11

MA 566-11

delicate



1/2

Reynolds

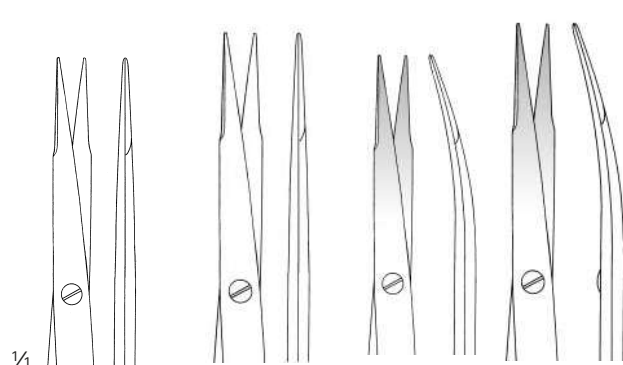

1/4

14 cm / 5 4/8"

MA 232-15

18 cm / 7 1/8"

MA 232-18

14 cm / 5 4/8"

MA 233-15

18 cm / 7 1/8"

MA 233-18

delicate



1/2

Jameson
MA 354-15

15,5 cm / 6 1/8"

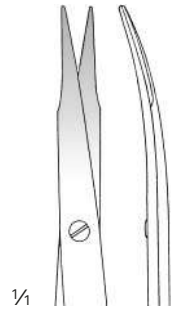

1/4

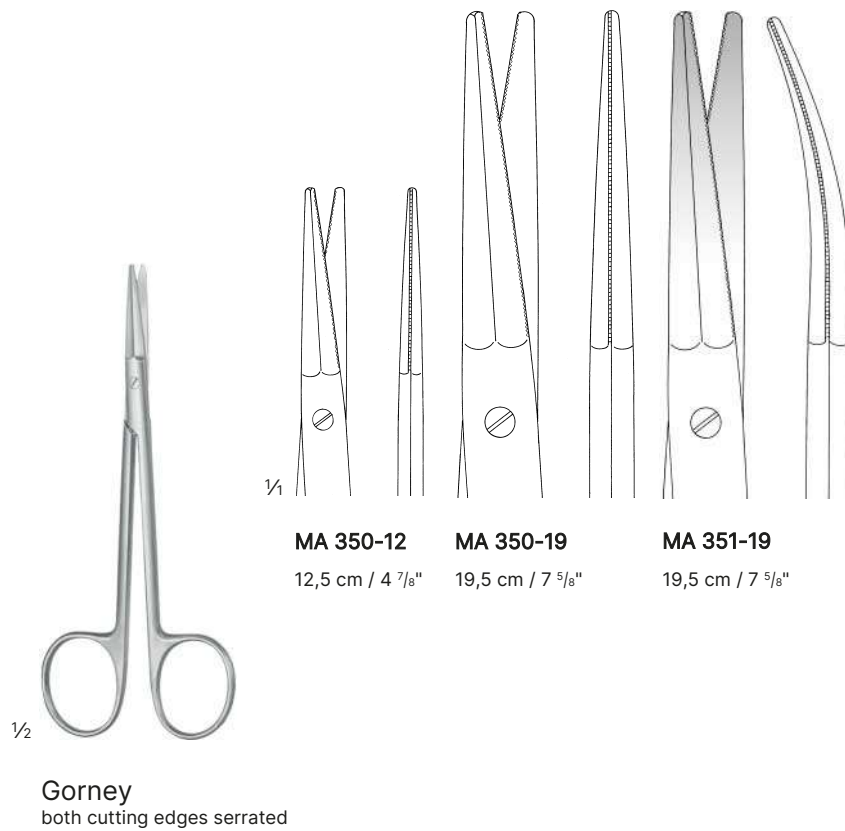
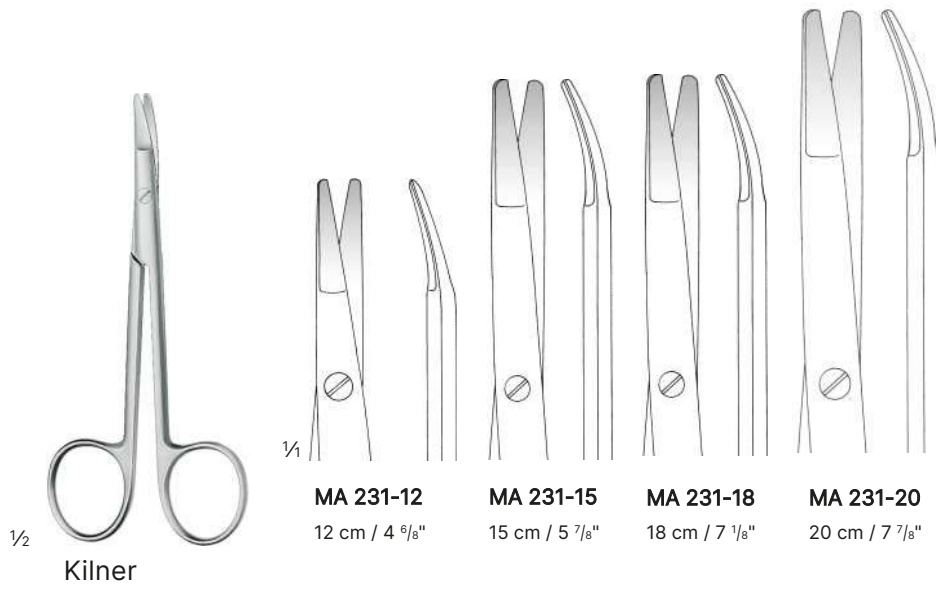



Scissors

Iris Scissors, Delicate Dissecting Scissors



1/2

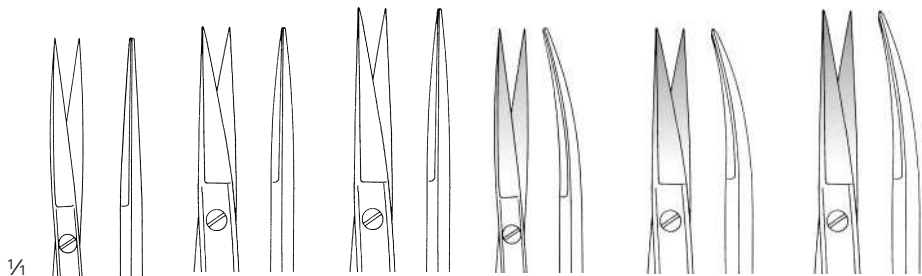

1/4

9 cm / 3 4/8"

10,5 cm / 4 1/8"

11,5 cm / 4 4/8"

9 cm / 3 4/8"

10,5 cm / 4 1/8"

11,5 cm / 4 4/8"

Regular

 **TC**

SC

 **TC/SC**

MA 561-09

MA 561-10

MA 561-11

MA 562-09

MA 562-10

MA 562-11

MA 886-11

MA 887-11

MA 893-11

MA 894-11

MA 897-11

MA 898-11



1/4

11 cm / 4 3/8"

MA 573-11

sharp/sharp

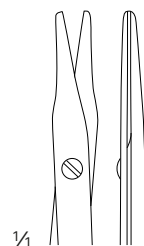

1/4

10,5 cm / 4 1/8"

MA 575-10

blunt/blunt



1/2

Stevens

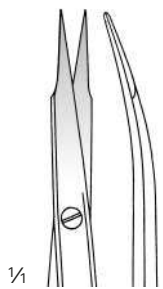

1/4

11 cm / 4 3/8"

MA 574-11

sharp/sharp



1/2

Stevens

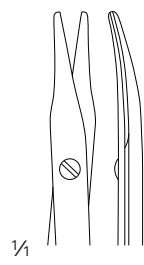

1/4

10,5 cm / 4 1/8"

MA 576-10

blunt/blunt



1/2

Kelly

16 cm / 6 2/8"

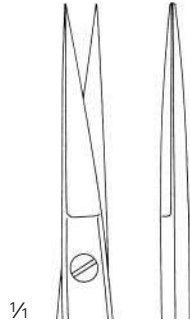

1/4

MA 134-16

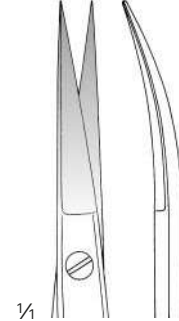

1/4

MA 135-16



1/2

Joseph

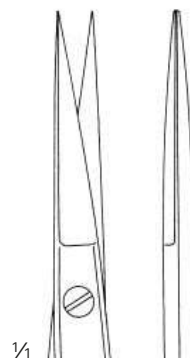

1/4

14,5 cm / 5 9/16"

Regular

MA 228-14



TC

MA 886-14



1/4

14,5 cm / 5 9/16"

MA 229-14

MA 887-14



Scissors

Operating Scissors, Gum Scissors

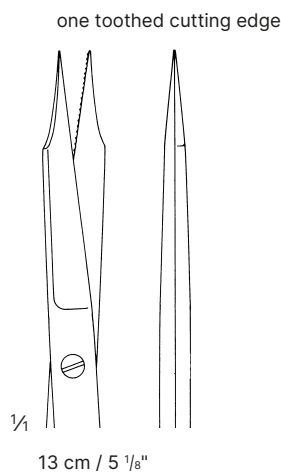
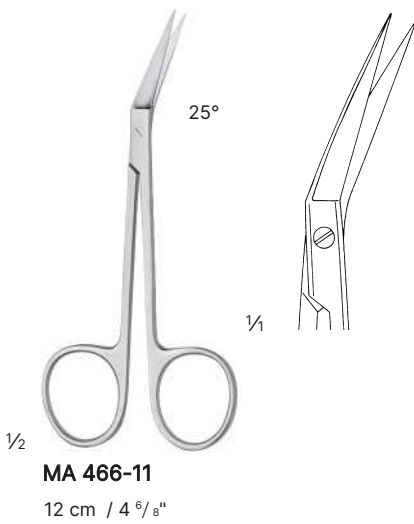
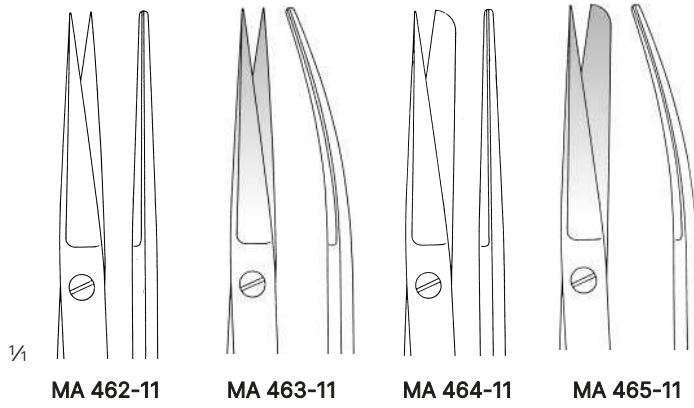

13 cm / 5 1/8"

MA 710-13

MA 884-13

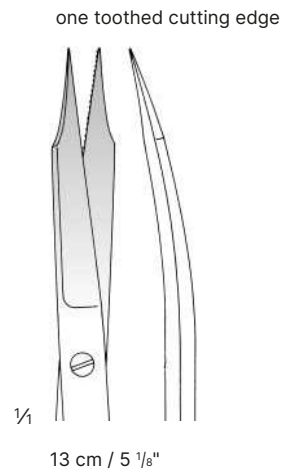

13 cm / 5 1/8"

MA 711-13

MA 885-13



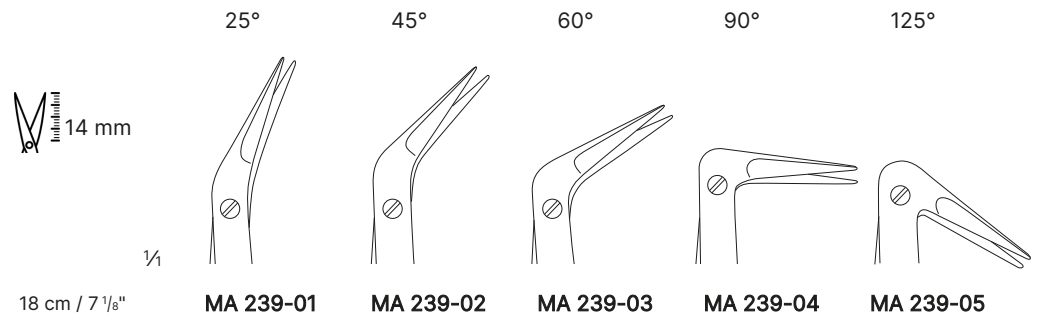
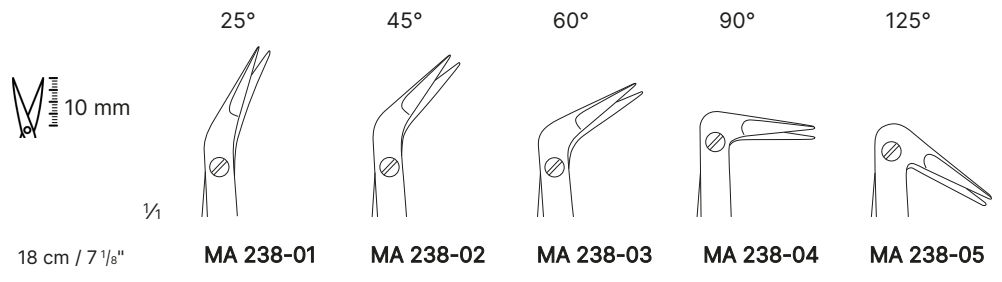
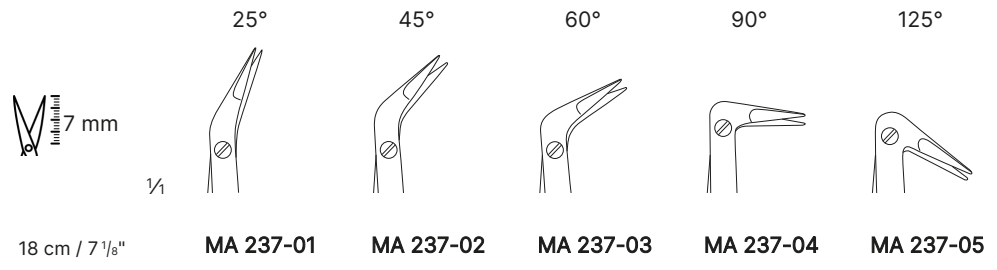

1/2

Dietrich-Potts



Scissors

Vascular Scissors



1/2

Potts-Smith



60°

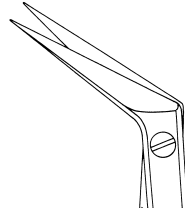

MA 234-60
18 cm / 7 1/8"

40°

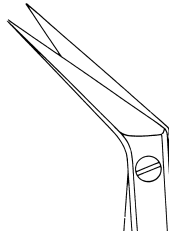

MA 234-45
18,5 cm / 7 2/8"

25°



MA 234-25
19 cm / 7 4/8"

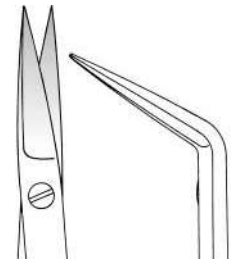

MA 241-19
19,5 cm / 7 5/8"



1/2

Diethrich
MA 240-19

17,5 cm / 6 7/8"



125°



1/4 with guidance



1/2

De Bakey

16 cm / 6 2/8"



45°

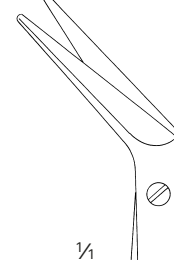

MA 235-16



60°

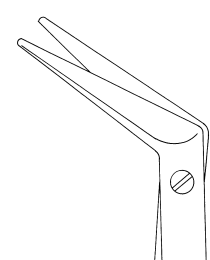

MA 236-16

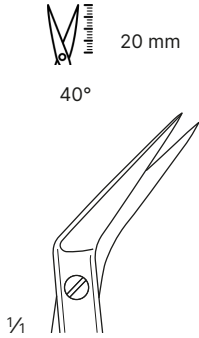

MA 871-45
18 cm / 7¹/₈"

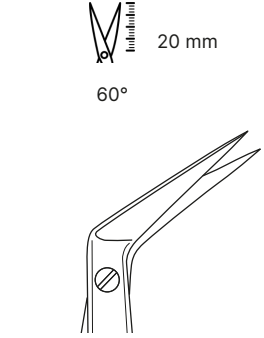

MA 871-60
18,5 cm / 7²/₈"

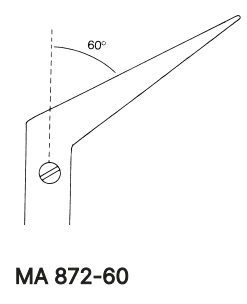
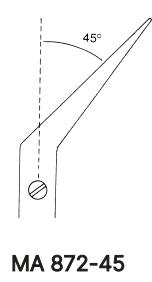
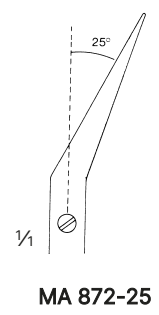



Scissors

Vascular Scissors, Neurosurgery Scissors



1/2

Strully

22 cm / 8 5/8"

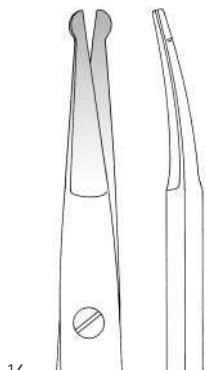

1/4

MA 245-22

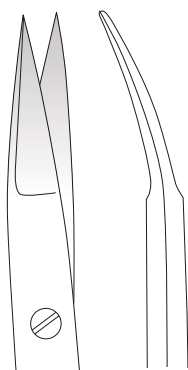

MA 246-22



1/2

Dandy

17 cm / 6 2/3"

MA 247-17

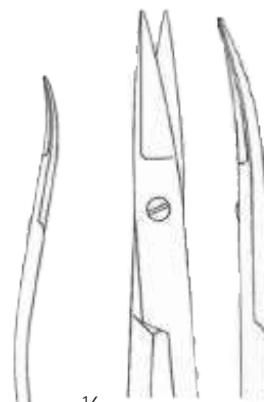

1/4



1/2

Thorek

MA 223-19

18,5 cm / 7 2/8"

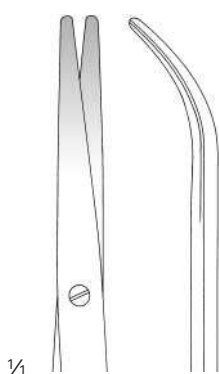

1/4

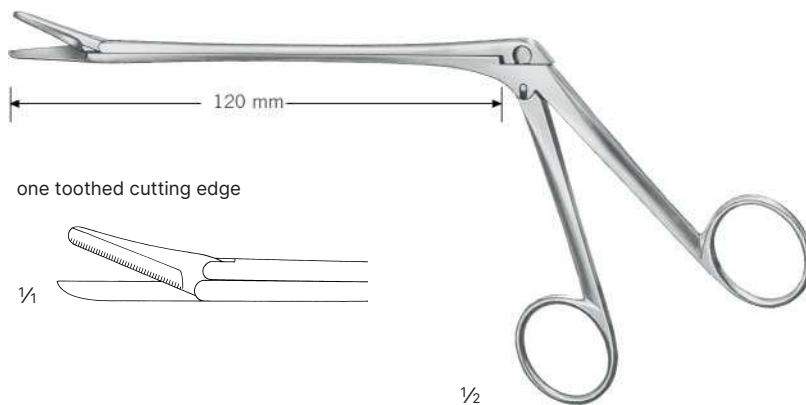

120 mm

one toothed cutting edge

1/4

1/2

Olivecrona

MA 309-23

23 cm / 9"

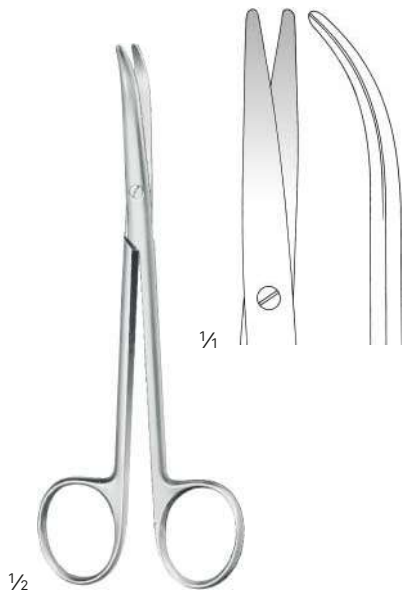

$\frac{1}{2}$
Fomon
MA 222-13
14 cm / 5⁴/₈"

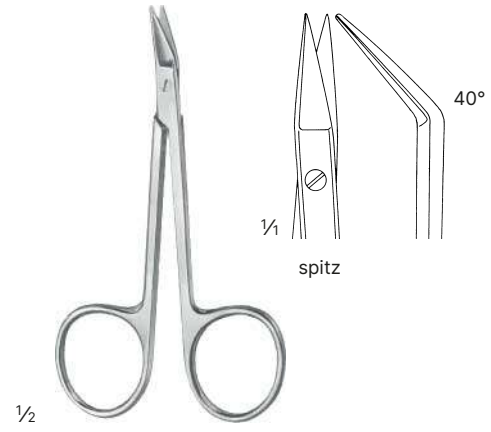

$\frac{1}{2}$
Converse
MA 570-10
10 cm / 3⁷/₈"

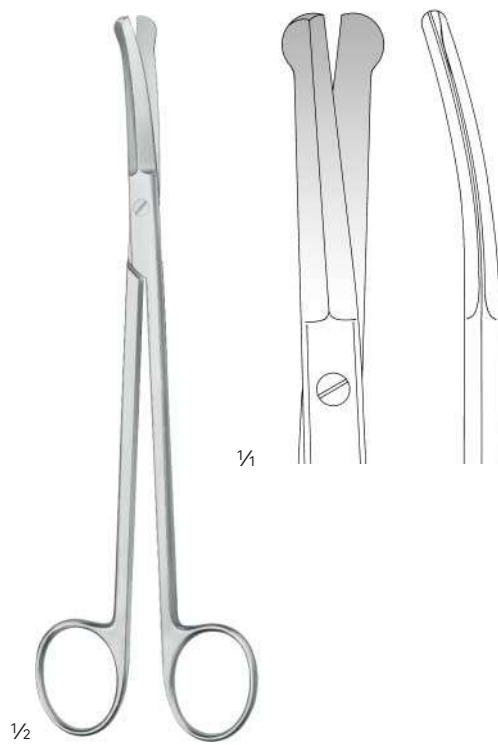

$\frac{1}{2}$
Good
KB 602-19
19,5 cm / 7⁵/₈"



Scissors

Gynecological Scissors



1/2

Wertheim

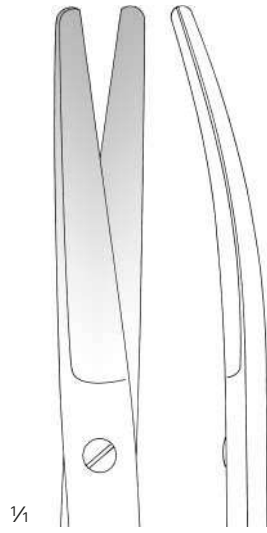

1/4

MA 136-19
20 cm / 7 7/8"

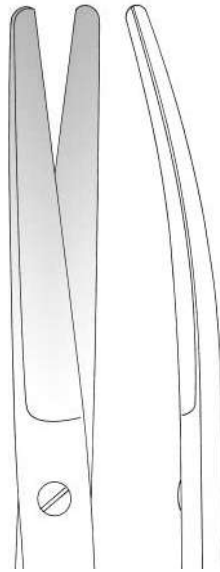

MA 136-23
23 cm / 9"

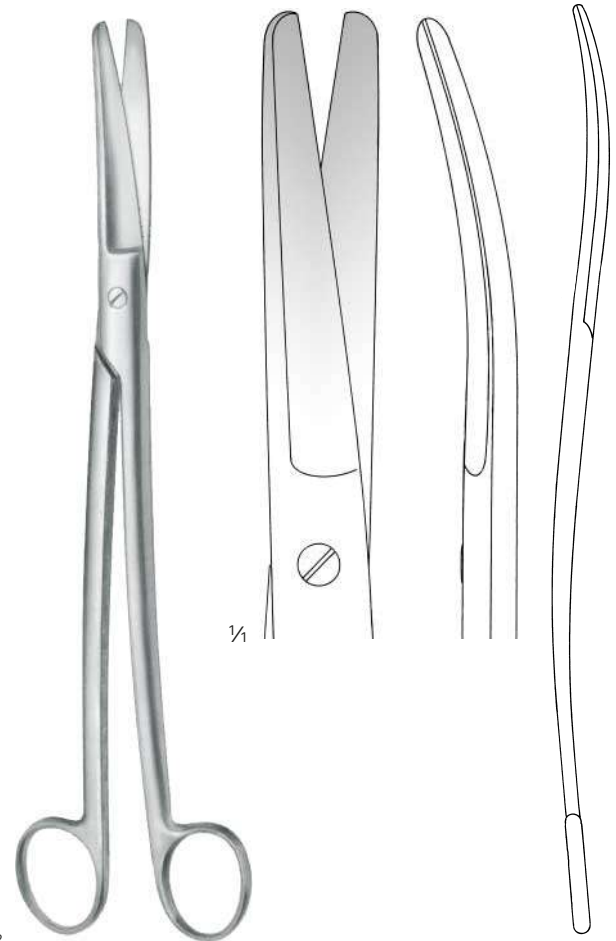

1/2

Sims-Siebold
MA 148-24
24,5 cm / 9 5/8"



1/2

Sims

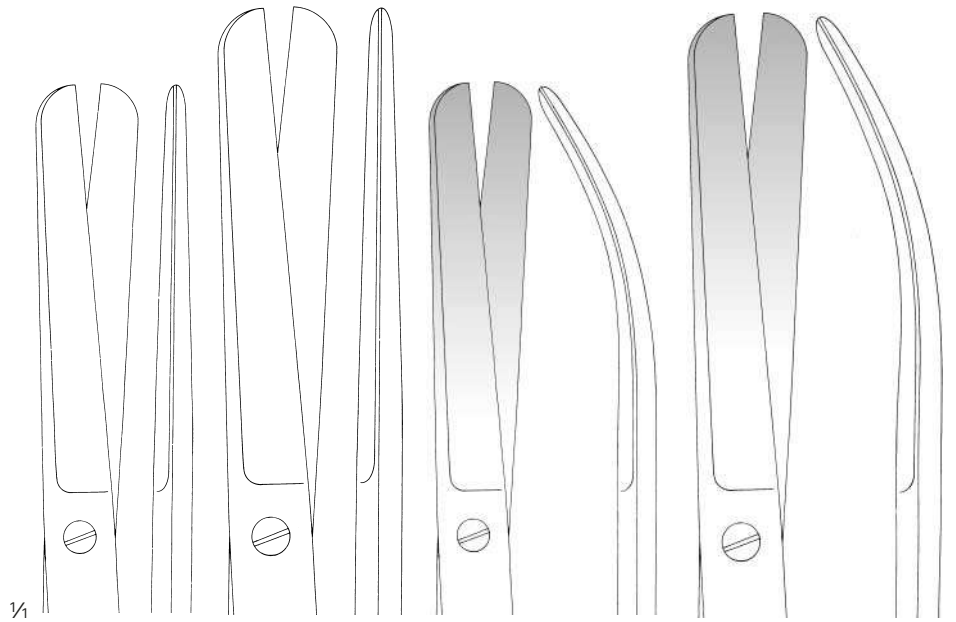

1/4

20 cm / 7 7/8"

23 cm / 9"

20 cm / 7 7/8"

23 cm / 9"

Regular

MA 140-20

MA 140-23

MA 143-20

MA 143-23

TC

MA 861-23

MA 862-23

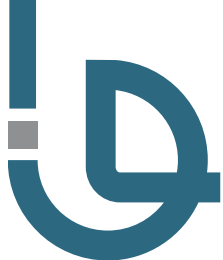

Scissors

Uterine Scissors



 TC

MA 858-01

22 cm / 8 ⁵/₈"

MA 858-02

23 cm / 9"



35°

1/4

1/2

Braun-Stadler
MA 453-14
14,5 cm / 5⁵/₈"

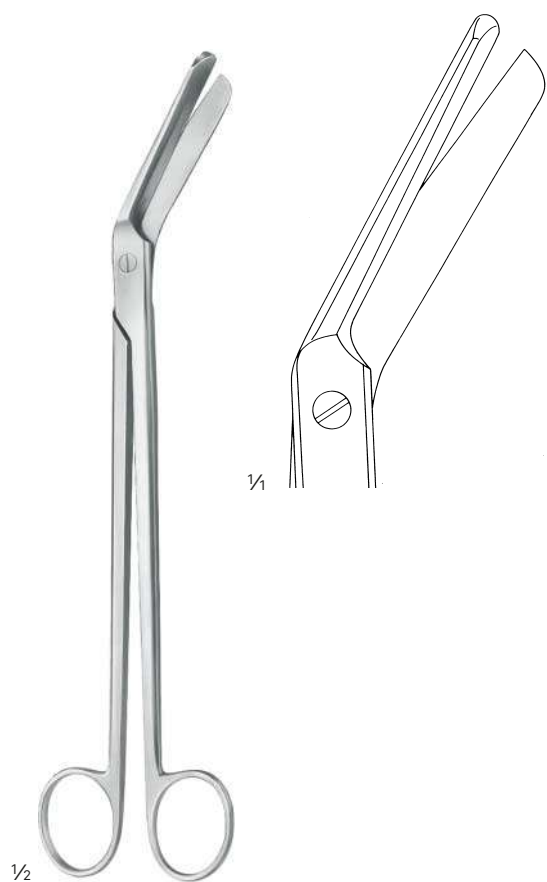

1/4

1/2

Braun-Stadler
MA 453-22
22 cm / 8⁵/₈"



Scissors
Umbilical Scissors



1/2

Mod. USA
MA 456-10
10,5 cm / 4 1/8"

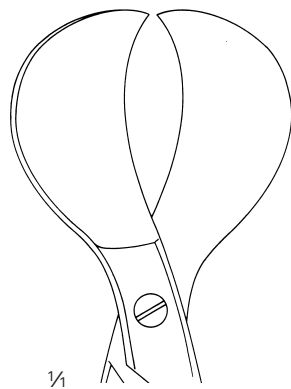

1/4



1/2

Busch
MA 458-16
16 cm / 6 2/8"

one toothed cutting edge

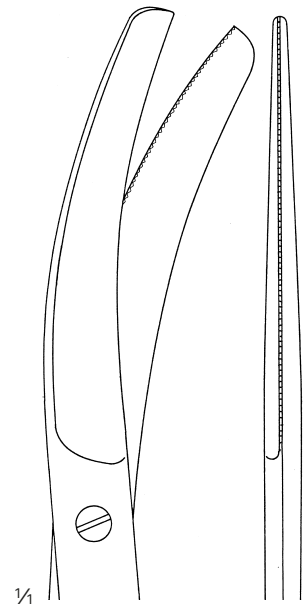

1/4

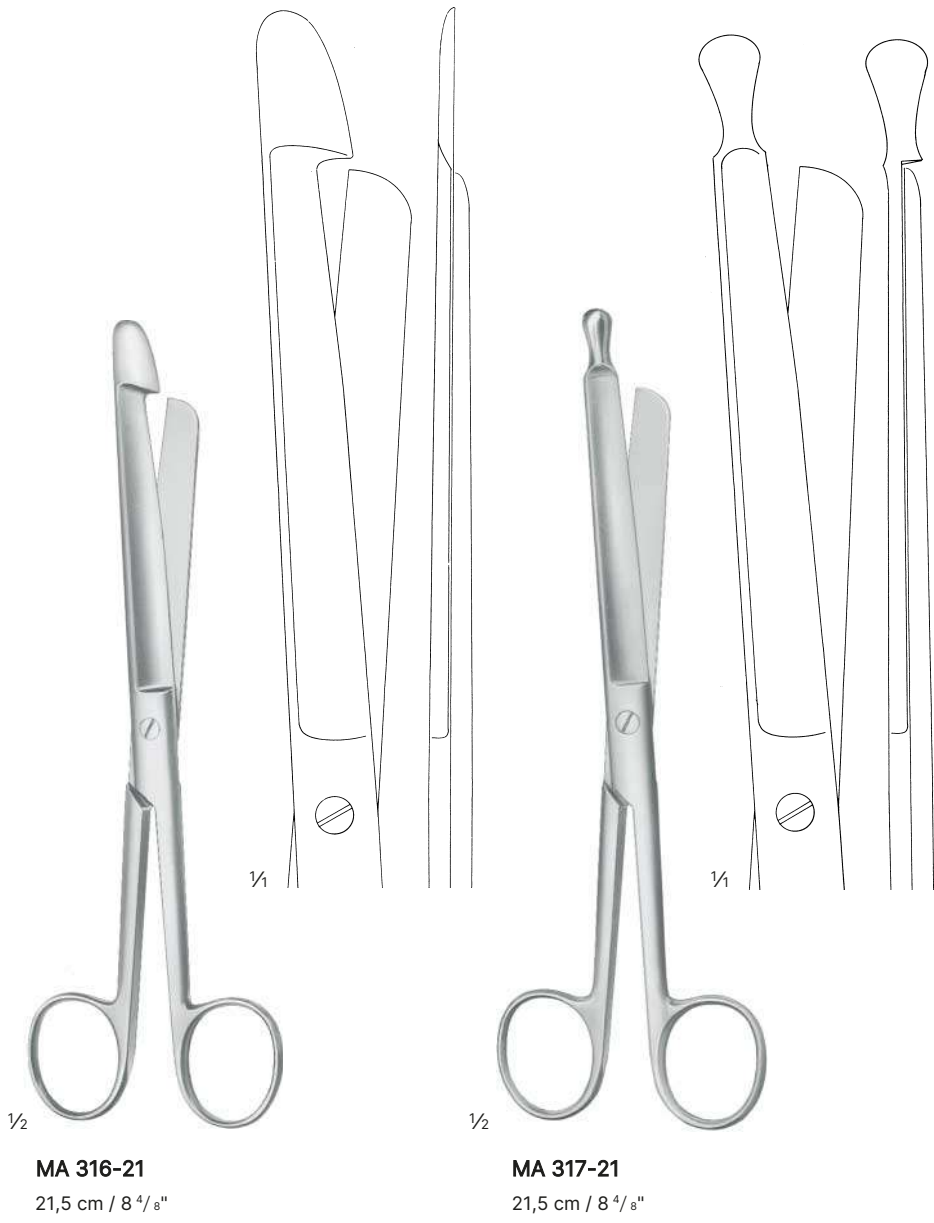

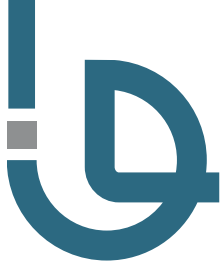

Scissors

Bandage Scissors



Lister

MA 636-14 14,5 cm / 5 ⁶/₈"

MA 636-18 18,5 cm / 7 ²/₈"

MA 636-20 20 cm / 7 ⁷/₈"

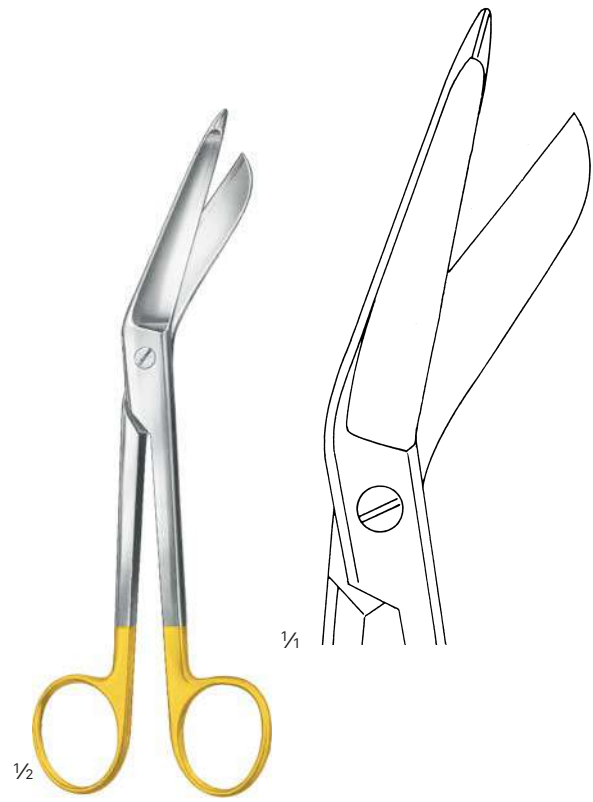

Lister



MA 890-18

18 cm / 7 ¹/₈"

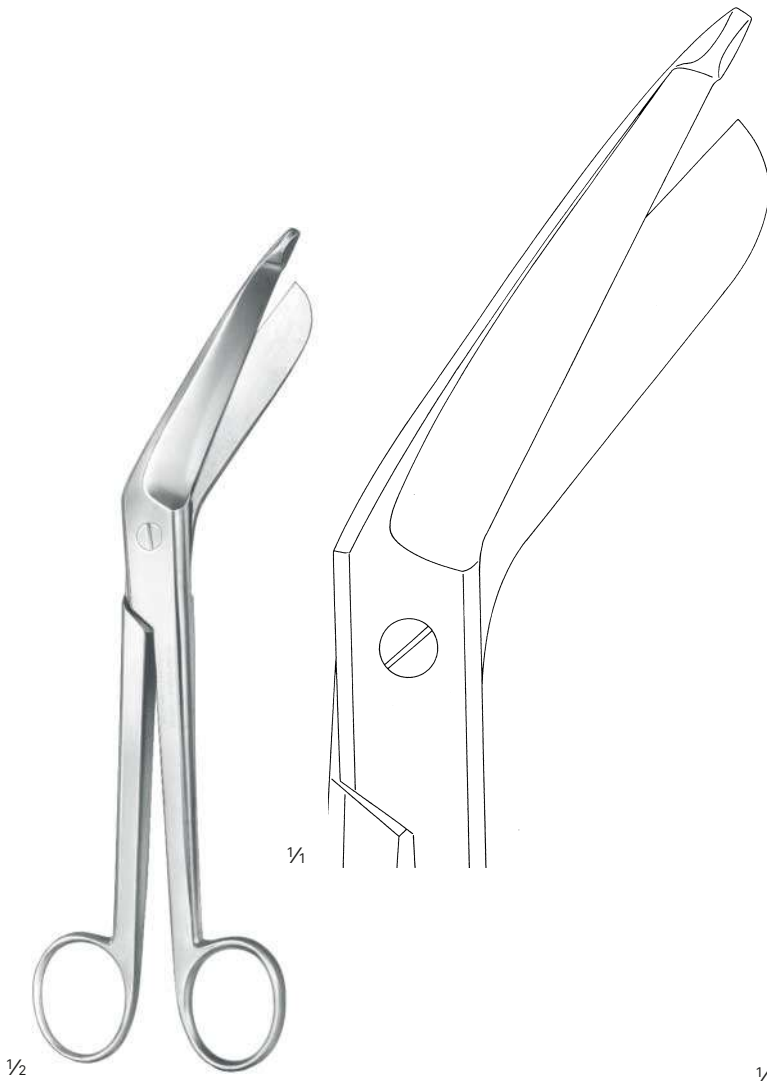

Bergmann
MA 620-23
23 cm / 9"
heavy pattern

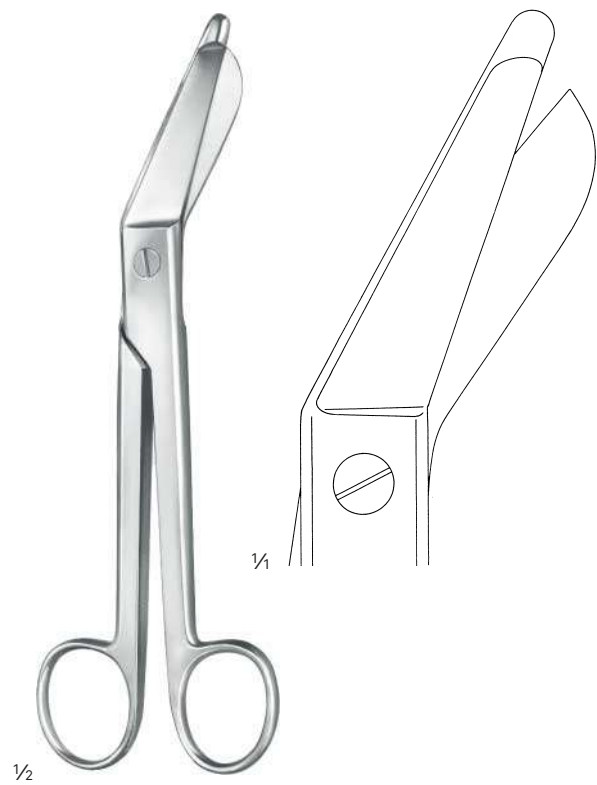

Esmarch
MA 637-20
20 cm / 7 7/8"
heavy pattern, short blades



Scissors
Plaster Shears

one toothed cutting edge



1/2

Bruns
24 cm / 9 1/8"

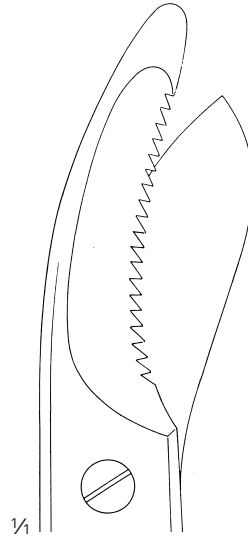

MA 640-24



MA 641-24

Forceps

Micro Forceps

Delicate Dissecting Forceps

Delicate Tissue Forceps

Dissecting Forceps

Tissue Forceps

Aturamatic Forceps



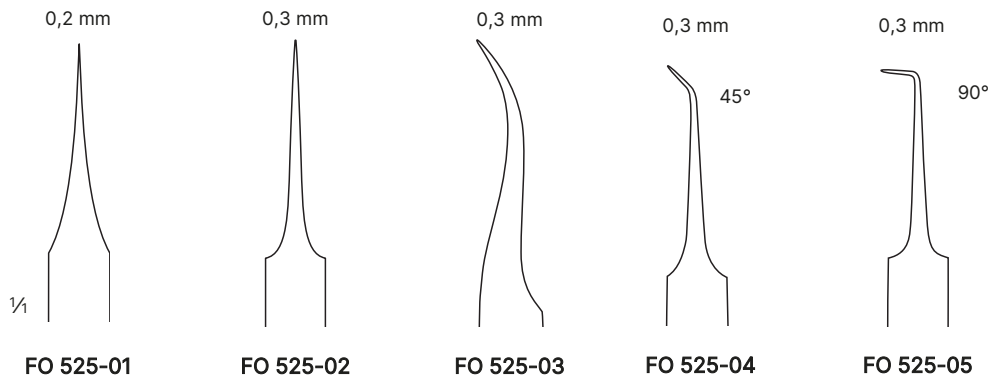

Jeweler Type
10,5 cm / 4 1/8"

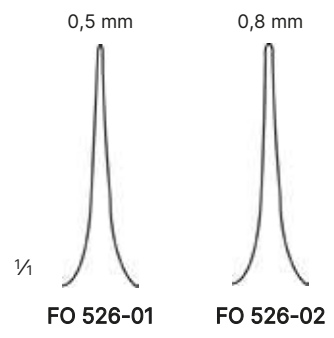

Lazar
15,5 cm / 6 1/8"



Lazar
18,5 cm / 7 1/4"



1/2

Jeweler Type

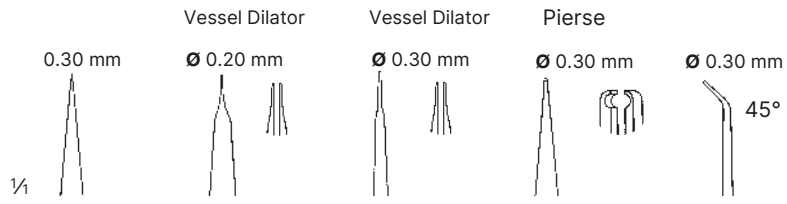

- | | | | | | |
|------------------|------------------|------------------|------------------|------------------|------------------|
| 11 cm / 4 3/8" | FO 530-00 | | | FO 530-04 | FO 530-07 |
| 13,5 cm / 5 3/8" | FO 530-01 | FO 530-02 | FO 530-03 | FO 530-05 | FO 530-08 |



1/2

Jeweler mod.

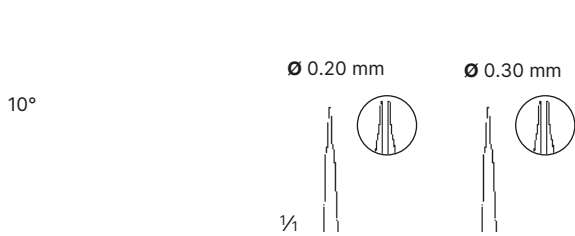

- | | | |
|----------------|------------------|------------------|
| 11 cm / 4 3/8" | FO 530-09 | FO 530-10 |
|----------------|------------------|------------------|

delicate



1/2



1x2

- | | | |
|------------------------------------|------------------------------------|-------------------------------------|
| FO 511-10 10 cm / 3 9/8" | FO 512-10 10 cm / 3 7/8" | FO 513-10 9,5 cm / 3 6/8" |
| FO 514-10 10 cm / 3 7/8" | FO 515-10 10 cm / 3 7/8" | FO 516-10 9,5 cm / 3 6/8" |

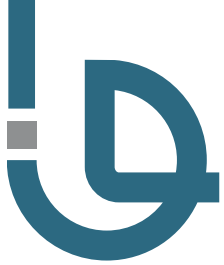

Atraumatic  1x2

1.2 mm

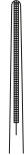

Ø1.0 x 0.5 mm



1/4



Ø2.0 x 0.8 mm



15 cm / 5 7/8"

FO 990-15

FO 991-15

FO 992-15

18 cm / 7 1/8"

FO 990-18

FO 991-18

FO 992-18

21 cm / 8 2/8"

FO 990-21

FO 991-21

FO 992-21



Ø 0.40 mm



1/4



0.40 mm



0.70 mm



0.70 mm



15 cm / 5 7/8"

FO 993-15

FO 994-15

FO 995-15

FO 996-15

18 cm / 7 1/8"

FO 993-18

FO 994-18

FO 995-18

FO 996-18

21 cm / 8 2/8"

FO 993-21

FO 994-21

FO 995-21

FO 996-21

Regular

with tying platform

0.30 mm



1/4

0.30 mm



0.60 mm



0.60 mm



12 cm / 5 7/8"

FO 608-12

FO 609-12

15 cm / 5 7/8"

FO 610-15

FO 611-15

18 cm / 7 1/8"

FO 612-18

FO 613-18

1/4



Atraumatic ^{1x2}

1.2 mm



15 cm / 5 7/8"

FO 980-15

18 cm / 7 1/8"

FO 980-18

21 cm / 8 1/4"

FO 980-21



Ø 1.0 x 0.5 mm



FO 981-15

FO 981-18

FO 981-21



Ø2.0 x 08 mm



FO 982-18



0.40 mm



15 cm / 5 7/8"

FO 983-15

18 cm / 7 1/8"

FO 983-18

21 cm / 8 1/4"

FO 983-21



0.40 mm



FO 984-15

FO 984-18

FO 984-21



0.70 mm



FO 985-15

FO 985-18

FO 985-21



0.70 mm



FO 986-15

FO 986-18

FO 986-21

Counter Balanced

1/4

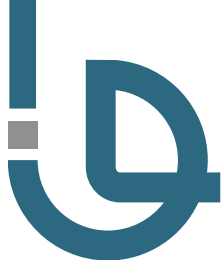

Forceps

Micro Forceps

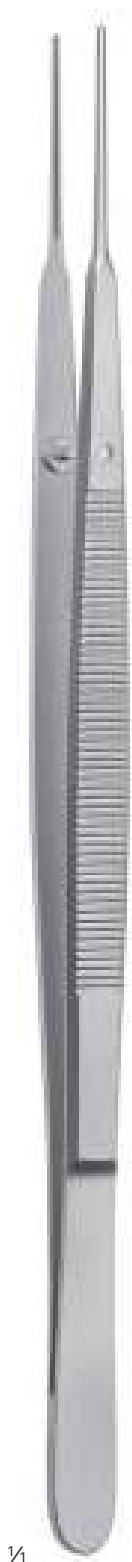

Gerald

Atraumatic 

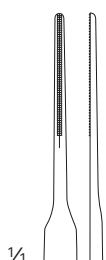

1,5 mm

DIAGRIP 



1,0 mm

DIAGRIP 

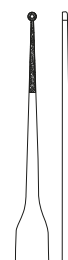

Ø 1.0 x 0.5 mm

Regular

cross serrated



1,0 mm

18 cm / 7¹/₈"

FO 961-18

FO 962-18

FO 963-18

FO 964-18

20 cm / 7⁷/₈"

FO 961-20

FO 962-20

FO 963-20

25 cm / 7¹/₈"

FO 964-25



1/2

standard pattern

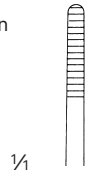

1/4

FO 100-10

10,5 cm / 4 1/8"



FO 100-11

11,5 cm / 4 2/8"

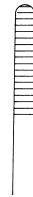

FO 100-13

13 cm / 5 1/8"

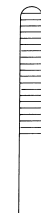

FO 100-14

14,5 cm / 5 6/8"

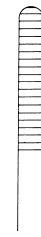

FO 100-16

16 cm / 6 2/8"



1/4

FO 100-18

18 cm / 7 1/8"

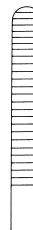

FO 100-20

20 cm / 7 7/8"

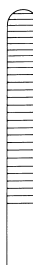

FO 100-25

25 cm / 9 7/8"

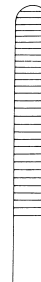

FO 100-30

30,5 cm / 12"



1/2

medium width



1/4

FO 120-10

10,5 cm / 4 1/8"



FO 120-11

11,5 cm / 4 2/8"



FO 120-13

13 cm / 5 1/8"



FO 120-14

14,5 cm / 5 5/8"



FO 120-16

16 cm / 6 2/8"

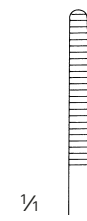

1/4

FO 120-18

18 cm / 7 1/8"

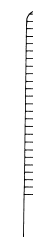

FO 120-20

20 cm / 7 7/8"



FO 120-25

25 cm / 9 7/8"



FO 120-30

30 cm / 11 6/8"

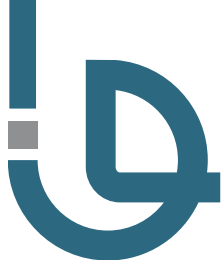

Forceps

Tissue Forceps

standard pattern



1x2



1/2

1/4



FO 110-10
10,5 cm / 4 1/8"



FO 110-11
11,5 cm / 4 2/8"



FO 110-13
13 cm / 5 1/8"



FO 110-14
14,5 cm / 5 6/8"



FO 110-16
16 cm / 6 2/8"

1/4



FO 110-18
18 cm / 7 1/8"



FO 110-20
20,5 cm / 8 1/8"



FO 110-25
25 cm / 9 7/8"



FO 110-30
30,5 cm / 12"

medium width



1x2



1/2

1/4



FO 130-13
13 cm / 5 1/8"



FO 130-14
14,5 cm / 5 5/8"



FO 130-16
16 cm / 6 2/8"



FO 130-18
18 cm / 7 1/8"

1/4



FO 130-20
20,5 cm / 8 1/8"



FO 130-25
25 cm / 9 7/8"



FO 130-30
30 cm / 11 6/8"

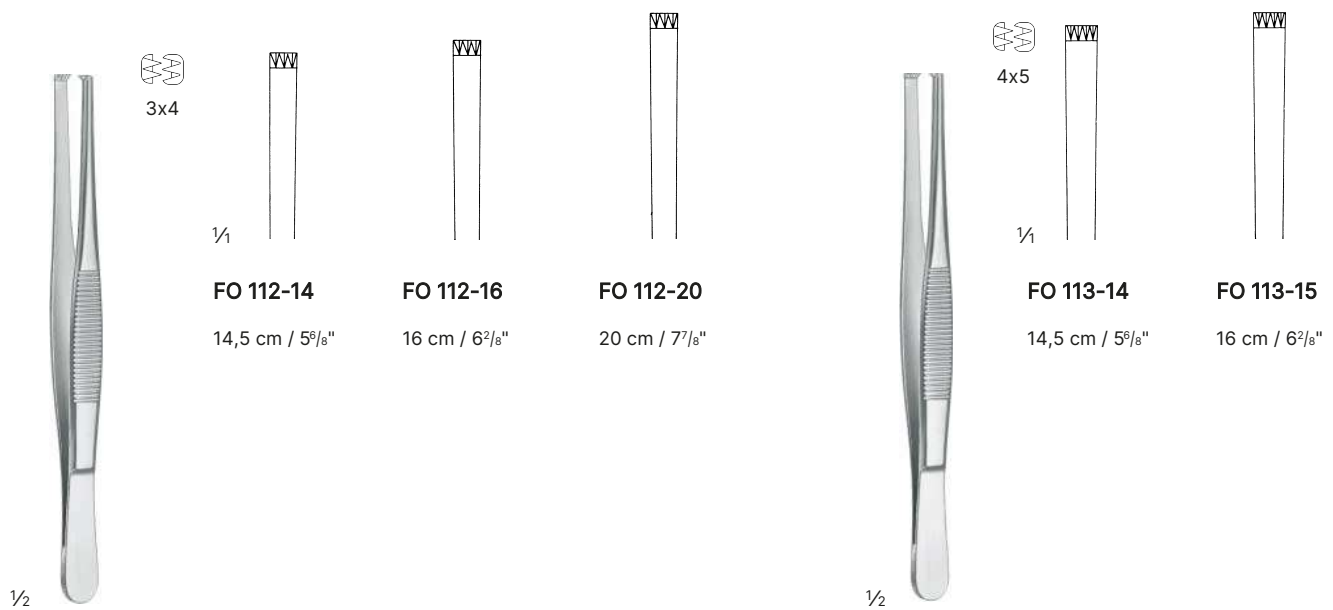
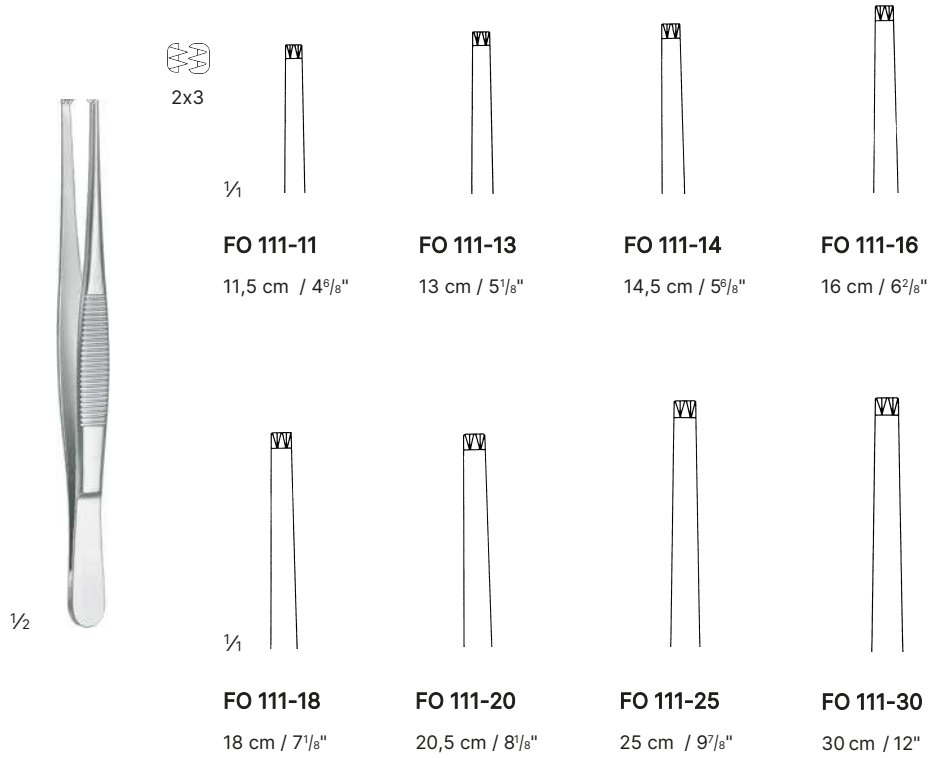



Forceps

Dissecting Forceps, Tissue Forceps

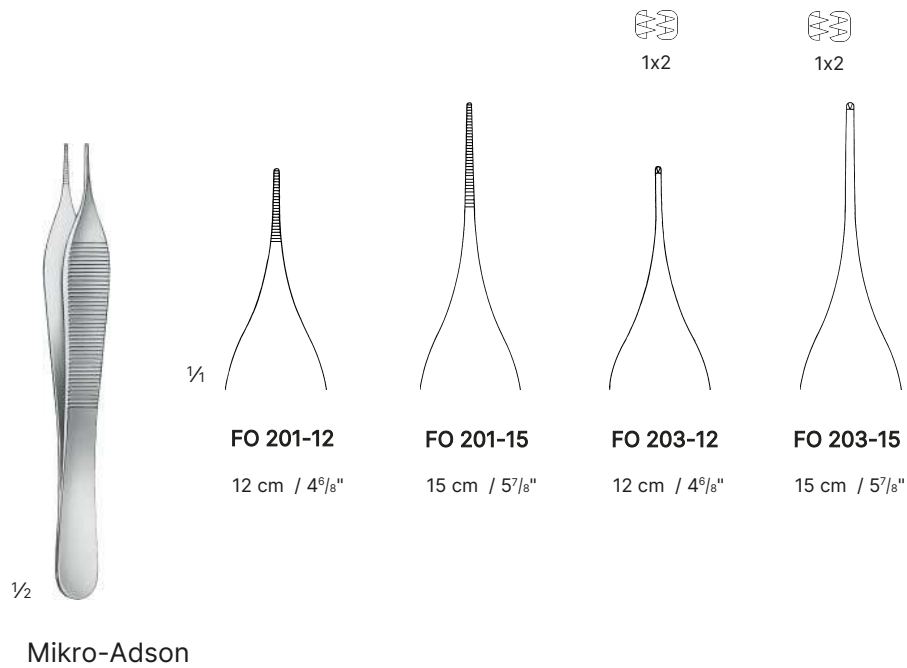
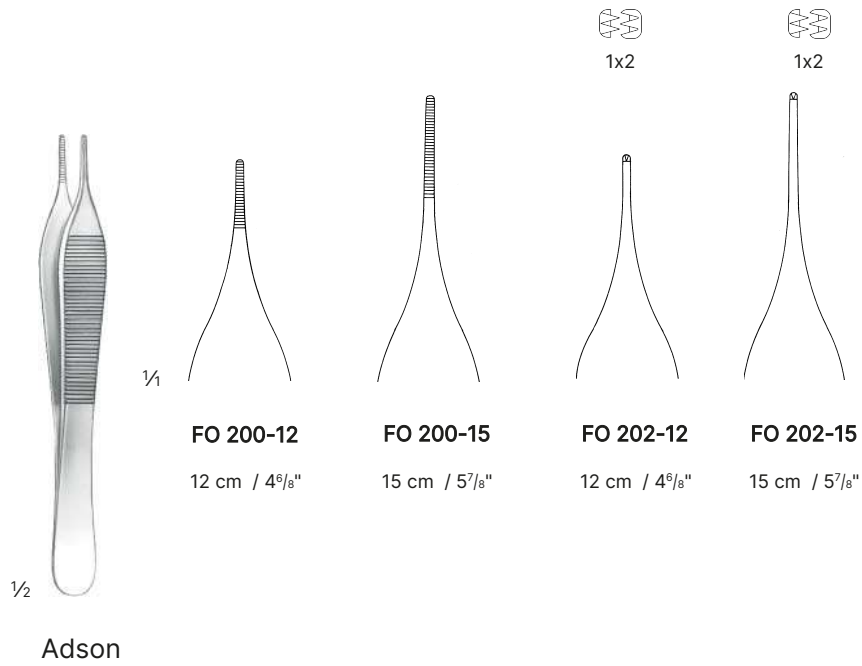



1x2

cross serrated

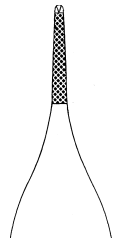

FO 207-12

12 cm / 4 3/4"

0.8 mm

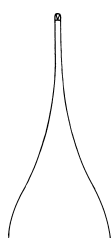

FO 208-12

12 cm / 4 3/4"

1.2 mm

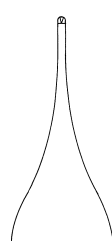

FO 209-12

12 cm / 4 3/4"

1.5 mm

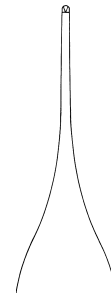

FO 209-15

15 cm / 6"

Adson



cross serrated

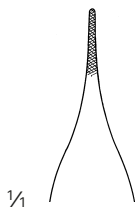

FO 220-12

1/2



1x2

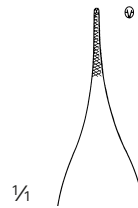

FO 221-12

1/2

1/2

Mini-Adson

12 cm / 4 5/8"



1/2

Adson-Brown

12 cm / 4 5/8"

7x7



FO 222-07

1/2

9x9

FO 222-09

9x9

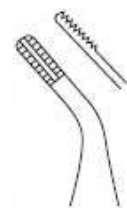

FO 223-09

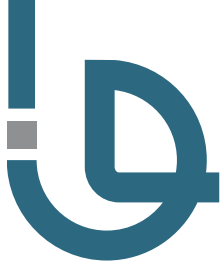

Forceps

Dissecting Forceps, Tissue Forceps

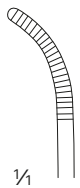

1/4

FO 121-14



1x2



1/4

FO 131-14

1/2

14,5 cm / 5 7/8"



1/4

1/2

McIndoe

FO 225-15

15 cm / 5 7/8"

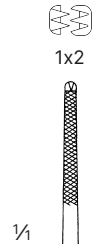

1/4

1x2

1/2

Gillies

FO 510-15

15,5 cm / 6 1/8"



1/2

Semken

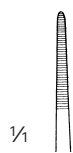

1/4

FO 226-12

12,5 cm / 4 7/8"

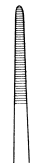

FO 226-15

15 cm / 5 7/8"

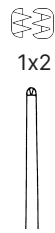

1x2

FO 228-12

12,5 cm / 4 7/8"



1x2

FO 228-15

15 cm / 5 7/8"



1/4

FO 227-12

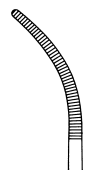

FO 227-15



1x2

FO 229-12



1x2

FO 229-15



Taylor
17,5 cm / 6⁷/₈"

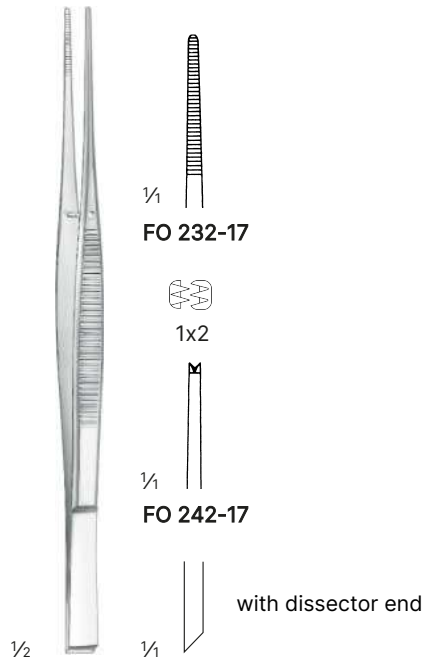

Taylor
17 cm / 6⁶/₈"

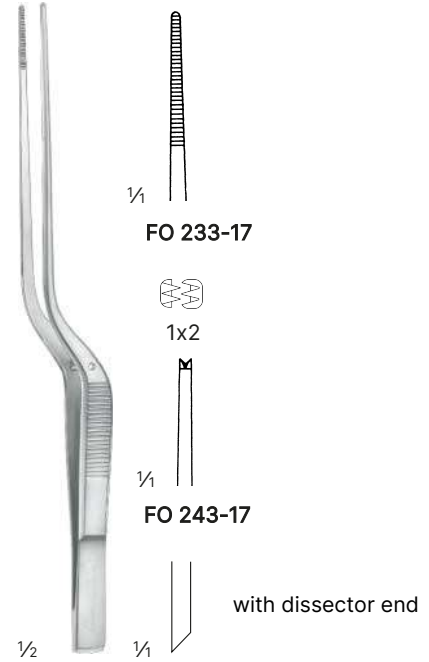

Taylor
18,5 cm / 7²/₈"

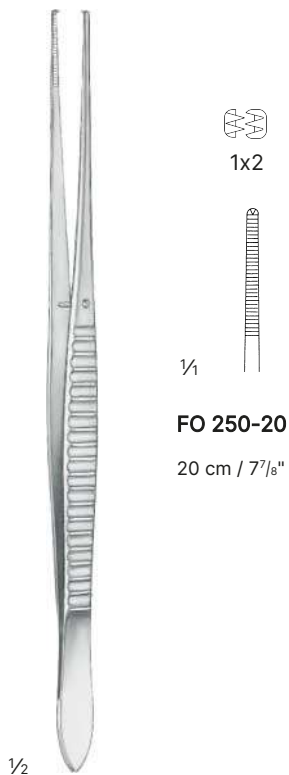

Waugh

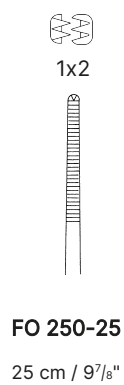

FO 250-25
25 cm / 9⁷/₈"

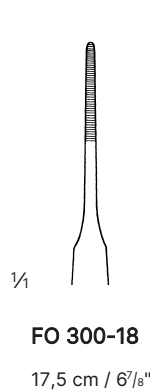

FO 300-18
17,5 cm / 6⁷/₈"

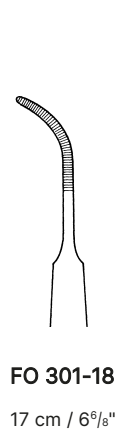

FO 301-18
17 cm / 6⁶/₈"

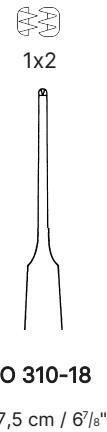

FO 310-18
17,5 cm / 6⁷/₈"

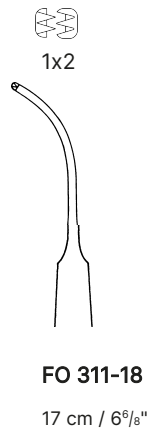

FO 311-18
17 cm / 6⁶/₈"

Gerald



Forceps

Dissecting Forceps, Tissue Forceps



1/2

Cushing

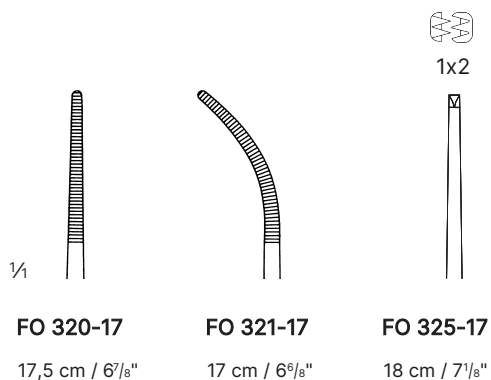

FO 320-17

17,5 cm / 6⁷/₈"

FO 321-17

17 cm / 6⁶/₈"

FO 325-17

18 cm / 7¹/₈"



1/2

Potts-Smith

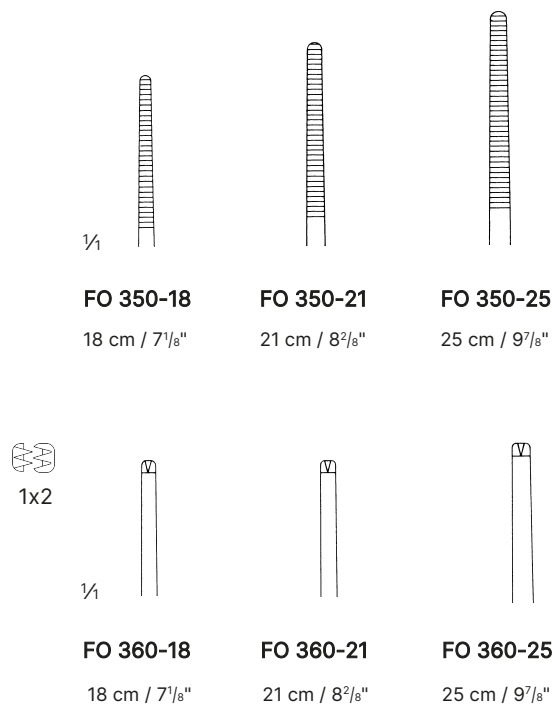

FO 350-18

18 cm / 7¹/₈"

FO 350-21

21 cm / 8²/₈"

FO 350-25

25 cm / 9⁷/₈"

FO 360-18

18 cm / 7¹/₈"

FO 360-21

21 cm / 8²/₈"

FO 360-25

25 cm / 9⁷/₈"



1/2

Brown

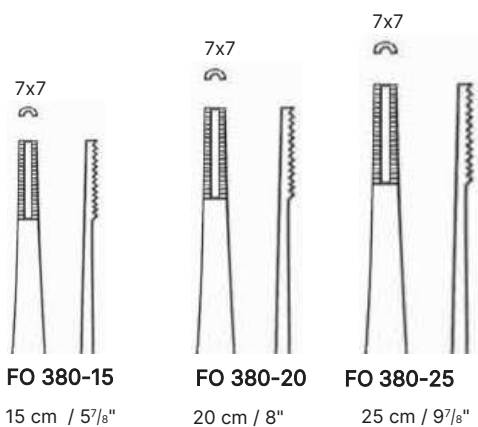

FO 380-15

15 cm / 5⁷/₈"

FO 380-20

20 cm / 8"

FO 380-25

25 cm / 9⁷/₈"



1/2

Ochner

FO 389-14

14,5 cm / 5³/₄"

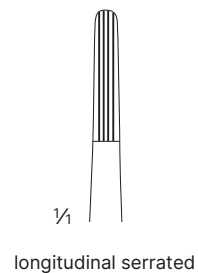

1/4

longitudinal serrated



1/2

Russ. Model



1/4

FO 517-15

15 cm / 5 7/8"



FO 517-20

20 cm / 7 7/8"



FO 517-25

25 cm / 9 3/8"



1/2

Mayo
FO 501-23
23 cm / 9"

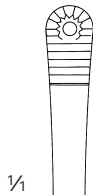

1/4



1/2

Singley-Tuttle
FO 502-23
23 cm / 9"

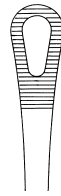

1/4



1/2

Nelson
FO 503-23
23 cm / 9"

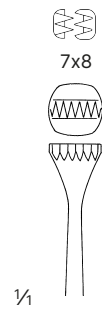

1/4

7x8



Forceps
Tissue Forceps



1/2

Durante

1/4

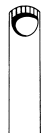

FO 518-14
14,5 cm / 5 5/8"



FO 518-16
16 cm / 6 2/8"



FO 518-20
20 cm / 7 7/8"



1/2

Duval
FO 519-14
14,5 cm / 5 5/8"

1/4

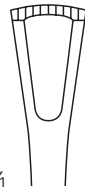

1/4



1x2



1/2

Bonney
FO 520-18
17,5 cm / 6 7/8"

 TC



1/2



0.5



FO 399-14

14,5 cm / 5 7/8"



FO 399-20

20 cm / 8"

FO 399-18

18 cm / 7"

FO 399-25

25 cm / 9 3/4"



1/2

Potts-Smith



0.5



FO 400-15

16 cm / 6 2/8"



FO 400-18

18,5 cm / 7 2/8"



FO 400-20

20 cm / 7 7/8"



FO 400-23

23 cm / 9"



FO 400-25

25 cm / 9 7/8"



1/2

Adson



0.5

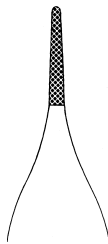

1/4

FO 405-12

12 cm / 4 6/8"

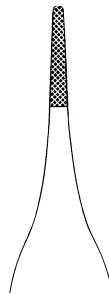

FO 405-15

15 cm / 5 7/8"



1x2

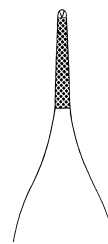

FO 406-12

12 cm / 4 6/8"



1x2

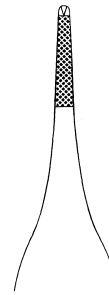

FO 406-15

15 cm / 5 7/8"



Forceps

Tissue Forceps, Dissecting Forceps

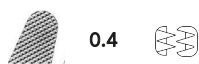

1/2

Gillies

FO 403-15

15,5 cm / 6 1/8"



1/2

McIndoe

FO 407-15

15 cm / 5 7/8"

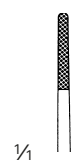

1/2

Cushing

FO 407-17

17,5 cm / 6 7/8"

1/4



1/2

Cushing

FO 408-17

17 cm / 6 5/8"

1/4



1/2

Cushing-Taylor

FO 409-18

18,5 cm / 7 1/8"

1/4

TC



1x2



0.5



1/2

Oehler



FO 401-14
14,5 cm / 5⁶/₈"



FO 401-16
16 cm / 6²/₈"



FO 401-18
18 cm / 7¹/₈"



FO 401-20
20 cm / 7⁷/₈"



FO 401-25
25 cm / 9⁷/₈"

Atraumatic

1x2



0.4



1/2

DeBaKey

1/4



1,5 mm

16 cm / 6²/₈"

FO 410-16

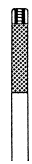

2,0 mm

FO 411-16



2,7 mm

FO 412-16



3,5 mm

FO 413-16

20 cm / 7⁷/₈"

FO 410-20

FO 411-20

FO 412-20

FO 413-20

24 cm / 9³/₈"

FO 410-24

FO 411-24

FO 412-24

FO 413-24



Forceps
Atraumatic Forceps

Atraumatic ^{1x2}

1,5 mm

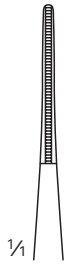

1/4

FO 950-16
16 cm / 6²/₈"

1,5 mm

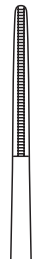

FO 950-20
20 cm / 7⁷/₈"

1,5 mm

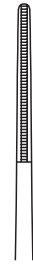

FO 950-24
24 cm / 9³/₈"

2,0 mm

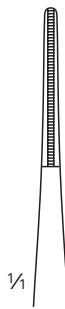

1/4

FO 951-16
16 cm / 6²/₈"

2,0 mm



FO 951-20
20 cm / 7⁷/₈"

2,0 mm



FO 951-24
24 cm / 9³/₈"

2,0 mm

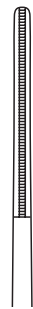

FO 951-30
30 cm / 11⁶/₈"

2,7 mm

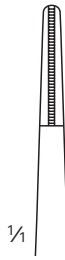

1/4

FO 952-16
16 cm / 6²/₈"

2,7 mm

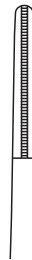

FO 952-20
20 cm / 7⁷/₈"

2,7 mm

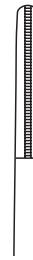

FO 952-24
24 cm / 9³/₈"

2,7 mm



FO 952-30
30 cm / 11⁶/₈"



1/2

De Bakey

3,5 mm

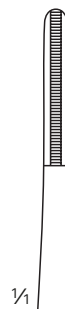

1/4

FO 953-16
16 cm / 6²/₈"

3,5 mm



FO 953-20
20 cm / 7⁷/₈"

3,5 mm



FO 953-24
24 cm / 9³/₈"

3,5 mm



FO 953-30
30 cm / 11⁶/₈"

Atraumatic ^{1x2}



1/2

De Bakey

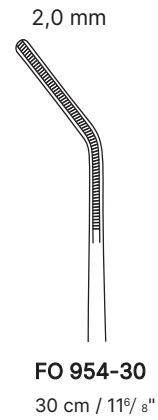
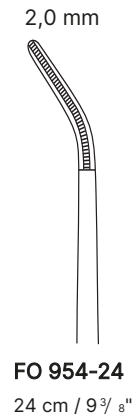
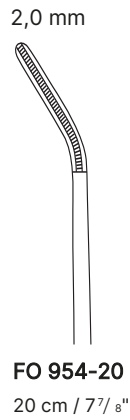
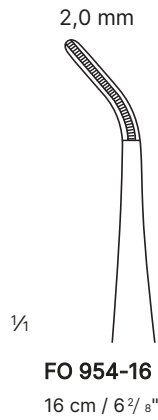

1/2

De Bakey Ultra-Light

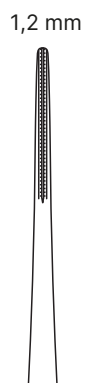

Sponge and Dressing Clamps

Dressing Clamps
Sponge Holding
Clamps Towel Clamps





Sponge and Dressing Clamps

Sponge Holding and Dressing Clamps

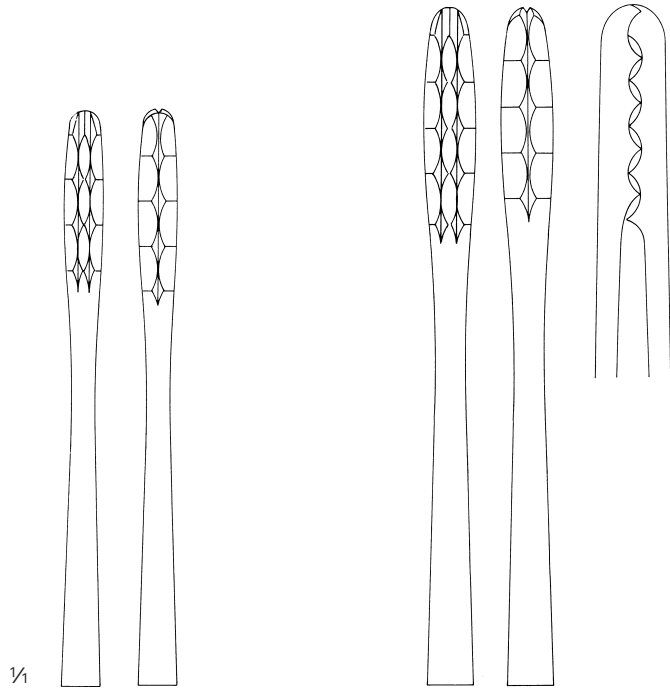

CM 201-22
22,5 cm / 8 ⁷/₈"

CM 201-25
27 cm / 10 ⁵/₈"



1/2

Ulrich

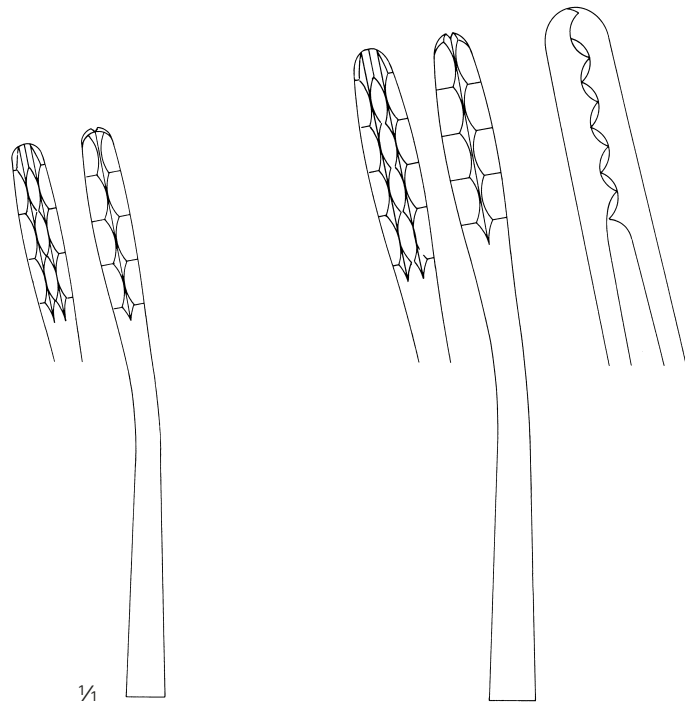

CM 202-22
22,5 cm / 8 ⁷/₈"

CM 202-25
26,5 cm / 10 ⁷/₈"



1/2

Gross-Maier

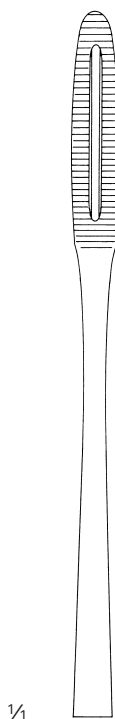

1/4

CM 205-20
20,5 cm / 8 1/8"

CM 205-22
22,5 cm / 8 7/8"

CM 205-25
25 cm / 9 7/8"

CM 205-27
26,5 cm / 10 3/8"

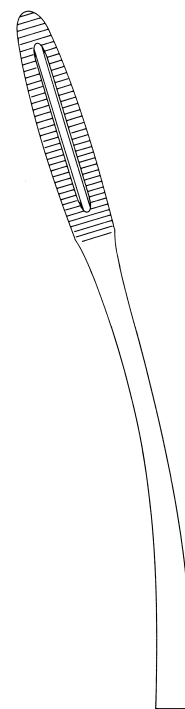

CM 206-20
20,5 cm / 8 1/8"

CM 206-22
22,5 cm / 8 7/8"

CM 206-25
25 cm / 9 7/8"

CM 206-27
26,5 cm / 10 3/8"



Sponge and Dressing Clamps

Sponge Holding Clamp

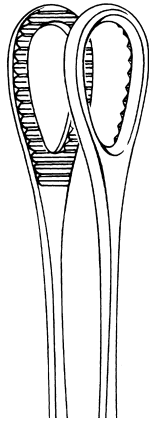

CM 223-18
18 cm / 7 1/8"

CM 223-20
20,5 cm / 8 1/8"

CM 223-25
25 cm / 9 7/8"

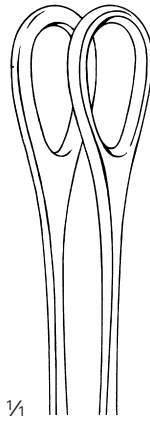

1/1

CM 225-25
25 cm / 9 7/8"
smooth jaw

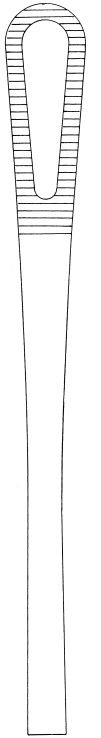

1/1

CM 229-25
25 cm / 9 7/8"



1/2

Foester-Ballanger

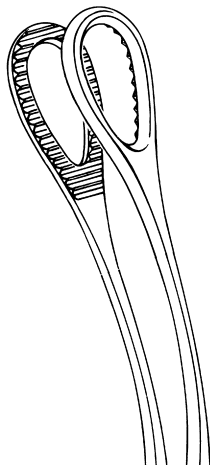

CM 224-18
18 cm / 7 1/8"

CM 224-20
20 cm / 7 7/8"

CM 224-25
25 cm / 9 1/8"

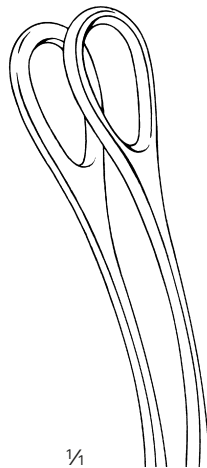

1/1

CM 226-25
25 cm / 9 7/8"
smooth jaw



1/2

Rampley



Lane

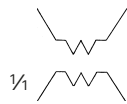

HM 840-13

13 cm / 5 1/8"

HM 840-15

15 cm / 5 7/8"

HM 840-20

19,5 cm / 7 5/8"

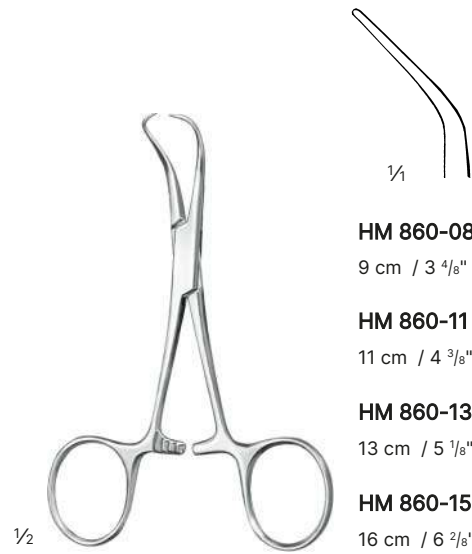

Backhaus
sharp

HM 860-08

9 cm / 3 4/8"

HM 860-11

11 cm / 4 3/8"

HM 860-13

13 cm / 5 1/8"

HM 860-15

16 cm / 6 2/8"



Bernhard
HM 835-16

16,5 cm / 6 4/8"
sharp



HM 861-13

14 cm / 5 4/8"
for paper drapes



Roeder
HM 880-13

13,5 cm / 5 3/8"

Clamps

Approximators

Micro Bulldog Clamps

Bulldog Clamps

Hemostatic Clamps

Dissecting and Ligature Clamps

Bile Duct Clamps

Kidney Pedicle Clamps

Peritoneum Clamps

Hysterectomy Clamps



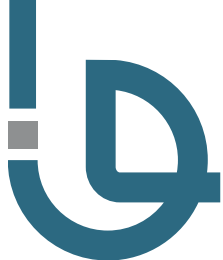

Clamps

Applying Forceps, Micro Bulldog Clamps, Approximator



1/2



HM 482-01
HM 483-05



1/4

Biemer

Total length:

Jaw length:



1/4

HM 482-01

14 mm

6 mm



HM 482-02

17 mm

9 mm



HM 482-03

17 mm

9 mm

HM 482-00

14,5 cm / 5 9/16"



1/4

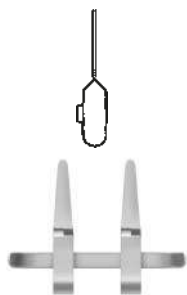

1/4

Biemer-Müller

straight, wide

HM 483-01

Total length:

Jaw length:

17 mm

9 mm



angled, wide

HM 483-02

17 mm

9 mm

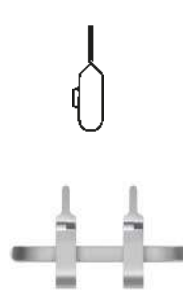

straight, narrow

HM 483-03

13 mm

4,5 mm

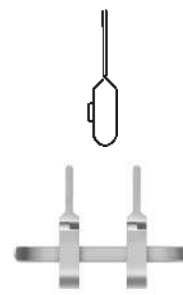

straight, narrow

HM 483-04

17 mm

9 mm

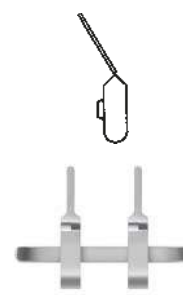

angled, narrow

HM 483-05

17 mm

9 mm

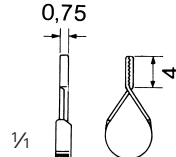
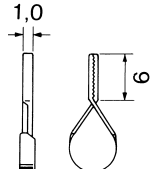
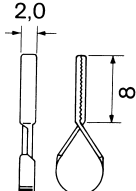
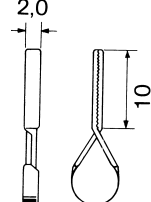
| | | | | |
|---|---|---|--|---|
|  |  |  |  |  |
| $\frac{1}{4}$ | $\frac{1}{4}$ | | | |
| | HM 484-01 | HM 484-02 | HM 484-03 | HM 484-04 |
| Total length: | 1,3 cm | 1,5 cm | 1,7 cm | 2,0 cm |
| Jaw length: | 4 mm | 6 mm | 8 mm | 10 mm |



 **HM 484-01**
HM 484-04

$\frac{1}{2}$
HM 484-00
18,5 cm / 7 ²/₈"

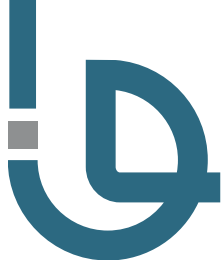

Clamps

Bulldog Clamps



Diethrich

Total length:

Jaw length:

1/4



HM 470-01

4,5 cm / 1 7/16"

8 mm

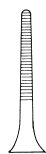

HM 470-02

5,0 cm / 1 11/16"

12 mm

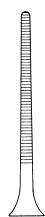

HM 470-03

6,0 cm / 2 3/8"

20 mm



HM 471-01

4,0 cm / 1 5/8"

8 mm

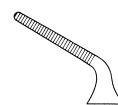

HM 471-02

4,5 cm / 1 7/16"

12 mm

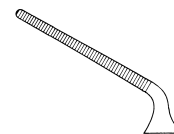

HM 471-03

5,0 cm / 1 11/16"

20 mm



1/2

Total length:

Jaw length:

1/4



HM 476-03

3,5 cm / 1 3/8"

11 mm



HM 476-05

5 cm / 2"

15 mm



HM 476-06

6 cm / 2 3/8"

17 mm



HM 477-03

3,5 cm / 1 3/8"

11 mm



HM 477-05

5 cm / 2"



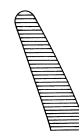



15 mm





HM 477-06

6 cm / 2 3/8"

17 mm

| | | | | | |
|---|---|---|---|---|---|
|  |  |  |  |  |  |
| 1/2 | 1/4 | | | | |
| Johns-Hopkins | HM 480-04 | HM 480-05 | HM 480-06 | HM 480-07 | HM 480-09 |
| Total length: | 3,8 cm / 1 3/8" | 5,5 cm / 2 1/8" | 6,5 cm / 2 4/8" | 7,5 cm / 3" | 9 cm / 3 4/8" |
| Jaw length: | 12 mm | 25 mm | 30 mm | 40 mm | 50 mm |

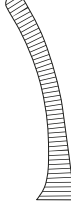
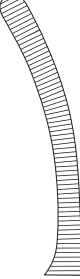
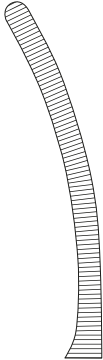
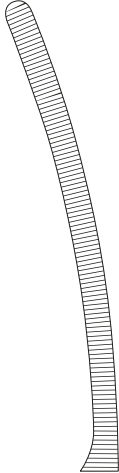
| | | | | | |
|---|---|---|---|--|---|
|  |  |  |  |  |  |
| 1/2 | 1/4 | | | | |
| Johns-Hopkins | HM 481-04 | HM 481-05 | HM 481-06 | HM 481-07 | HM 481-09 |
| Total length: | 3,8 cm / 1 3/8" | 5,5 cm / 2 1/8" | 6,5 cm / 2 4/8" | 7,5 cm / 3" | 9 cm / 3 4/8" |
| Jaw length: | 12 mm | 25 mm | 30 mm | 40 mm | 50 mm |

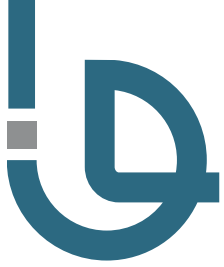

Clamps

Applying Forceps for Bulldog Clamps



HM 480-00

24 cm / 9 1/2"

Applying Forceps for Bulldog Clamps

Atraumatic



1/1

Mini-Glover

| | KA 100-01 | KA 100-02 | KA 100-03 | KA 100-04 |
|---------------|--|--|--|---|
| Total length: | 3,0 cm / 7 ¹⁰ / ₁₆ " | 3,5 cm / 8 ¹⁴ / ₁₆ " | 4,0 cm / 10 ³ / ₁₆ " | 5,0 cm / 12 ¹¹ / ₁₆ " |
| Jaw length: | 9 mm | 13 mm | 14 mm | 23 mm |



1/1

Mini-Glover

| | KA 100-05 | KA 100-06 | KA 100-07 | KA 100-08 |
|---------------|--|--|--|---|
| Total length: | 3,0 cm / 7 ¹⁰ / ₁₆ " | 3,5 cm / 8 ¹⁴ / ₁₆ " | 4,0 cm / 10 ³ / ₁₆ " | 5,0 cm / 12 ¹¹ / ₁₆ " |
| Jaw length: | 9 mm | 13 mm | 14 mm | 23 mm |



1/1

Mini-Glover

| | KA 100-09 | KA 100-10 | KA 100-11 | KA 100-12 |
|---------------|--|--|--|---|
| Total length: | 3,0 cm / 7 ¹⁰ / ₁₆ " | 3,5 cm / 8 ¹⁴ / ₁₆ " | 4,0 cm / 10 ³ / ₁₆ " | 5,0 cm / 12 ¹¹ / ₁₆ " |
| Jaw length: | 9 mm | 13 mm | 14 mm | 23 mm |

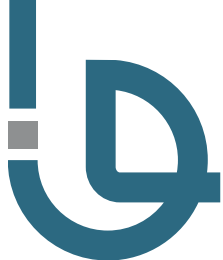

Clamps

Applying Forceps for Bulldog Clamps



1/2

Mini-Glover

KA 100-00

24 cm / 9 5/8"

Applying Forceps for Bulldog Clamps



1/2

Hartmann

10 cm / 3 7/8"

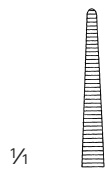

1/1

HM 432-10

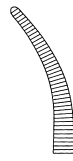

HM 433-10

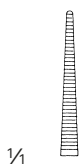

1/1

HM 436-10

10 cm / 3 7/8"



HM 436-12

12 cm / 4 6/8"



HM 437-10

10 cm / 3 7/8"



HM 437-12

12 cm / 4 6/8"



1/2

Mikro-Mosquito



1x2

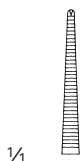

1/1

HM 438-10

10 cm / 3 7/8"

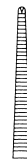

HM 438-12

12 cm / 4 6/8"



HM 439-10

10 cm / 3 7/8"



HM 439-12

12 cm / 4 6/8"



1/2

Halsted-Mosquito



1/1

HM 440-12

12,5 cm / 4 7/8"



HM 440-14

14,5 cm / 5 6/8"



HM 441-12

12 cm / 4 6/8"



HM 441-14

14 cm / 5 4/8"



1x2



1/1

HM 442-12

12,5 cm / 4 7/8"

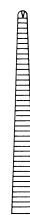

HM 442-14

14,5 cm / 5 6/8"



HM 443-12

12,5 cm / 4 7/8"



HM 443-14

14,5 cm / 5 6/8"



Clamps
Hemostatic Clamps

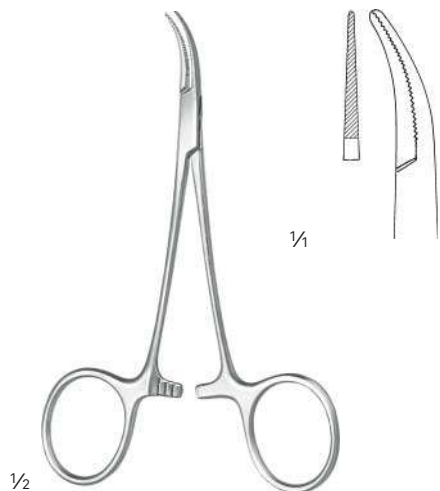

Dandy-Mosquito
HM 424-12
12 cm / 4 5/8"
laterally curved



HM 424-14
14,5 cm / 5 5/8"

Dandy
laterally curved

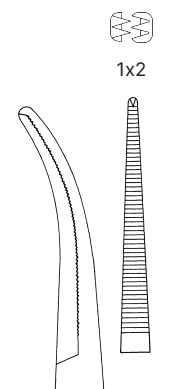

HM 425-14
14,5 cm / 5 5/8"



Providence-Hospital

HM 454-14
14 cm / 5 4/8"

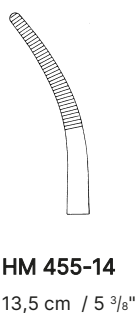

HM 455-14
13,5 cm / 5 3/8"



Kelly

HM 460-14
14,5 cm / 5 5/8"

HM 461-14
14 cm / 5 4/8"



Crile
14,5 cm / 5 6/8"

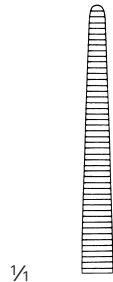

HM 466-14



HM 467-14



1x2



HM 468-14



1x2



HM 469-14



Leriche

1/4



HM 450-15
15,5 cm / 6 1/8"

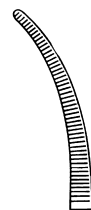

HM 451-15
15 cm / 5 7/8"



1x2

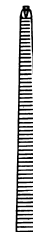

HM 452-15
15,5 cm / 6 1/8"



1x2

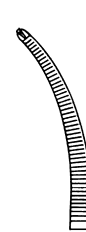

HM 453-15
15 cm / 5 7/8"



Clamps

Hemostatic Clamps

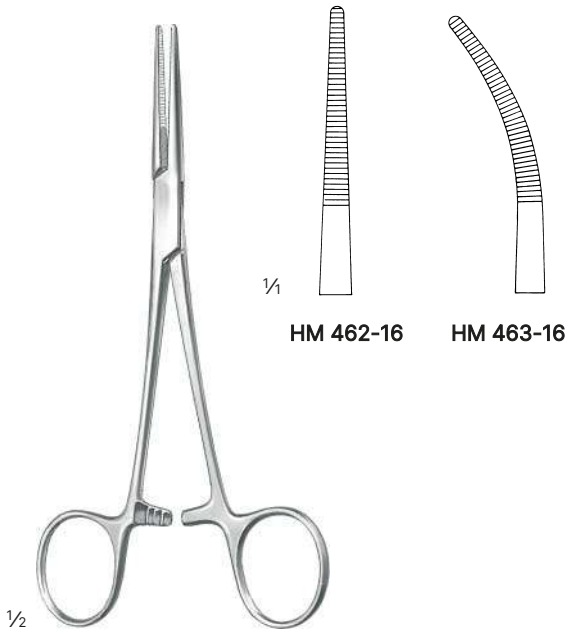

Kelly-Rankin
16 cm / 6 2/8"

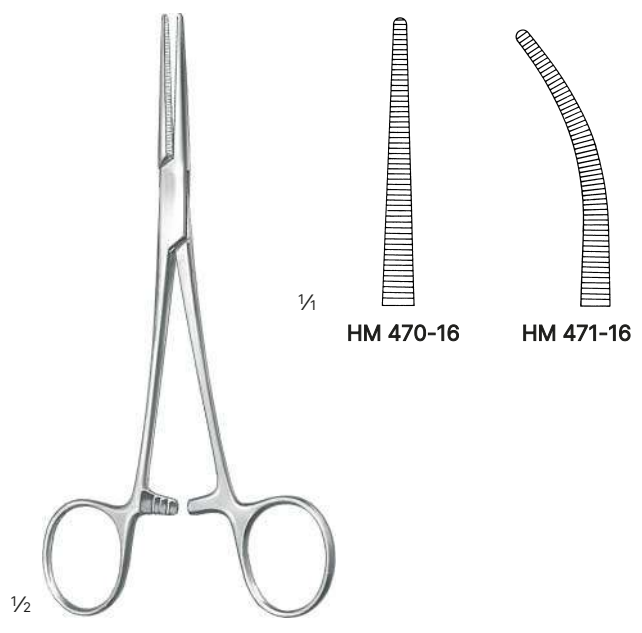

Crile-Rankin
16 cm / 6 2/8"

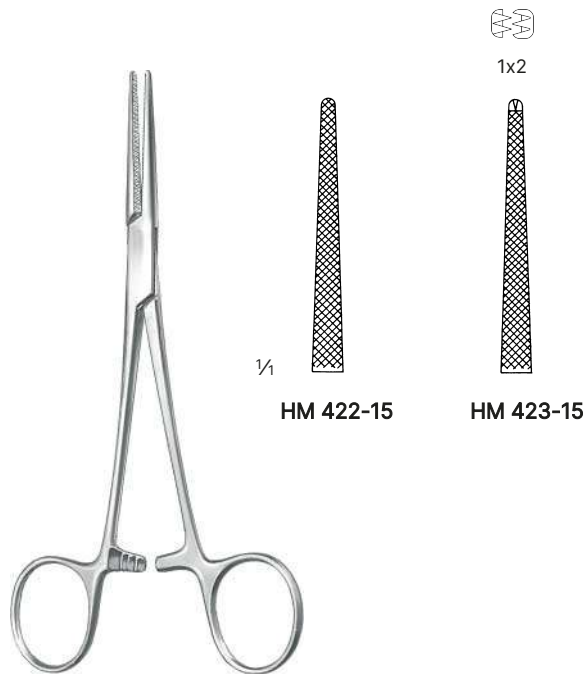

Lovelace
16 cm / 6 2/8"
cross serrated jaw

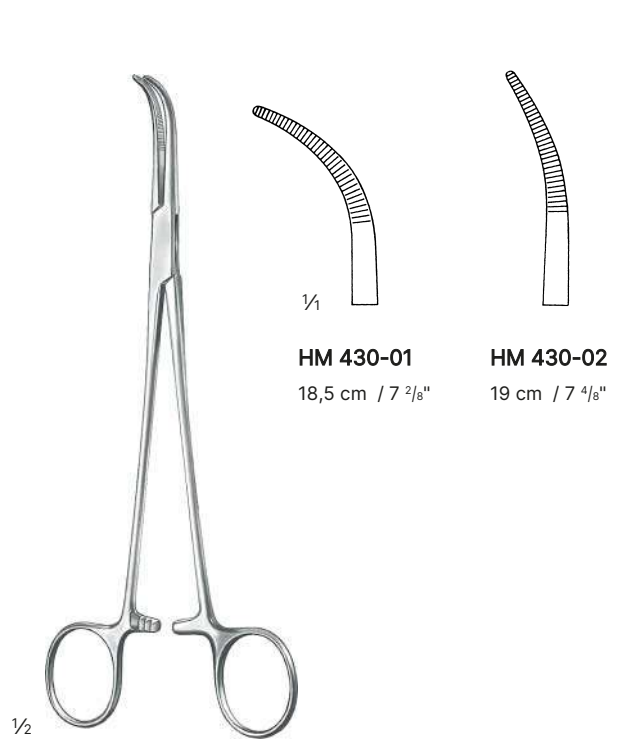

Schmidt-Sawtel

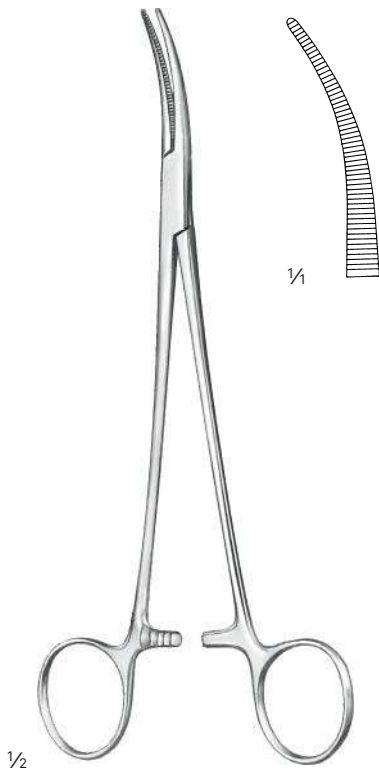

Fuchsig
HM 408-18
20,5 cm / 8 1/8"



Adson

HM 418-19
19 cm / 7 4/8"

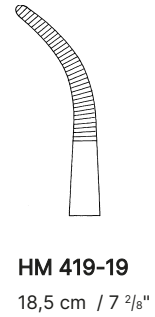

Halsted-Mosquito

1x2

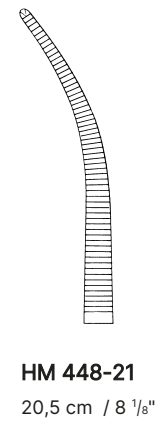
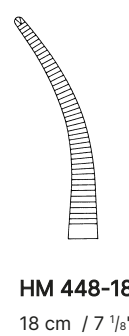
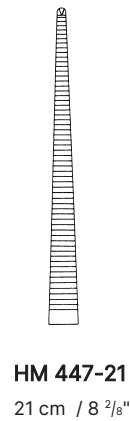
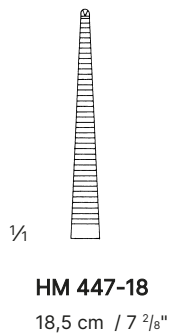
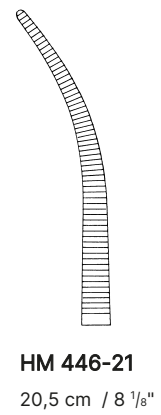
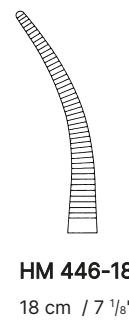
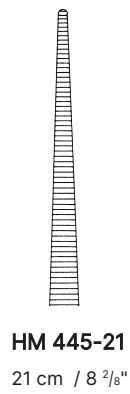
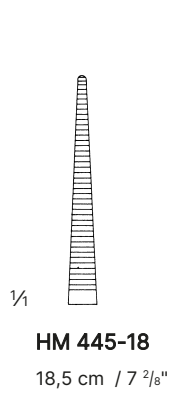



Clamps

Hemostatic Clamps



1/2

Bengolea

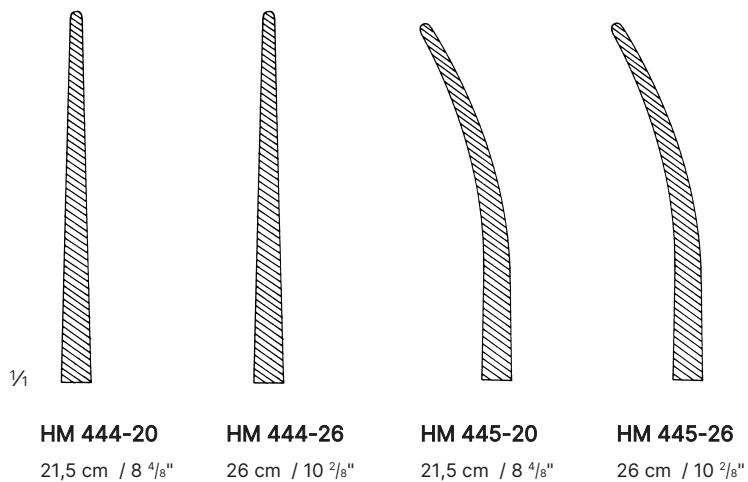

1/4

HM 444-20

21,5 cm / 8 4/8"

HM 444-26

26 cm / 10 2/8"

HM 445-20

21,5 cm / 8 4/8"

HM 445-26

26 cm / 10 2/8"



1x2

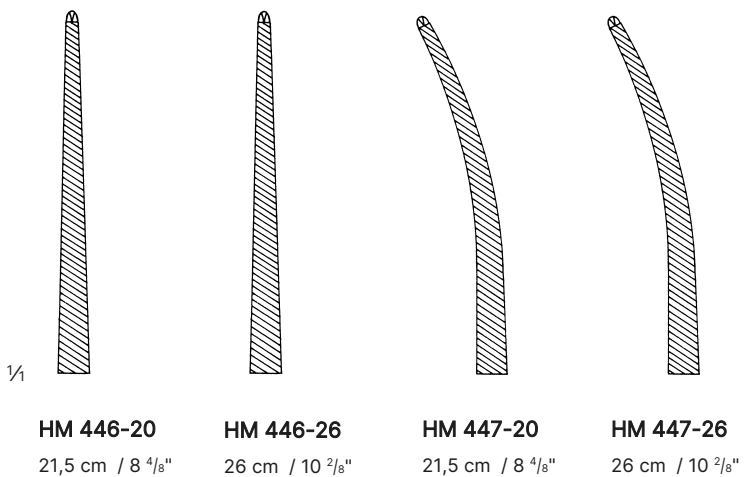

1/4

HM 446-20

21,5 cm / 8 4/8"

HM 446-26

26 cm / 10 2/8"

HM 447-20

21,5 cm / 8 4/8"

HM 447-26

26 cm / 10 2/8"



1/2

Heiss

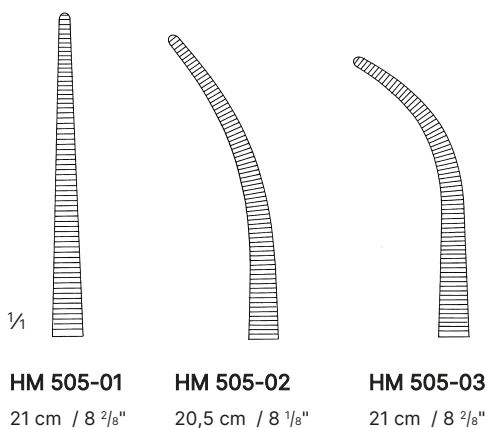

1/4

HM 505-01

21 cm / 8 2/8"

HM 505-02

20,5 cm / 8 1/8"

HM 505-03

21 cm / 8 2/8"

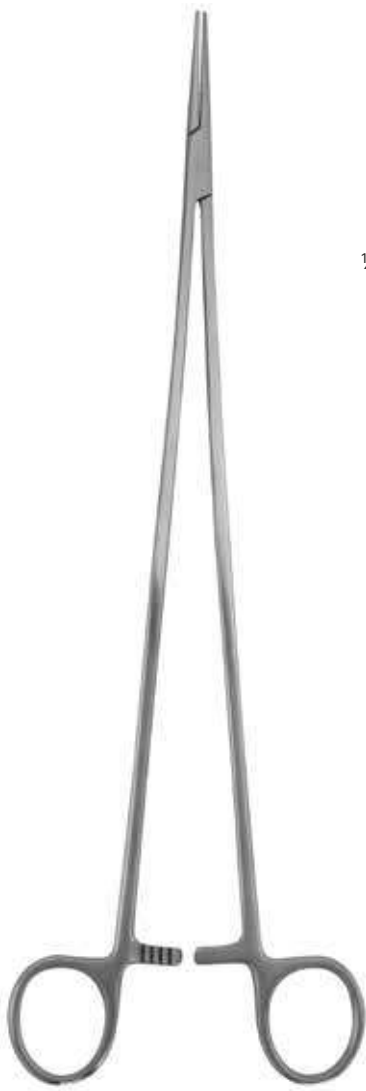

1/2

Bridge

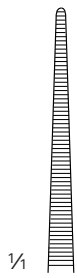

1/4

HM 526-28
28 cm / 11"

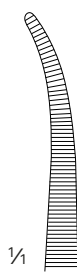

1/4

HM 527-28
28 cm / 11"



1/2

Crafoord
HM 510-24
24,5 cm / 9 5/8"

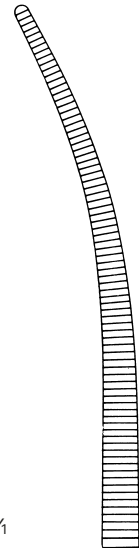

1/4



Clamps

Hemostatic Clamps



1/2

Spencer-Wells

1/4



HM 430-13
13 cm / 5 1/8"



HM 430-14
14,5 cm / 5 6/8"



HM 430-15
15,5 cm / 6 1/8"



HM 430-18
18,5 cm / 7 2/8"



HM 430-20
20 cm / 7 7/8"

1/4



HM 431-13
13 cm / 5 1/8"



HM 431-14
14 cm / 5 4/8"



HM 431-15
15 cm / 5 7/8"



HM 431-18
18 cm / 7 1/8"

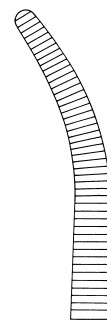

HM 431-20
20 cm / 7 7/8"



1/2

Pean

| | | | | | |
|--------------------------------------|--------------------------------------|------------------------------------|------------------------------------|------------------------------------|--------------------------------------|
| | | | | | |
| 1/4 | | | | | |
| HM 427-13 13,5 cm / 5 3/8" | HM 427-14 14,5 cm / 5 9/8" | HM 427-16 17 cm / 6 8/8" | HM 428-13 13 cm / 5 1/8" | HM 428-14 14 cm / 5 4/8" | HM 428-16 16,5 cm / 6 4/8" |



1/2

Kocher

| | | | | | |
|------------------------------------|------------------------------------|------------------------------------|------------------------------------|------------------------------------|------------------------------------|
| | | | | | |
| 1x2 | 1/4 | | | | |
| HM 429-13 13 cm / 5 1/8" | HM 429-14 14 cm / 5 4/8" | HM 429-16 16 cm / 6 2/8" | HM 432-13 13 cm / 5 1/8" | HM 432-14 14 cm / 5 4/8" | HM 432-16 16 cm / 6 2/8" |



Clamps

Hemostatic Clamps

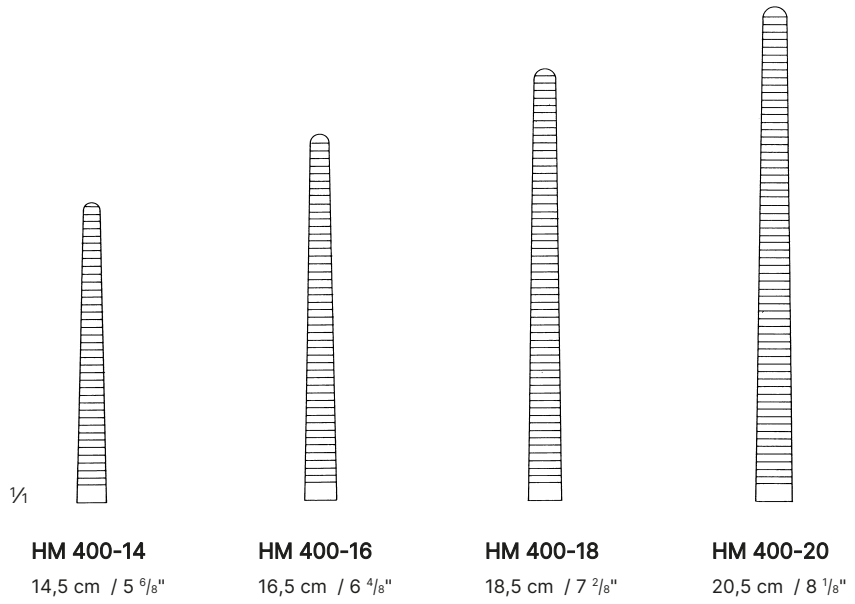

$\frac{1}{2}$

Pean -Rochester

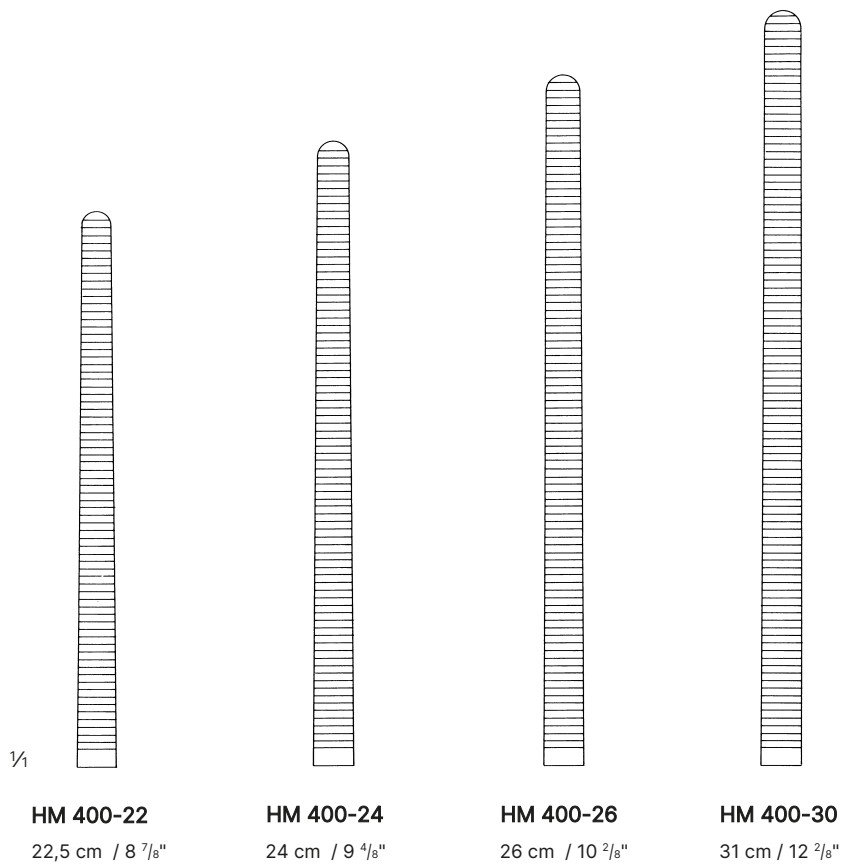

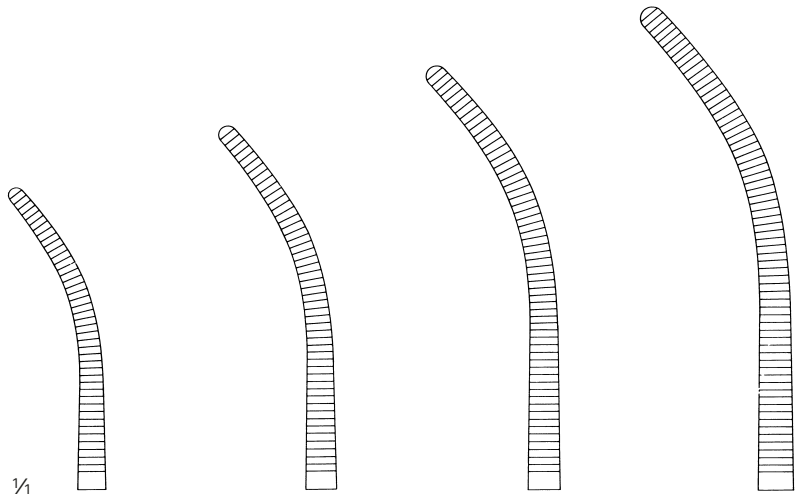

1/1

HM 401-14
14 cm / 5 4/8"

HM 401-16
16,5 cm / 6 4/8"

HM 401-18
18,5 cm / 7 2/8"

HM 401-20
20,5 cm / 8 1/8"



1/2

Pean -Rochester

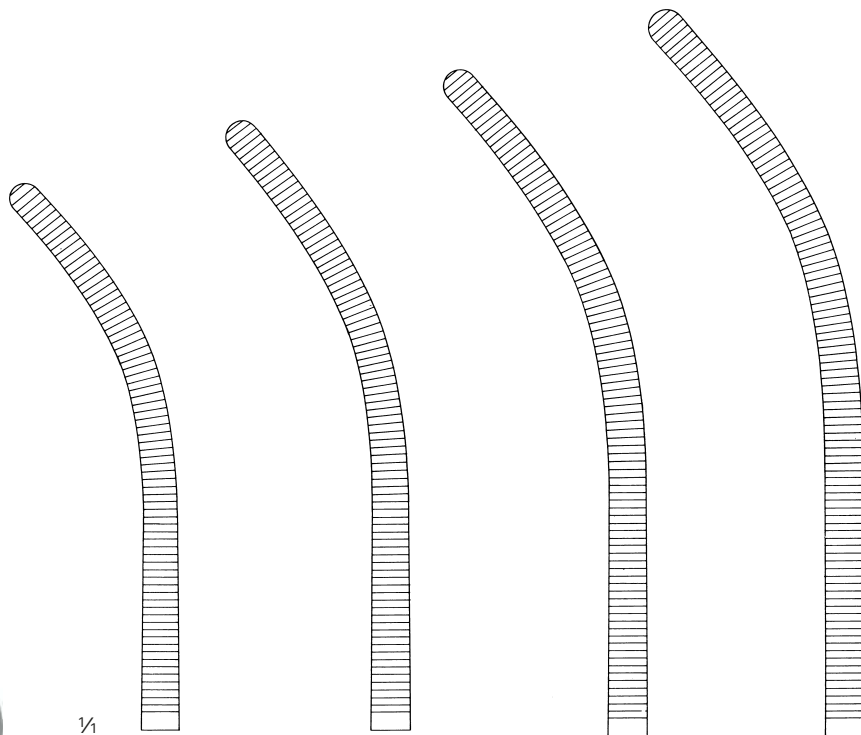

1/1

HM 401-22
22 cm / 8 5/8"

HM 401-24
24 cm / 9 4/8"

HM 401-26
26 cm / 10 2/8"

HM 401-30
30,5 cm / 12"



Clamps
Hemostatic Clamps

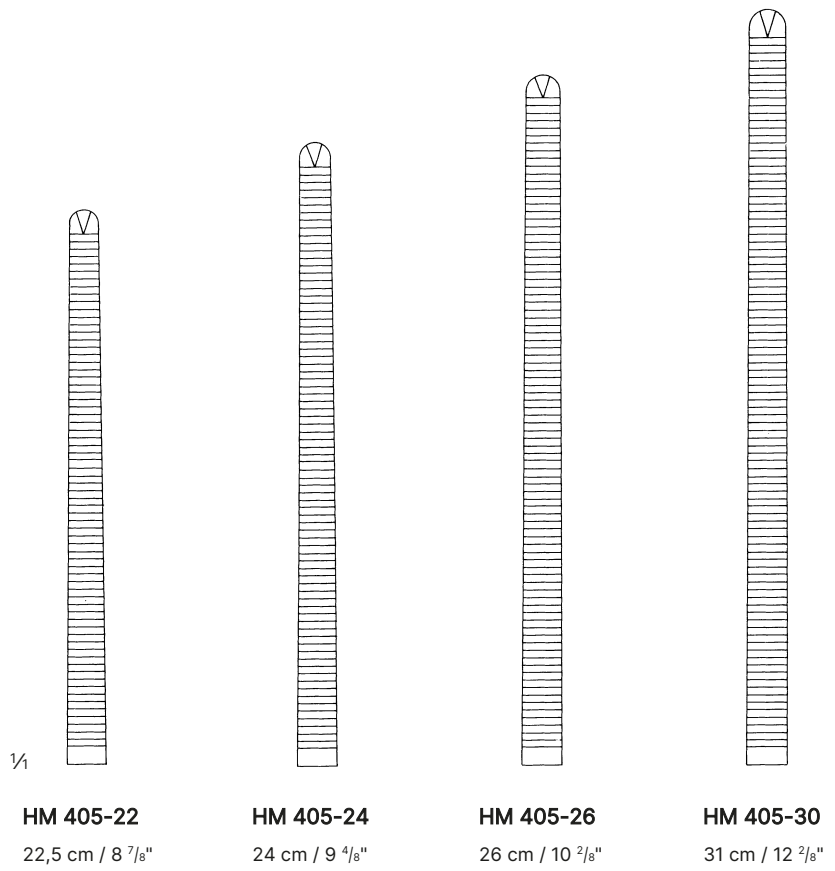
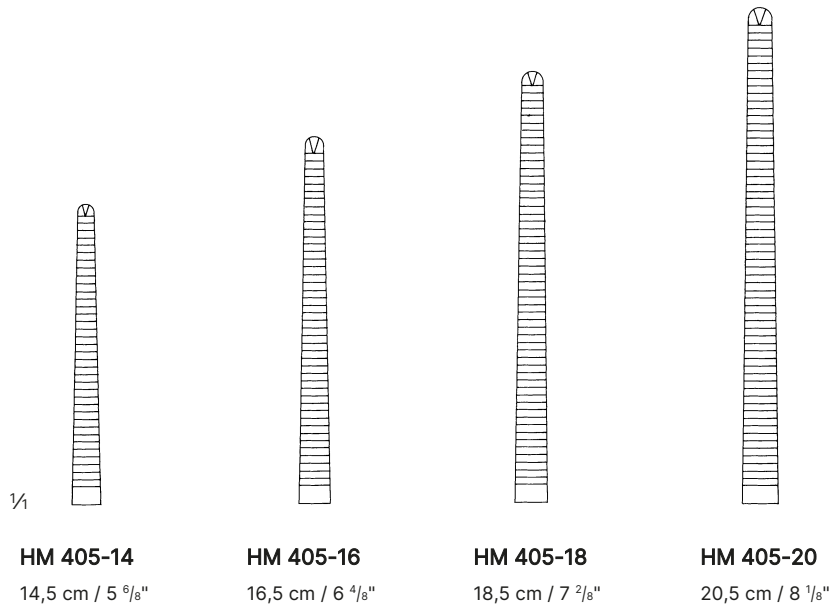

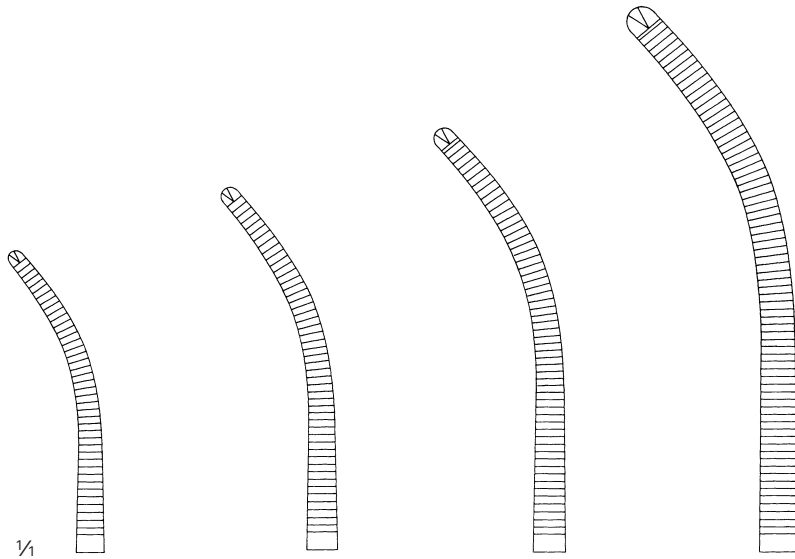

1/4

HM 406-14
14 cm / 5 4/8"

HM 406-16
16,5 cm / 6 4/8"

HM 406-18
18,5 cm / 7 2/8"

HM 406-20
20 cm / 7 7/8"



1x2

1/2

Kocher -Ochsner

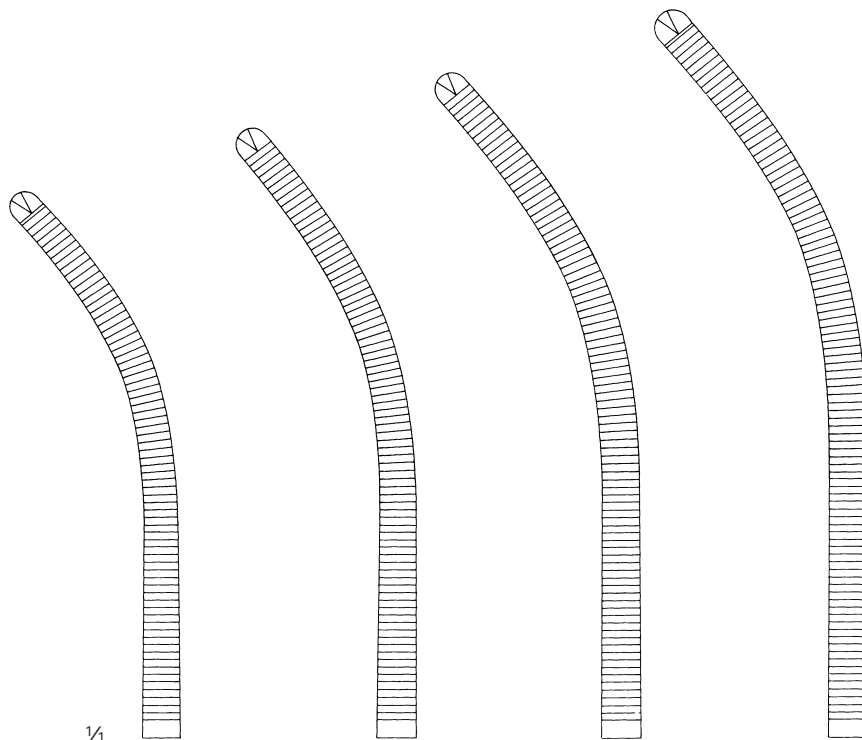

1/4

HM 406-22
22,5 cm / 8 7/8"

HM 406-24
24 cm / 9 4/8"

HM 406-26
26 cm / 10 2/8"

HM 406-30
30,5 cm / 12"



Clamps

Hemostatic Clamps, Dissecting and Ligature Clamps



1/2

Rochester-Carmalt

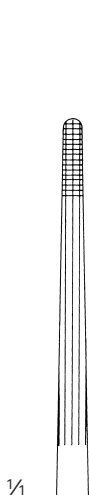

1/4

HM 440-16
17 cm / 6 5/8"



HM 440-20
20,5 cm / 8 1/8"



HM 441-16
16,5 cm / 6 4/8"

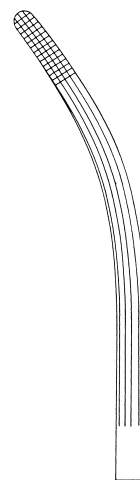

HM 441-20
20 cm / 7 7/8"



1/2

Roberts

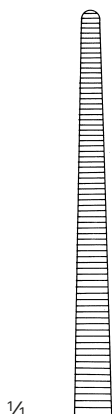

1/4

HM 506-22
22,5 cm / 8 7/8"

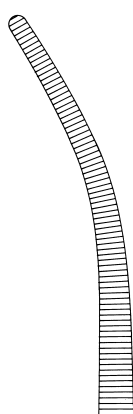

HM 507-23
22 cm / 8 5/8"



1/2

Sarot



1/4

HM 508-24
25 cm / 9 7/8"

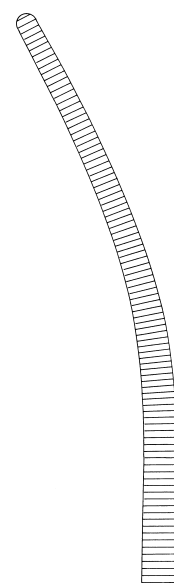

HM 509-24
24,5 cm / 9 5/8"



1/2

Moynihan

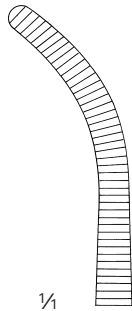

1/1

HM 583-23
23 cm / 9"

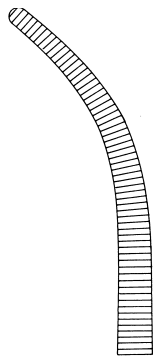

HM 584-24
23,5 cm / 9 2/8"



1/2

Guyon

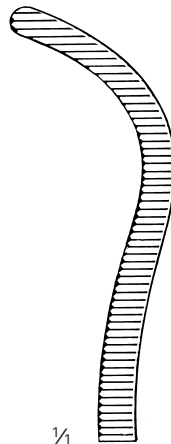

1/1

HM 543-20
19,5 cm / 7 5/8"

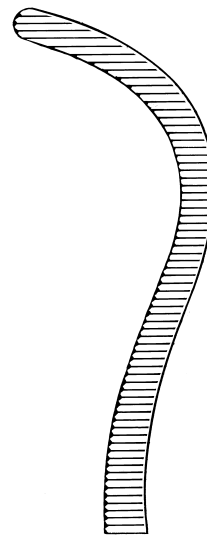

HM 543-22
21,5 cm / 8 4/8"

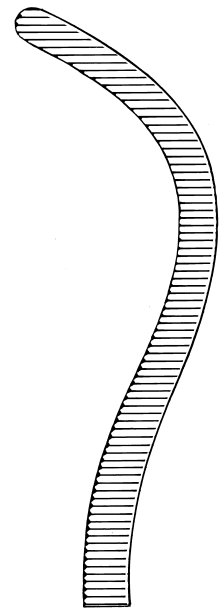

HM 543-24
24,5 cm / 9 5/8"



Clamps

Dissecting and Ligature Clamps



Baby-Adson

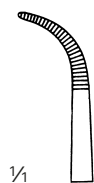

HM 415-14
14,5 cm / 5 ⁶/₈"

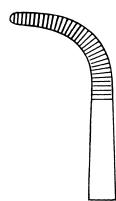

HM 415-18
18 cm / 7 ¹/₈"



Mixer-Baby

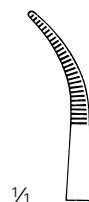

HM 520-01
13,5 cm / 5 ³/₈"

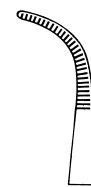

HM 520-02
13 cm / 5 ¹/₈"



Mixer-Baby
HM 522-18
18,5 cm / 7 ²/₈"

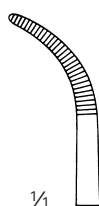

Overholt-Baby
HM 424-13
13,5 cm / 5 ³/₈"

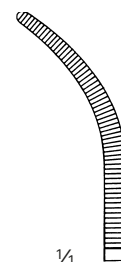



1/2

Gemini

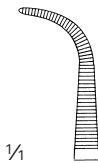

1/4

HM 532-14
13 cm / 5 1/8"

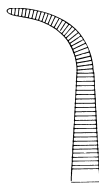

HM 532-16
16 cm / 6 2/8"

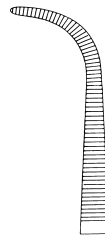

HM 532-18
18 cm / 7 1/8"

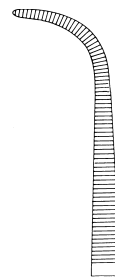

HM 532-20
21 cm / 8 2/8"

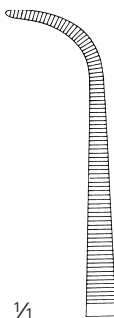

1/4

HM 532-23
23 cm / 9"

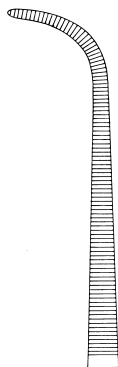

HM 532-25
25 cm / 9 7/8"



HM 532-28
28 cm / 11"



1/2

Overholt

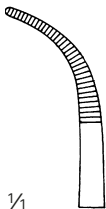

1/4

Fig.1
HM 426-18
18,5 cm / 7 2/8"

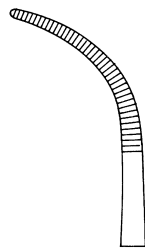

Fig.2
HM 426-20
20,5 cm / 8 1/8"

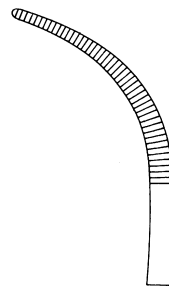

Fig.3
HM 426-21
21cm / 8 2/8"

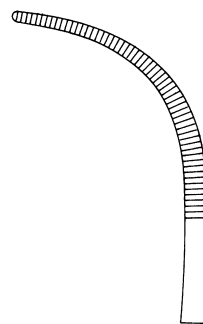

Fig.4
HM 426-22
21,5 cm / 8 2/8"



Clamps

Dissecting and Ligature Clamps



1/2

Overholt-Geissendoerfer

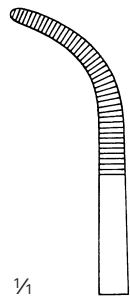

1/1

Fig. 1

HM 420-01

20,5 cm / 8 1/8"

HM 421-01

27 cm / 10 5/8"

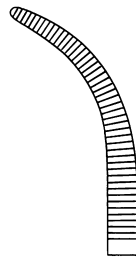

Fig.2

HM 420-02

20 cm / 7 7/8"

HM 421-02

26,5 cm / 10 3/8"

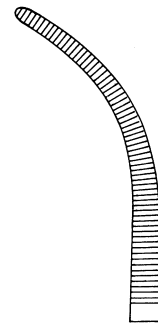

Fig.3

HM 420-03

21,5 cm / 8 4/8"

HM 421-03

27,5 cm / 10 7/8"

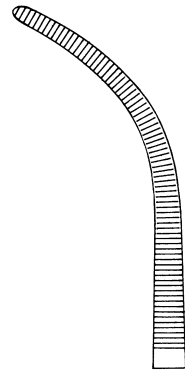

Fig.4

HM 420-04

22 cm / 8 5/8"

HM 421-04

28 cm / 11"

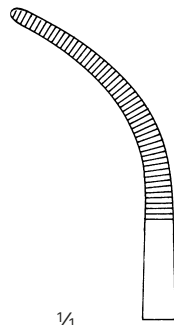

1/1

Fig. 5

HM 420-05

21,5 cm / 8 4/8"

HM 421-05

27,5 cm / 10 7/8"

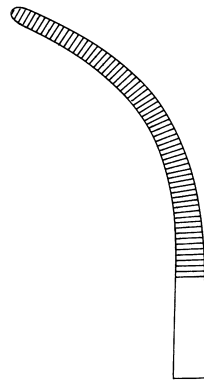

Fig.6

HM 420-06

21,5 cm / 8 2/8"

HM 421-06

28 cm / 11"



Fig.7

HM 420-07

22 cm / 8 5/8"

HM 421-07

27,5 cm / 10 7/8"



1/2

O'Shaughnessy

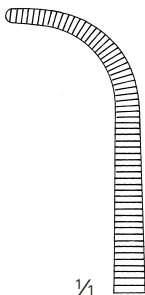

1/4

HM 521-15
15 cm / 5 7/8"

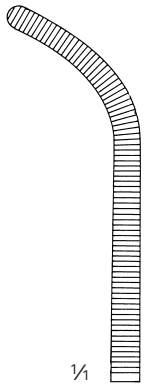

1/4

HM 521-19
18,5 cm / 7 2/8"

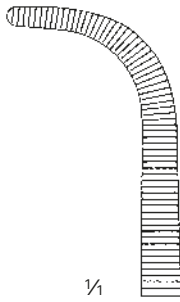

1/4

HM 520-22
22 cm / 8 5/8"



1/2

Mixer

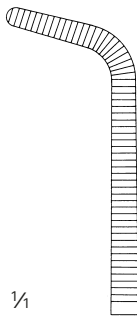

1/4

HM 520-15
16 cm / 6 2/8"

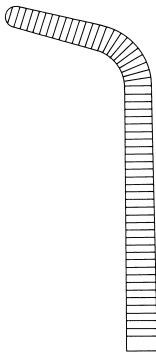

HM 520-19
17,5 cm / 6 7/8"



1/2

Mixer
HM 525-23
23 cm / 9"

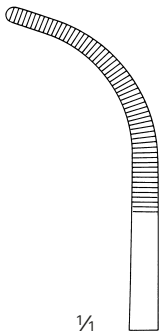

1/4

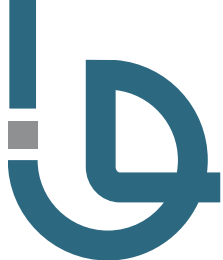

Clamps

Dissecting and Ligature Clamps

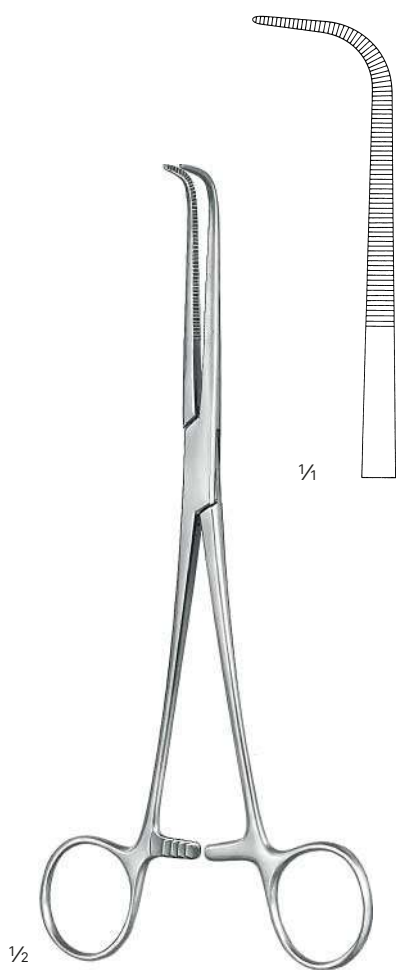

1/2

Wikstroem

HM 552-19

21 cm / 8 2/8"



1/2

Kantrowitz



HM 530-20

20 cm / 7 7/8"



HM 530-24

24 cm / 7 7/8"



HM 530-28

28 cm / 7 7/8"

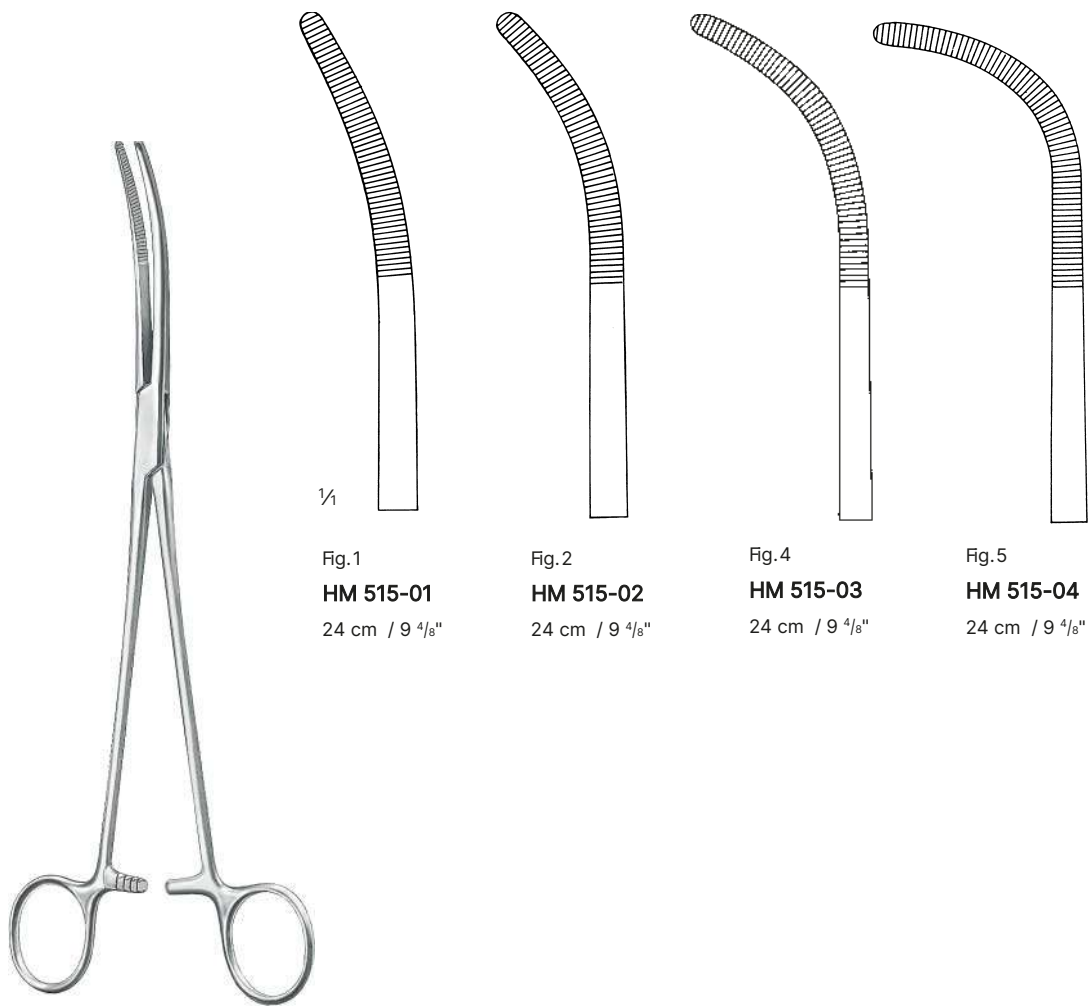

Fig.1
HM 515-01
24 cm / 9 $\frac{4}{8}$ "

Fig.2
HM 515-02
24 cm / 9 $\frac{4}{8}$ "

Fig.4
HM 515-03
24 cm / 9 $\frac{4}{8}$ "

Fig.5
HM 515-04
24 cm / 9 $\frac{4}{8}$ "

Rumel



Clamps

Dissecting and Ligature Clamps



Meeker

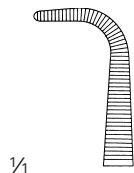

1/4

HM 420-18

18 cm / 7"

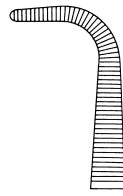

HM 420-28

28 cm / 11"



1/2

Lawrence

HM 531-28

28 cm / 11"

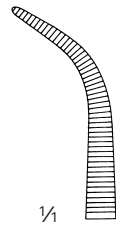

1/4



1/2

Zenker

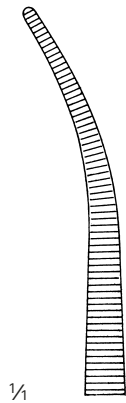

1/4

HM 516-29

29,5 cm / 11 5/8"

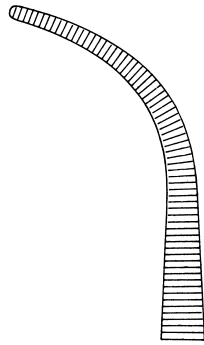

HM 517-29

28,5 cm / 11 2/8"



1/2

Mixer

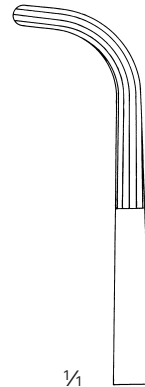

1/4

HM 521-22

22,5 cm / 8 6/8"



HM 521-25

26 cm / 10 2/8"

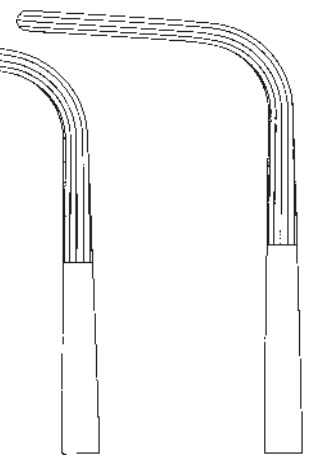

HM 521-28

28 cm / 11"

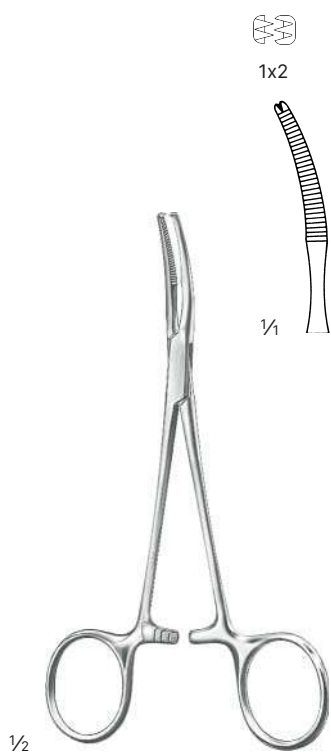
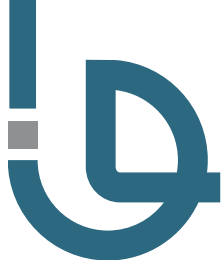

Mikulicz-Baby
HM 700-14
14,5 cm / 5 7/8"

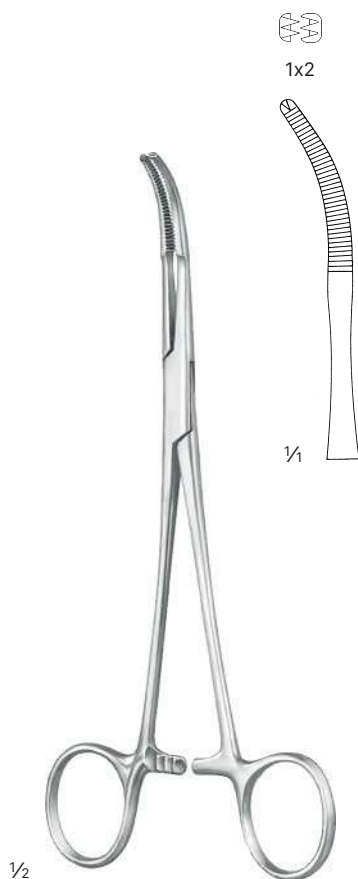

Mikulicz
HM 701-18
18,5 cm / 7 2/8"

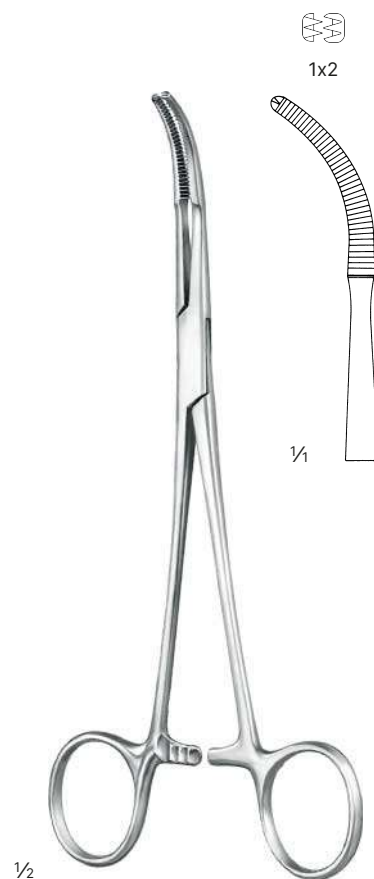

Mikulicz
HM 702-20
20 cm / 7 7/8"

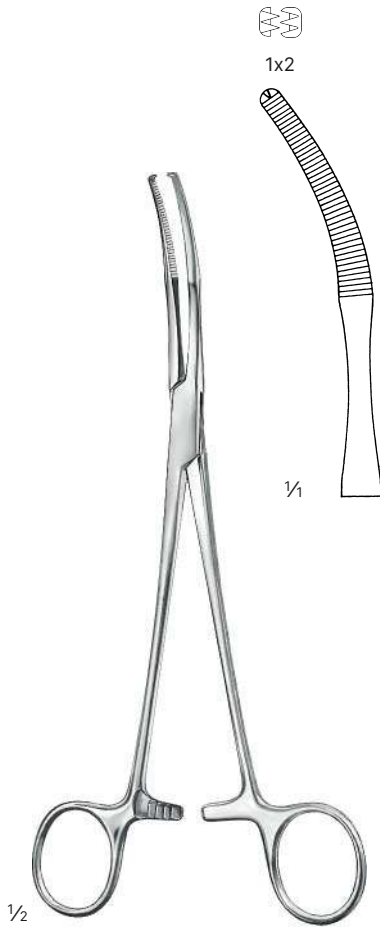

Mikulicz
HM 703-20
20 cm / 7 7/8"

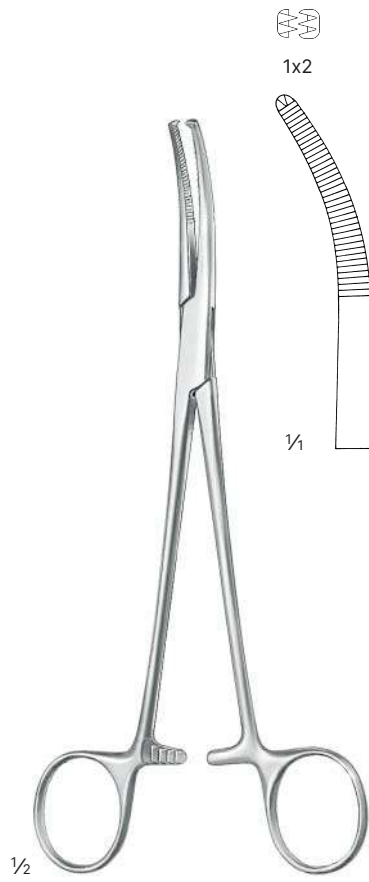

Mikulicz
HM 704-20
20,5 cm / 8 1/8"

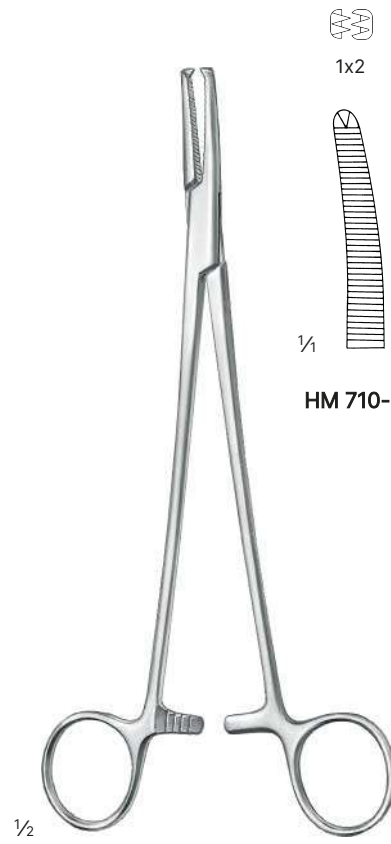

Faure
21 cm / 8 2/8"

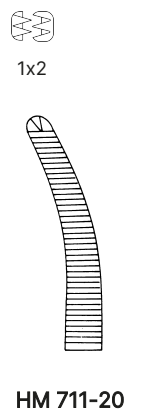

HM 711-20



Clamps
Hysterectomy Clamps

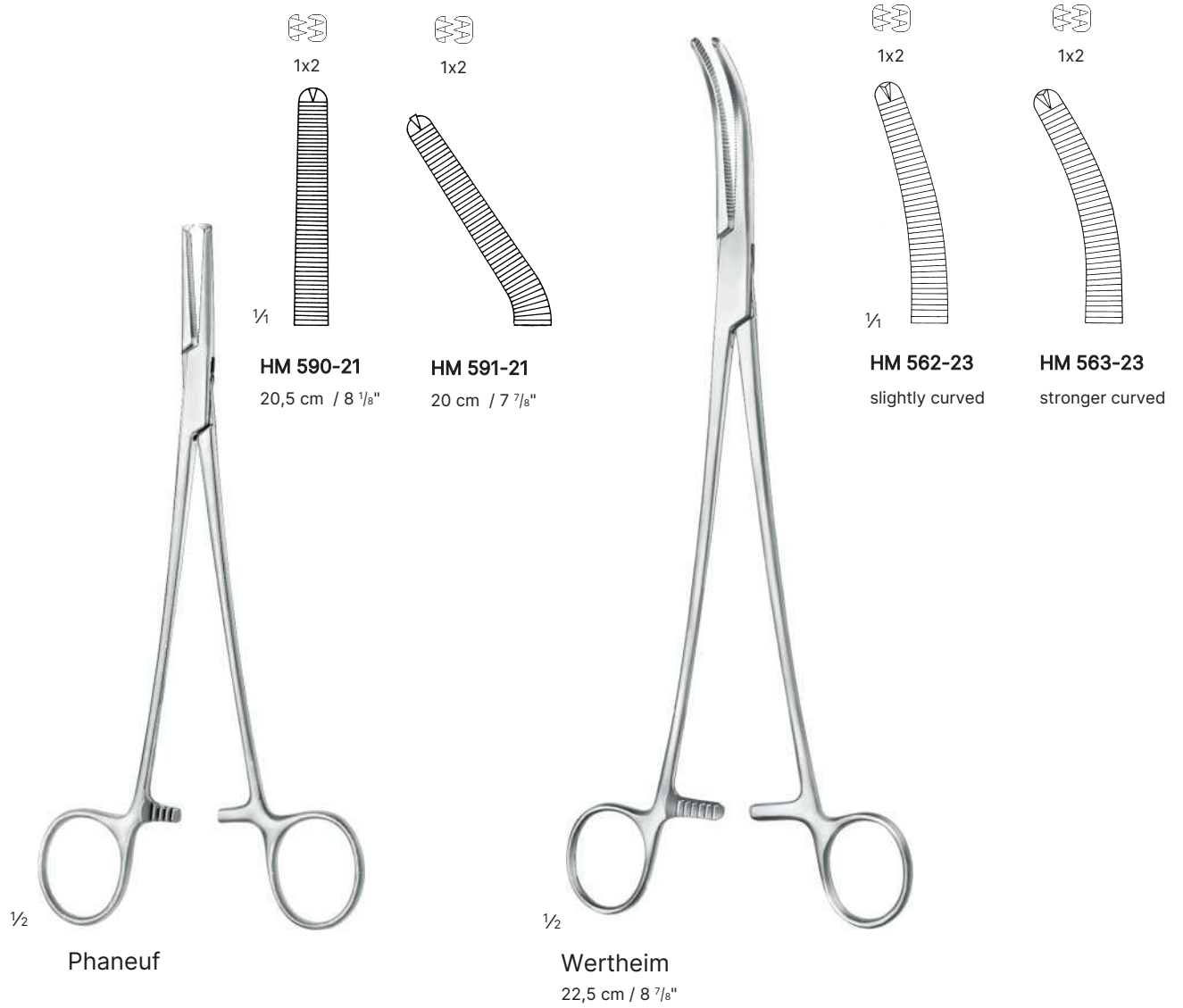

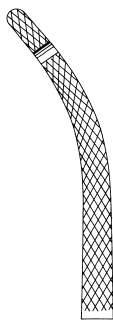

Fig.1
HM 571-19
19,5 cm / 7 ⁵/₈"

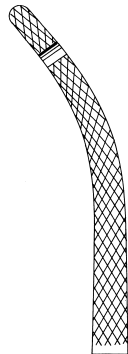

Fig.1
HM 571-21
21,5 cm / 8 ⁴/₈"

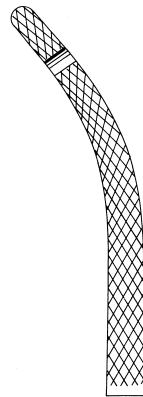
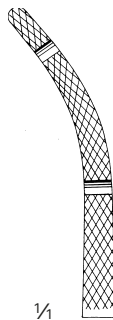

Fig.1
HM 571-23
24 cm / 9 ⁴/₈"



1/1
Fig.2
HM 572-19
19,5 cm / 7 ⁵/₈"

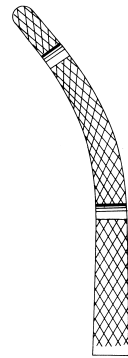

Fig.2
HM 572-21
21,5 cm / 8 ⁴/₈"

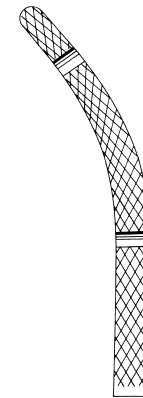

Fig.2
HM 572-23
24 cm / 9 ⁴/₈"



1/2

Heaney



Atraumatic

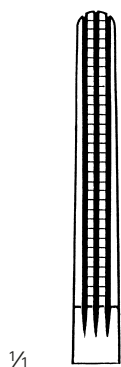

1/1

Fig.1
HM 600-00
21,5 cm / 8 4/8"

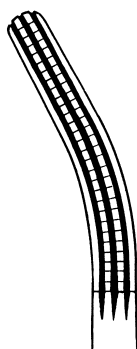

Fig.2
HM 600-01
21 cm / 8 2/8"

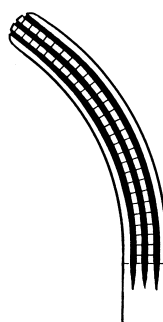

Fig.3
HM 600-02
21 cm / 8 2/8"

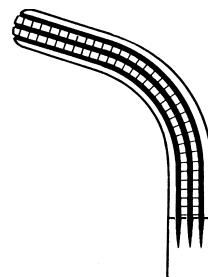
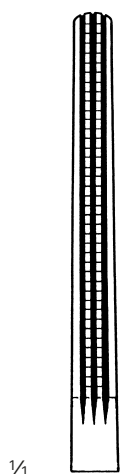

Fig.4
HM 600-03
20,5 cm / 8 1/8"



1/1

Fig.1
HM 601-00
25,5 cm / 10"

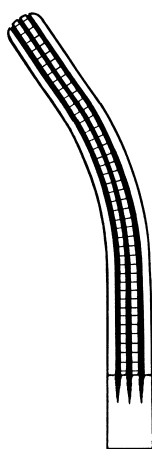

Fig.2
HM 601-01
25 cm / 9 7/8"

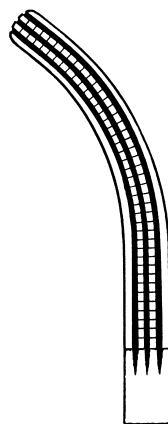

Fig.3
HM 601-02
24,5 cm / 9 4/8"

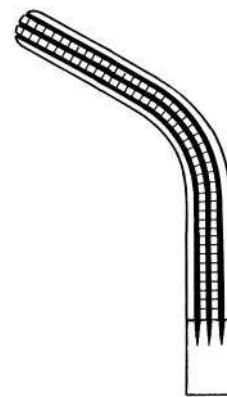
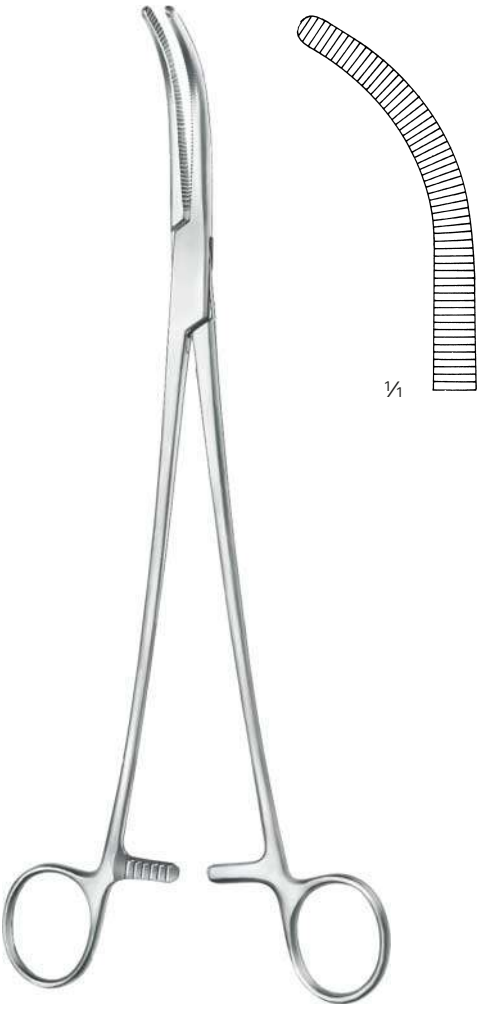

Fig.4
HM 601-03
24,5 cm / 9 4/8"



1/2

Rogers



1/2

Wertheim
HM 561-25
26 cm / 10 2/8"

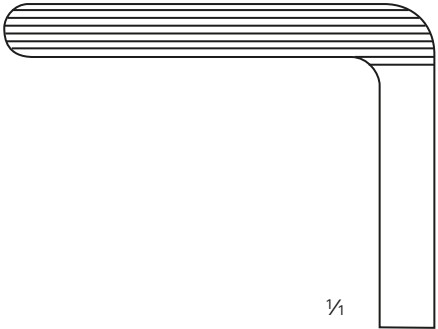

1/4



1/2

Wertheim-Cullen
HM 585-21
21 cm / 8 2/8"

Needle Holders and Suture Instruments

Micro Needle Holders

Needle Holders

Ligature Needles

Clip Applying and Removing Forceps



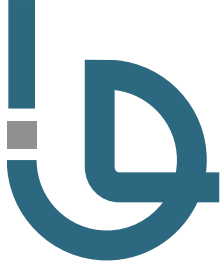

Needle Holders and Suture Instruments

Micro Needle Holders

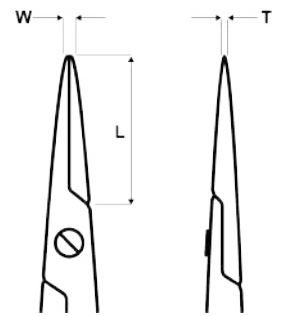

Length x Thickness x Width



1/1

Barraquer-Troutman

12 cm / 4 3/4"



9-0 and smaller

10 x 0,75 x 1,0 mm

1/1



without ratchet

PO 100-10

PO 101-10

with ratchet

PO 102-10

PO 103-10

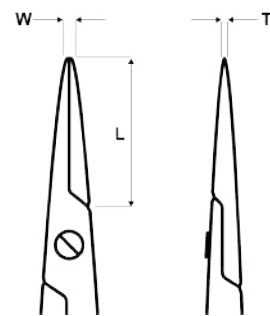

Length x Thickness x Width



With ratchet



9-0 and smaller

12 x 0,8 x 1,2 mm

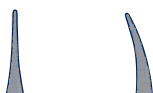

0,3



7-0 and smaller

13 x 1,3 x 2,0 mm



- 14,5 cm / 5 7/8"
- 18 cm / 7 1/8"
- 21 cm / 8 2/8"
- 23 cm / 9"

- PO 105-14
- PO 110-15
- PO 117-18

- PO 106-14
- PO 111-15
- PO 118-18

- PO 966-01
- PO 968-01
- PO 970-01
- PO 970-03

- PO 966-02
- PO 968-02
- PO 970-02
- PO 970-04



Needle Holders and Suture Instruments

Micro Needle Holders

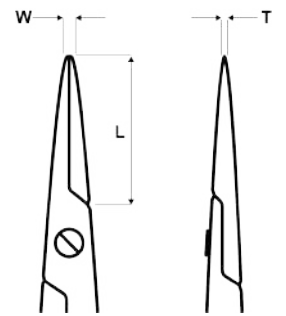

Length x Thickness x Width

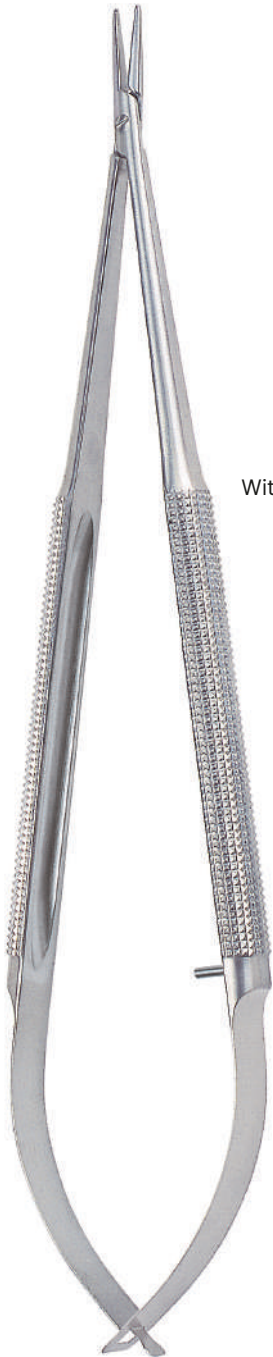

Without ratchet



9-0 and smaller

12 x 0,8 x 1,2 mm

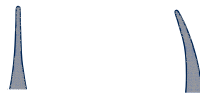

14,5 cm / 5 6/8"

PO 104-13

PO 104-14

18 cm / 7 1/8"

PO 108-15

PO 109-15

21 cm / 8 2/8"

PO 115-18

PO 116-18



0,3



7-0 and smaller

13 x 1,3 x 2,0 mm



PO 965-01

PO 965-02

PO 967-01

PO 967-02

PO 969-01

PO 969-02



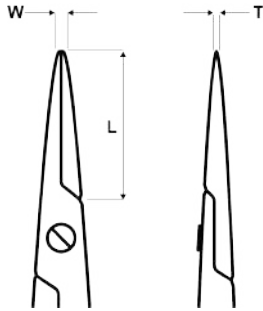

With ratchet



Length x Thickness x Width

 **TC**

-  0,3
-  6-0 and smaller
- 17 x 2,0 x 3,0
-  1/1

18 cm / 7 1/8"
23 cm / 9"

PO 921-18
PO 921-23

1/4

Heavy Pattern



Needle Holders and Suture Instruments

Micro Needle Holders

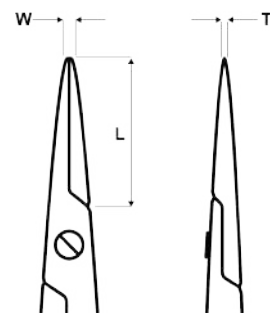

Length x Thickness x Width



7-0 and smaller

12 x 1,2 x 1,6 mm



with ratched

without ratched

with ratched

without ratched

14 cm / 5 1/2"

PO 121-09

PO 119-09

PO 122-09

PO 120-09

18 cm / 7 1/8"

PO 127-14

PO 123-14

PO 128-14

PO 124-14

21 cm / 8 2/8"

PO 132-16

PO 131-16

PO 132-18

PO 131-18



TC



0,3



6-0 and smaller

13 x 1,6 x 2,3 mm



with ratched

without ratched

with ratched

without ratched

14 cm / 5 1/2"

PO 952-14

PO 950-14

PO 953-14

PO 951-14

18 cm / 7 1/8"

PO 956-18

PO 954-18

PO 957-18

PO 955-18

21 cm / 8 2/8"

PO 959-01

PO 958-01

PO 959-02

PO 958-02

23 cm / 9"

PO 959-03

PO 959-04



1/4

Castroviejo



Derf
PO 210-12
12 cm / 4 6/8"

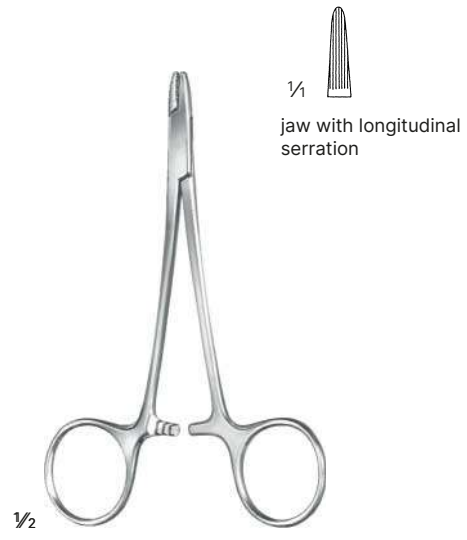

Converse
PO 211-12
12,5 cm / 4 7/8"

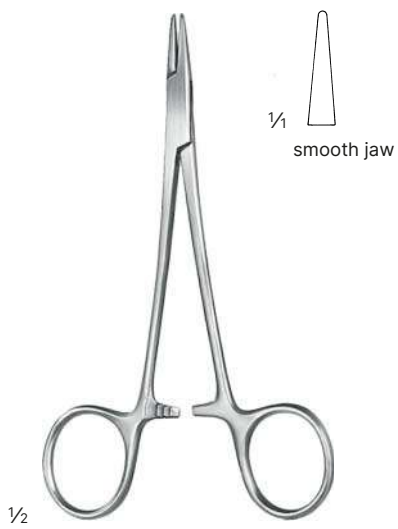

Webster
PO 214-13
13 cm / 5 1/8"



Halsey
PO 216-13
13 cm / 5 1/8"

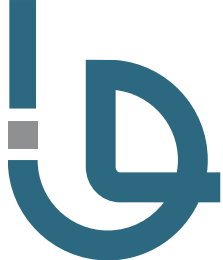

Needle Holders and Suture Instruments

Needle Holders



Crile-Wood

PO 219-15

15 cm / 5 7/8"



Crile-Murray

PO 220-15

15 cm / 5 7/8"
slender pattern



Mayo-Hegar

1/1



PO 230-14
14 cm / 5 4/8"



PO 230-16
16 cm / 6 2/8"



PO 230-18
18 cm / 7 1/8"



PO 230-20
20 cm / 7 7/8"

1/1



PO 230-24
24 cm / 9 3/8"



PO 230-26
26 cm / 10 2/8"



PO 230-30
30 cm / 11 7/8"



Mayo-Hegar
slender pattern

1/1



PO 231-16
16 cm / 6 2/8"



PO 231-18
18 cm / 7 1/8"

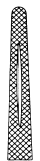

PO 231-20
20 cm / 7 7/8"

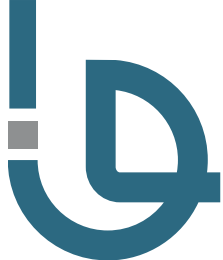

Needle Holders and Suture Instruments

Needle Holders



1/2

Heaney
PO 232-21
20 cm / 8 4/8"



1/2

Jameson
PO 233-23
23 cm / 9"



1/2

Masson
PO 234-27
27 cm / 10 6/8"
heavy pattern

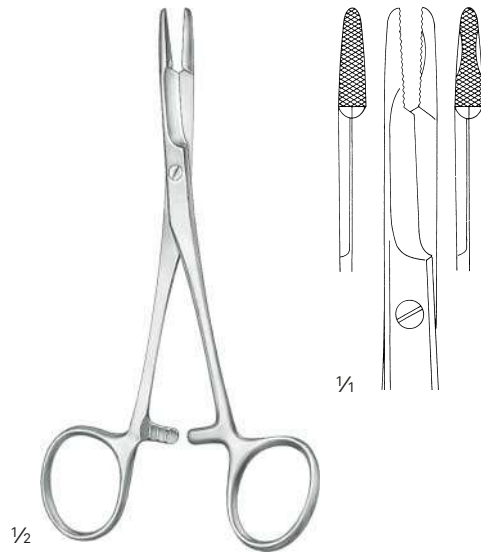

Olsen-Hegar

PO 239-14

14 cm / 5 ⁴/₈"

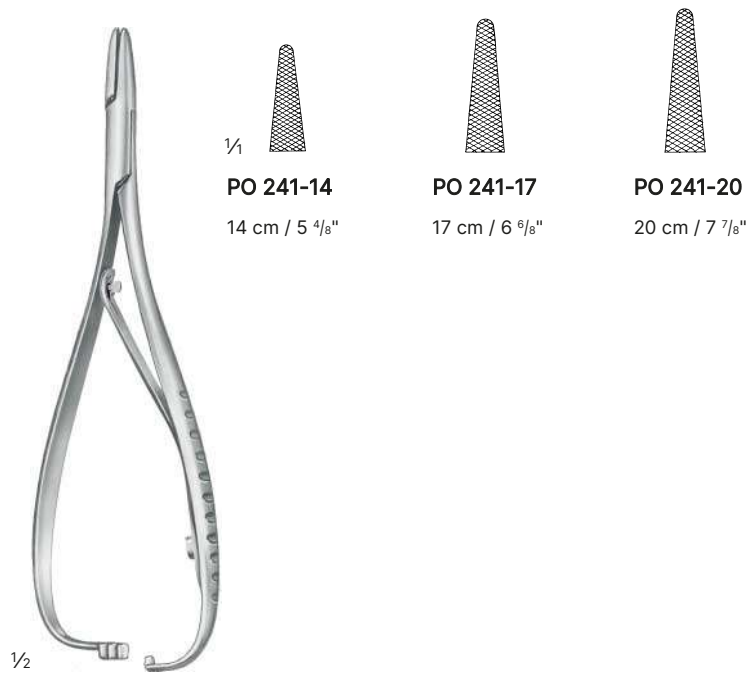

Mathieu

1/4

PO 241-14

14 cm / 5 ⁴/₈"

PO 241-17

17 cm / 6 ⁶/₈"

PO 241-20

20 cm / 7 ⁷/₈"

1/2

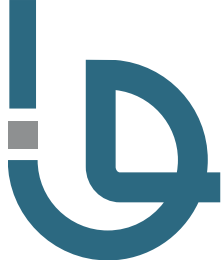

Needle Holders and Suture Instruments

Needle Holders

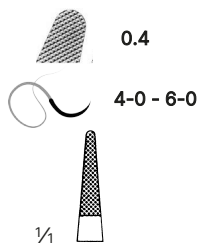

Derf
PO 910-12
12,5 cm / 4 7/8"

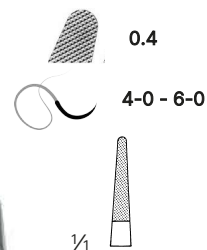

Converse
PO 911-12
12,5 cm / 4 7/8"

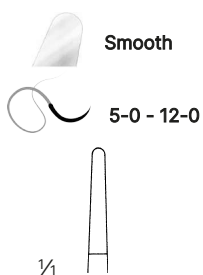

Halsey

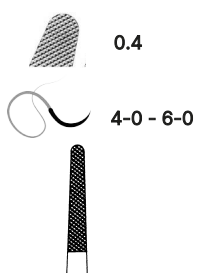

PO 916-13
13 cm / 5 1/8"

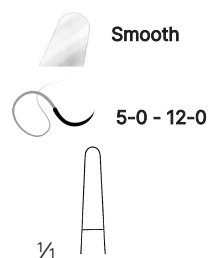

Webster
PO 914-13
13 cm / 5 1/8"



Hegar-Baumgartner
PO 916-14
 14 cm / 5 5/8"

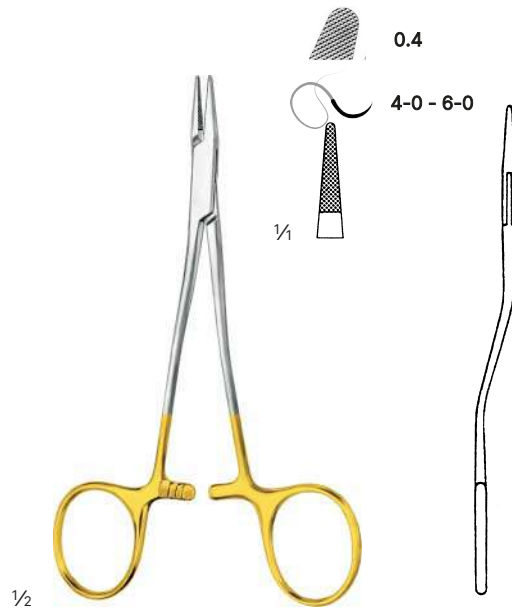
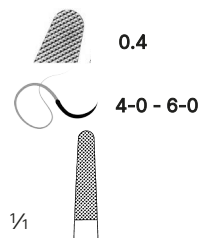

Kilner
PO 912-13
 13,5 cm / 5 3/8"

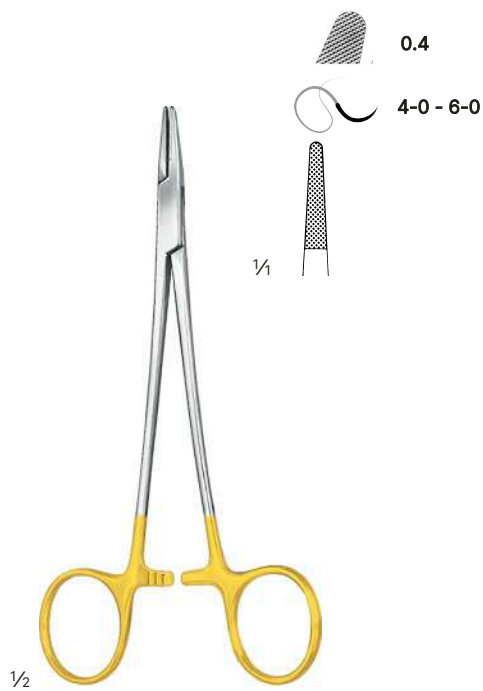
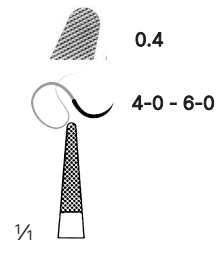

Crile-Wood
PO 919-15
 15 cm / 5 7/8"

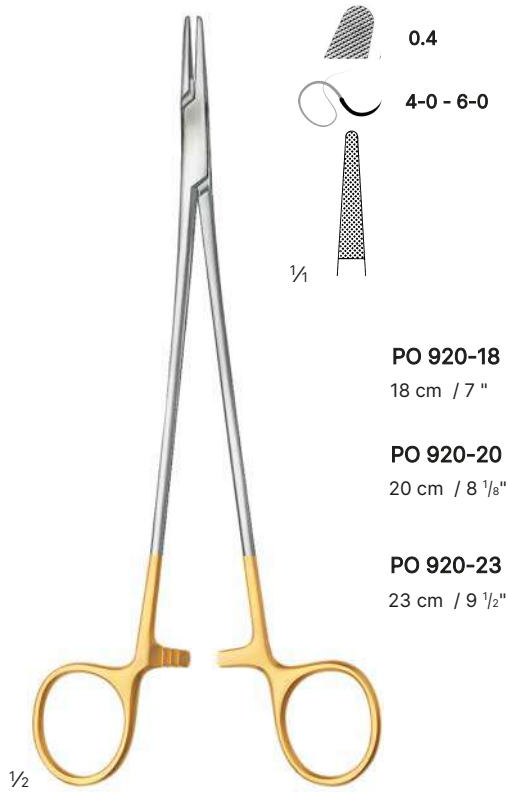
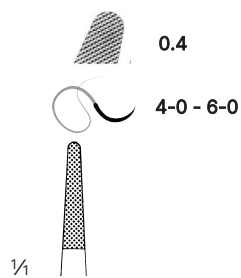

Crile-Wood

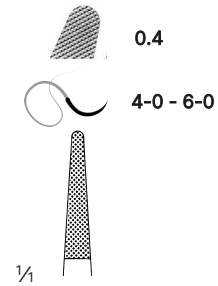

PO 920-18
 18 cm / 7 "

PO 920-20
 20 cm / 8 1/8"

PO 920-23
 23 cm / 9 1/2"



Needle Holders and Suture Instruments

Needle Holders



4-0 and smaller



PO 900-16
16 cm / 6 2/8"

PO 900-18
18 cm / 7 1/8"

PO 900-20
20 cm / 7 7/8"



PO 900-24
24 cm / 9 4/8"

PO 900-26
26 cm / 10 2/8"

PO 900-30
30 cm / 11 6/8"



1/2

Mayo-Hegar

6-0 and smaller

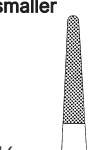

PO 901-15
15 cm / 6"

PO 901-18
18 cm / 7 1/8"

PO 901-20
20,5 cm / 8 1/8"



PO 901-23
23 cm / 9"

PO 901-26
26,5 cm / 10 3/8"

PO 901-31
31 cm / 12 2/8"



1/2

DeBakey

TC



1/2

Ryder

6-0 and smaller
 0.4

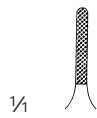

PO 902-13
13 cm / 5 1/8"

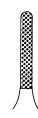

PO 902-15
15 cm / 5 7/8"



PO 902-18
18 cm / 7 1/8"

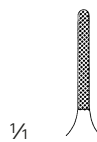

PO 902-20
20 cm / 7 7/8"



PO 902-23
23 cm / 9"



PO 902-26
26 cm / 10 2/8"



1/2

Micro Ryder
delicate pattern

5-0 - 7-0
 0.3

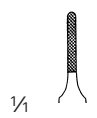

PO 903-13
13 cm / 5 1/8"



PO 903-15
15 cm / 5 7/8"



PO 903-18
18 cm / 7 1/8"

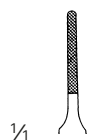

PO 903-20
20 cm / 7 7/8"



PO 903-23
23 cm / 9 2/8"

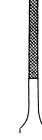

PO 903-26
26 cm / 10 2/8"



Needle Holders and Suture Instruments

Needle Holders

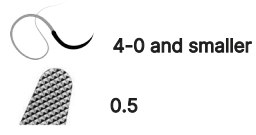

Stratte
PO 970-23
23 cm / 9"

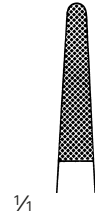
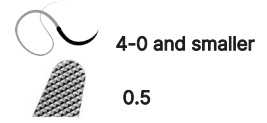

Wangenstein
PO 981-27
27 cm / 10 5/8"

 TC



1/2

Olsen Hegar
standard profile

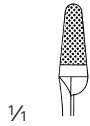
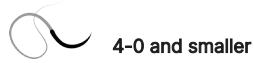

PO 924-14
14 cm / 5 4/8"



PO 924-17
17 cm / 6 6/8"



PO 924-19
19 cm / 7 4/8"



PO 926-14
14 cm / 5 4/8"



PO 926-17
17 cm / 6 6/8"



PO 926-20
20 cm / 7 7/8"



1/2

Mathieu

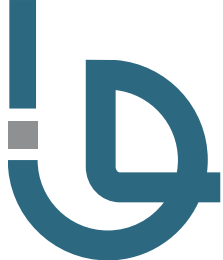

Needle Holders and Suture Instruments

Ligature Needles

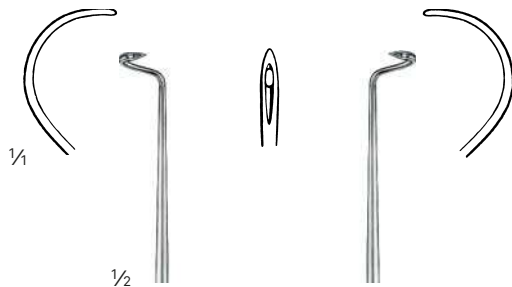

PO 160-20
20 cm / 7 7/8"
sharp, for right hand

PO 161-20
20 cm / 7 7/8"
sharp, for left hand

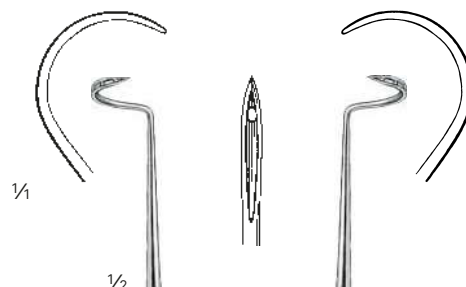

PO 162-20
20 cm / 7 7/8"
sharp, for right hand

PO 163-20
20 cm / 7 7/8"
sharp, for left hand



1/2

Deschamps

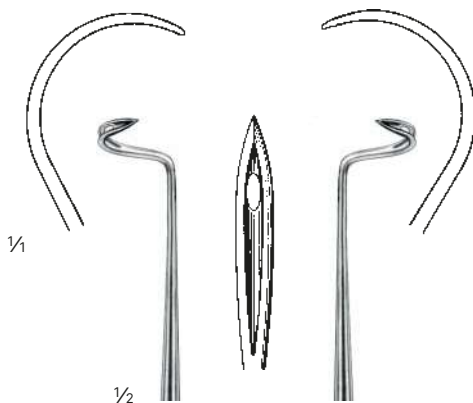

PO 164-21
21 cm / 8 2/8"
sharp, for right hand

PO 165-21
21 cm / 8 2/8"
sharp, for left hand

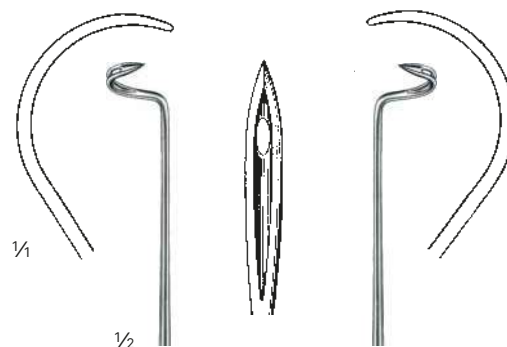

PO 164-27
27 cm / 10 5/8"
sharp, for right hand

PO 165-27
27 cm / 10 5/8"
sharp, for left hand

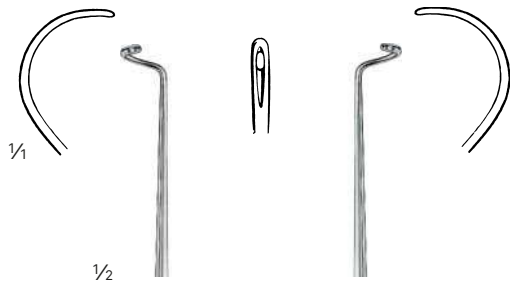

PO 166-20
20 cm / 7 ⁷/₈"
blunt, for right hand

PO 167-20
20 cm / 7 ⁷/₈"
blunt, for left hand

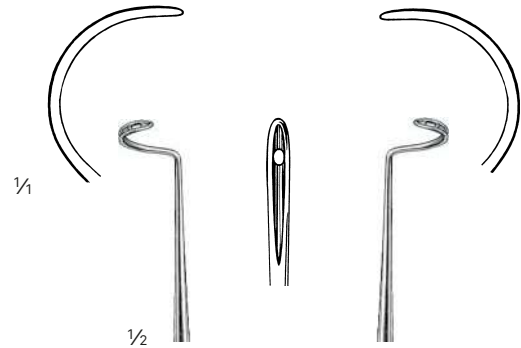

PO 168-20
20 cm / 7 ⁷/₈"
blunt, for right hand

PO 169-20
20 cm / 7 ⁷/₈"
blunt, for left hand

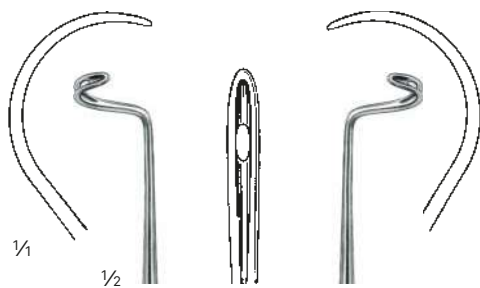

PO 170-21
21 cm / 8 ²/₈"
blunt, for right hand

PO 171-21
21 cm / 8 ²/₈"
blunt, for left hand

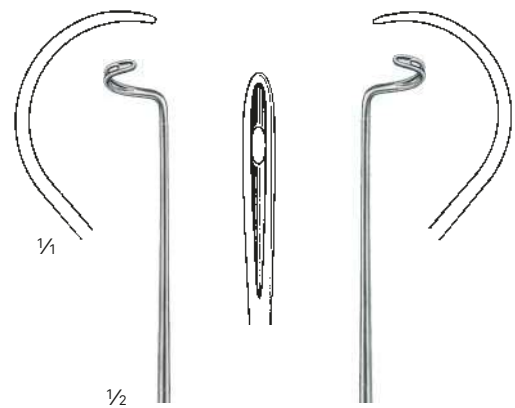

PO 170-27
27 cm / 10 ⁵/₈"
blunt, for right hand

PO 171-27
27 cm / 10 ⁵/₈"
blunt, for left hand



Needle Holders and Suture Instruments

Clip Applying and Removing Forceps



1/1

Michel
PO 218-12
12 cm / 4 7/8"

Probes and Applicators

Grooved Directors

Fistula Probes

Probes

Cotton Applicators





Probes and Applicators

Grooved Directors, Fistula Probes



1/2

SO 205-13
SO 205-14
SO 205-16

13 cm / 5 1/8"
14 cm / 5 3/8"
16 cm / 6 2/8"



1/2

Doyen

SO 206-14
14,5 cm / 5 6/8"



1/2

SO 207-13
SO 207-14
SO 207-16

13 cm / 5 1/8"
14,5 cm / 5 6/8"
16 cm / 6 2/8"



1/2

Nelaton

SO 208-16
16 cm / 6 2/8"



1/2

Broide

SO 209-20
20 cm / 7 7/8"



| | | |
|------------------|------------------|----------|
| SO 200-11 | 11,5 cm / 4 5/8" | ∅ 1,0 mm |
| SO 200-13 | 13 cm / 5 1/8" | ∅ 1,0 mm |
| SO 200-14 | 14,5 cm / 5 6/8" | ∅ 1,0 mm |
| SO 200-16 | 16 cm / 6 2/8" | ∅ 1,0 mm |
| SO 200-18 | 18 cm / 7 1/8" | ∅ 1,0 mm |
| SO 200-20 | 20 cm / 7 7/8" | ∅ 1,0 mm |



| | | |
|------------------|------------------|----------|
| SO 201-11 | 11,5 cm / 4 5/8" | ∅ 2,0 mm |
| SO 201-13 | 13 cm / 5 1/8" | ∅ 2,0 mm |
| SO 201-14 | 14,5 cm / 5 6/8" | ∅ 2,0 mm |
| SO 201-16 | 16 cm / 6 2/8" | ∅ 2,0 mm |
| SO 201-18 | 18 cm / 7 1/8" | ∅ 2,0 mm |
| SO 201-20 | 20 cm / 7 7/8" | ∅ 2,0 mm |
| SO 201-25 | 25 cm / 9 7/8" | ∅ 2,0 mm |

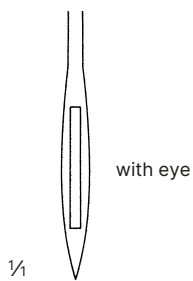

| | | |
|------------------|------------------|----------|
| SO 202-13 | 13 cm / 5 1/8" | ∅ 2,0 mm |
| SO 202-14 | 14,5 cm / 5 6/8" | ∅ 2,0 mm |
| SO 202-16 | 16 cm / 6 2/8" | ∅ 2,0 mm |

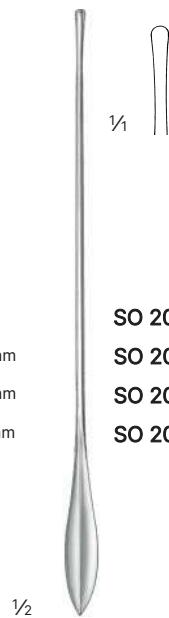

| | | |
|------------------|----------------|----------|
| SO 203-14 | 14 cm / 5 3/8" | ∅ 2,0 mm |
| SO 203-16 | 16 cm / 6 2/8" | ∅ 2,0 mm |
| SO 203-18 | 18 cm / 7 1/8" | ∅ 2,0 mm |
| SO 203-20 | 20 cm / 7 7/8" | ∅ 2,0 mm |

Myrtle Leaf Probe



Stacke
SO 204-10
 ∅ 1 mm
 10,5 cm / 3
 angled handle loop



Probes and Applicators

Cotton Applicators

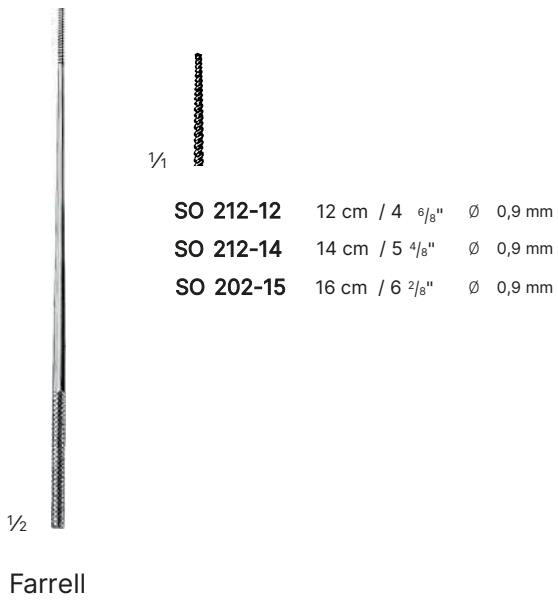

Spreading Instruments

Skin Hooks
Saddle Retractors
Rake Retractors
Thumb Retractors
Double Ended Retractors
Bone Retractors
Lung Spatulas
Scapula Retractors
Pelvis Retractors
Abdominal Retractors
Abdominal Spatulas
Mammoplasty Retractors
Self Retaining Wound Retractor
Self Retaining Abdominal Retractor
Retractor Blades
Self Retaining Abdominal Retractor Frames
OR Table Mounted Retractor System

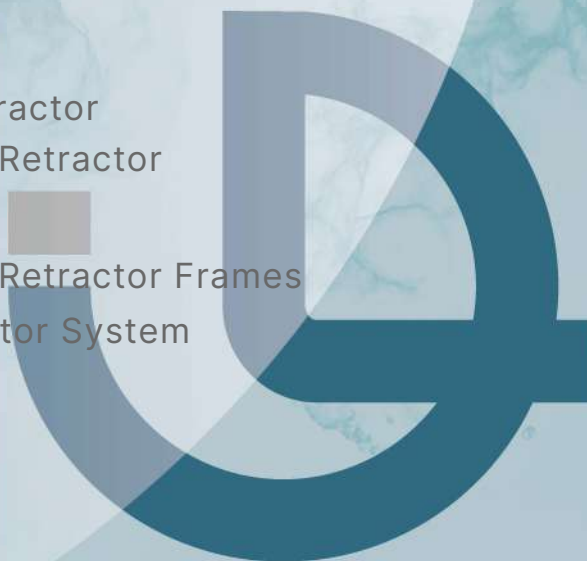



Spreading Instruments

Skin Hooks



1/2

Gillies

18 cm / 7 1/8"



Fig. 1

HO 200-01

small radius, sharp



Fig. 2

HO 200-02

large radius, sharp



1/2

Kilner

HO 201-15

14,5 cm / 5 6/8"

sharp



1/2

Frazier

HO 202-13

13 cm / 5 1/8"

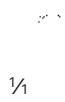

3 mm



HO 203-01

5 mm



HO 203-02

7 mm



HO 203-03



1/2

Kleinert-Kutz

16 cm / 6 2/8"

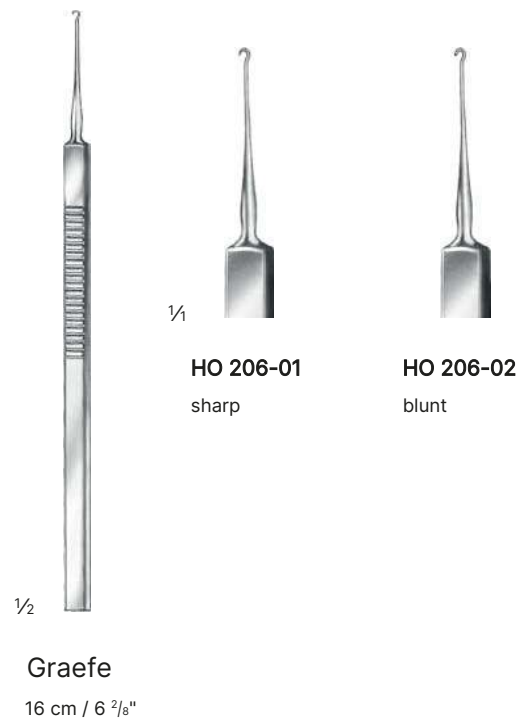
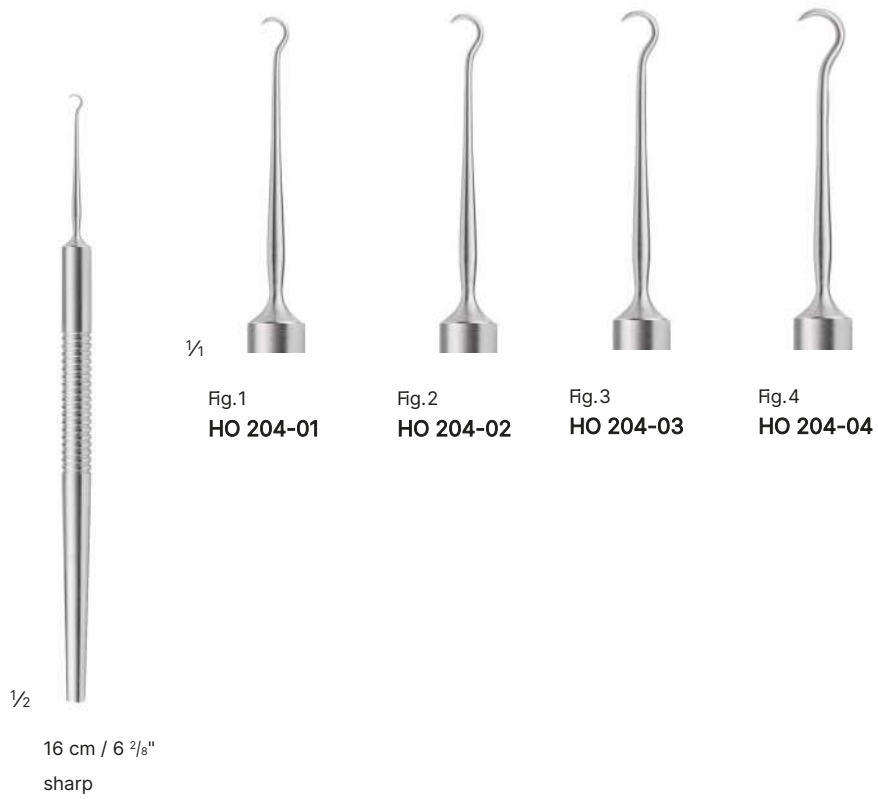



Spreading Instruments

Hooks, Retractors

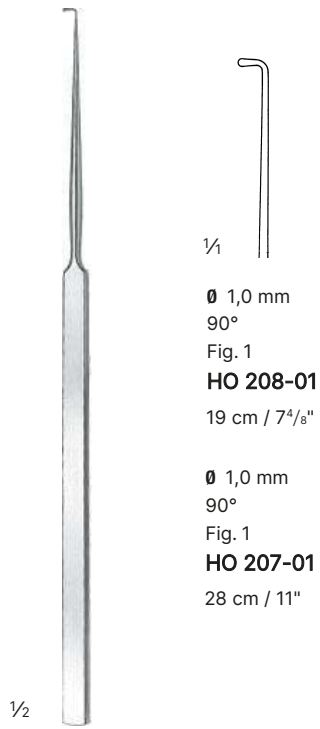

Ø 1,0 mm
90°
Fig. 1
HO 208-01
19 cm / 7⁴/₈"

Ø 1,0 mm
90°
Fig. 1
HO 207-01
28 cm / 11"

1/2

Cushing



1/2

Crile
HO 215-20
20 cm / 7⁷/₈"

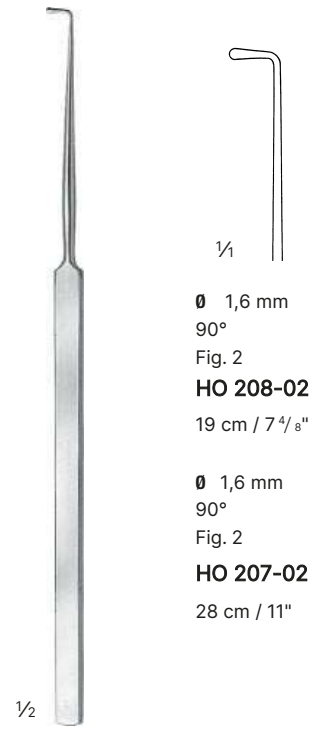

1/2

Cushing

Ø 1,6 mm
90°
Fig. 2
HO 208-02
19 cm / 7⁴/₈"

Ø 1,6 mm
90°
Fig. 2
HO 207-02
28 cm / 11"



1/2

Simon
EK 140-01
21,5 cm / 8⁴/₈"



1/2

Guthrie
16 cm / 6²/₈"



1/4

EK 208-01



EK 208-02



1/2

Knapp
EK 211-13
13 cm / 7⁷/₈"

blunt



1/2

Langenbeck-Green

16 cm / 6 2/8"

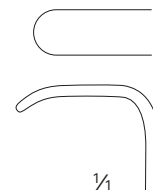

1/4
18 x 6 mm

EK 170-01

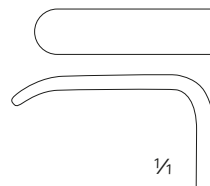

1/4
25 x 6 mm

EK 170-02

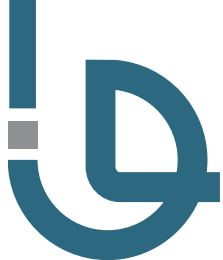

Spreading Instruments

Retractors, Saddle Retractors



Langenbeck-Mannerfelt
15,5 cm / 6 1/4"

1/2



EK 177-01

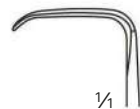

15 x 6 mm

1/4



EK 177-02

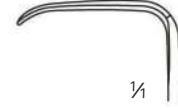

20 x 6 mm

1/4



EK 177-03



25 x 6 mm

1/4



EK 177-04



30 x 8 mm

1/4



Mannerfelt
15,5 cm / 6 1/4"

1/2



1/4

EK 178-01



12mmx12mm



1/4

EK 178-02



12mmx14mm



1/4

EK 178-03



















14mmx16mm



1/2

Mannerfelt

15,5 cm / 6 1/4"

| | | | | |
|--|---|---|---|---|
| |  |  |  |  |
| | sharp | blunt | sharp | blunt |
| | 5mm | 5mm | 8mm | 8mm |
| |  |  |  |  |
| | EK 173-01 | EK 174-01 | EK 175-01 | EK 176-01 |
| | 5mmx4mm | 5mmx4mm | 8mmx8mm | 8mmx8mm |
| |  |  |  |  |
| | EK 173-02 | EK 174-02 | EK 175-02 | EK 176-02 |
| | 5mmx7.2mm | 5mmx7.2mm | 8mmx11mm | 8mmx11mm |
| |  |  |  |  |
| | EK 173-03 | EK 174-03 | EK 175-03 | EK 176-03 |



Spreading Instruments

Hooks, Rake Retractors, Thumb Retractors



sharp

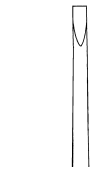

EK 203-01



EK 203-02



EK 203-03



EK 203-04



blunt

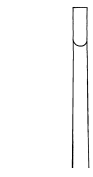

EK 204-01



EK 204-02



EK 204-03



EK 204-04



Fig.1
EK 212-01
blunt
18 x 7 mm



Fig.2
EK 213-02
toothed
16 x 5 mm



Fig.3
EK 212-03
toothed
7 x 4 mm



Fig.4
EK 213-04
blunt
12 x 4 mm



Fig.5
EK 212-05
saddle shaped
8 x 4 mm

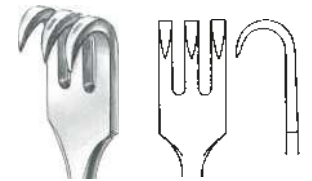
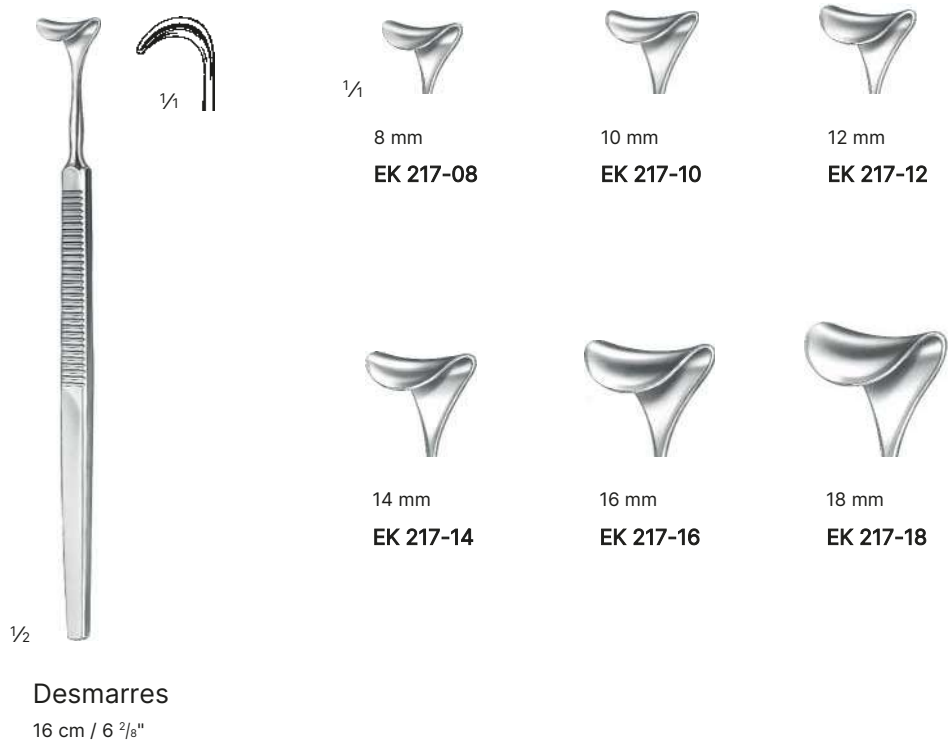
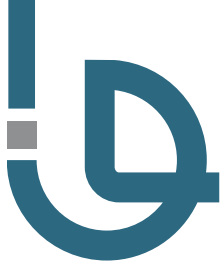

Fig.6
EK 213-06
sharp
7 x 9 mm





Spreading Instruments

Saddle Retractors



Cushing
20,5 cm / 8 1/8"

Cushing
24 cm / 9 4/8"

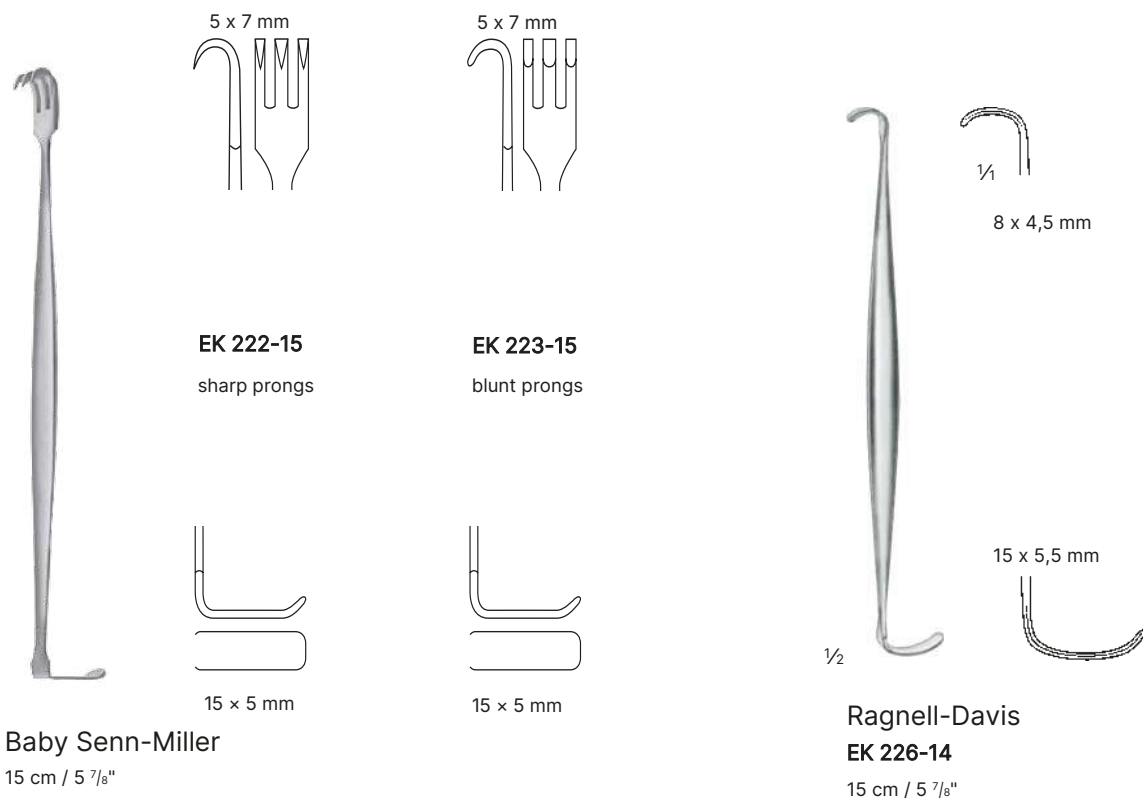
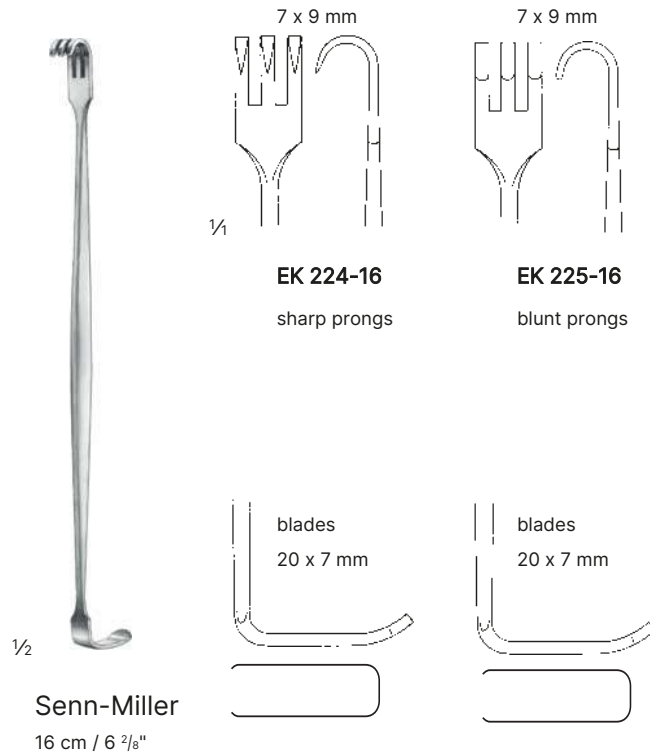



Spreading Instruments

Double Ended Retractors



1/2

Roux

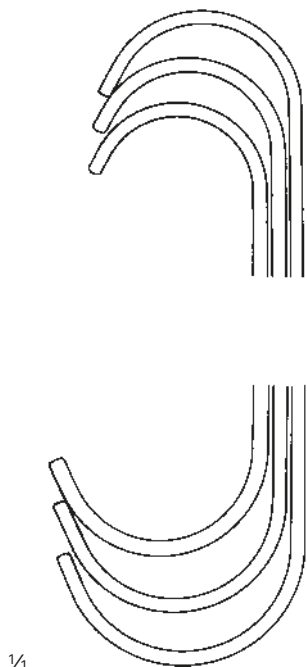

1/4

Fig.1 - 3
EK 396-00
17 cm / 6 5/8"
Set

Fig.1
22 x 21 mm
27 x 29 mm
EK 396-01
14,5 cm / 5 9/16"

Fig.2
25 x 26 mm
30 x 38 mm
EK 396-02
16 cm / 6 2/8"

Fig.3
28 x 29 mm
33 x 43 mm
EK 396-03
17 cm / 6 5/8"



1/2

Roux-Baby
EK 396-04
12,5 cm / 4 7/8"

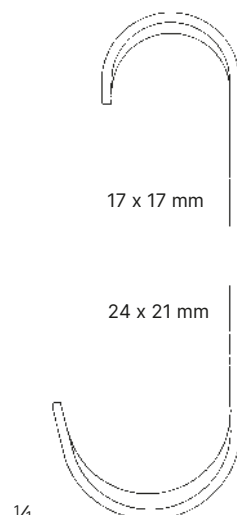

1/4

17 x 17 mm

24 x 21 mm



1/2

Farabeuf
EK 397-00
12 cm / 4 5/8"

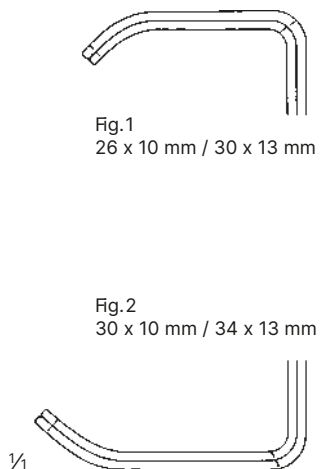

1/4

Fig.1
26 x 10 mm / 30 x 13 mm

Fig.2
30 x 10 mm / 34 x 13 mm



1/2

Farabeuf
EK 398-00
15,5 cm / 6 1/8"

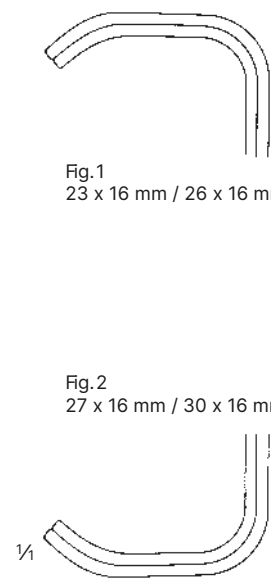

1/4

Fig.1
23 x 16 mm / 26 x 16 mm

Fig.2
27 x 16 mm / 30 x 16 mm



Fig.1
19 x 15 mm / 19 x 15 mm

Fig.2
22 x 15 mm / 22 x 15 mm

Parker
EK 399-00
14 cm / 5 4/8"

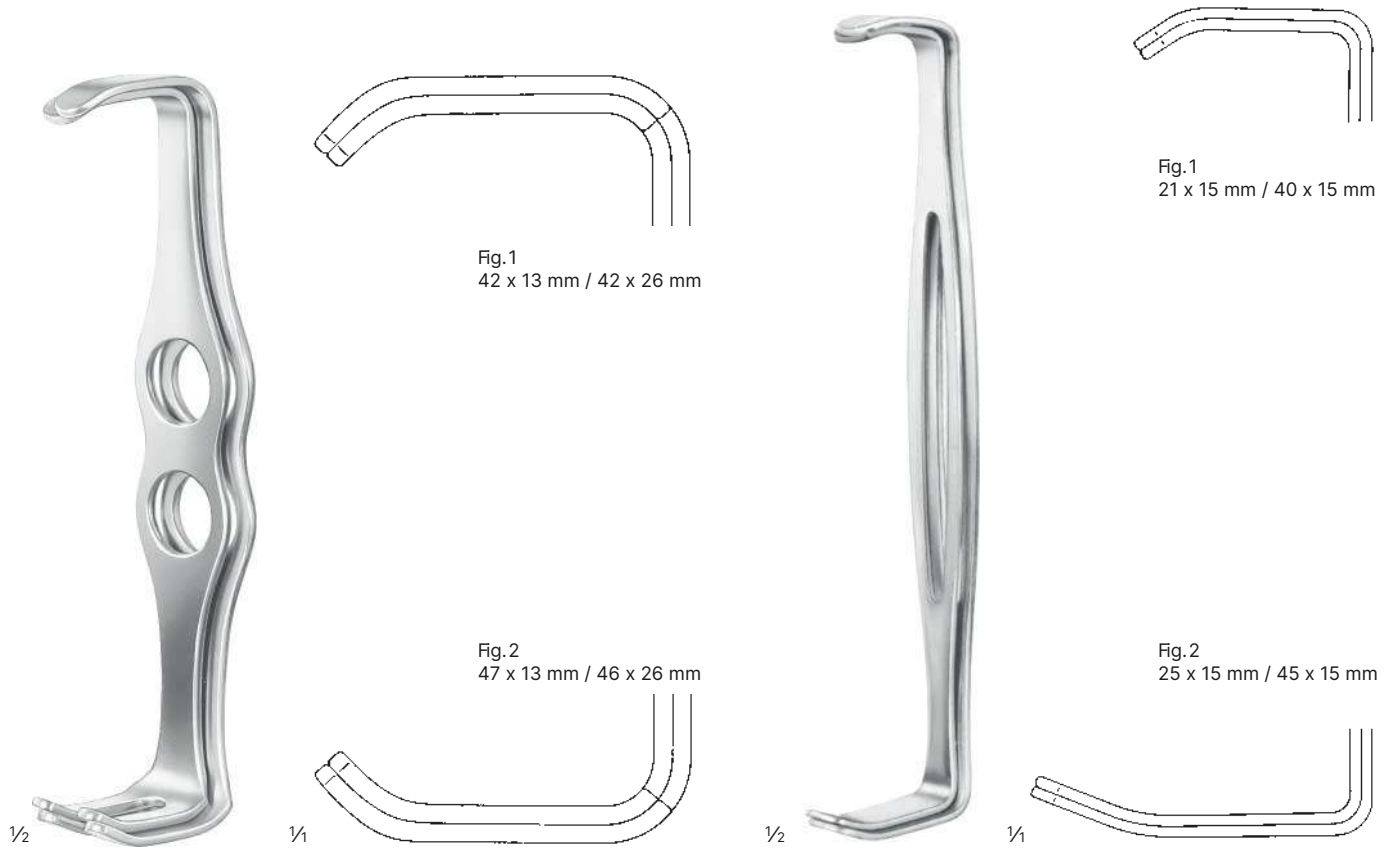

Fig.1
42 x 13 mm / 42 x 26 mm

Fig.2
47 x 13 mm / 46 x 26 mm

Fig.1
21 x 15 mm / 40 x 15 mm

Fig.2
25 x 15 mm / 45 x 15 mm

Mathieu
EK 400-00
20 cm / 7 7/8"

Parker-Langenbeck
EK 401-00
21,5 cm / 8 4/8"



Spreading Instruments

Rake Retractors



sharp

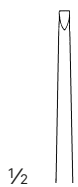

9 mm

EK 229-01



9 x 8 mm

EK 229-02



9 x 13 mm

EK 229-03

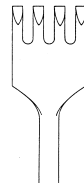

9 x 19 mm

EK 229-04

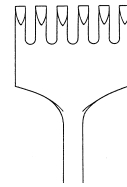

9 x 29 mm

EK 229-06



semi-sharp

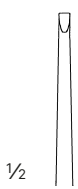

8.5 mm

EK 230-01



8.5 x 8 mm

EK 230-02



8.5 x 13 mm

EK 230-03

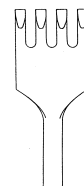

8.5 x 19 mm

EK 230-04

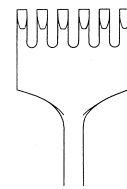

8.5 x 29 mm

EK 230-06

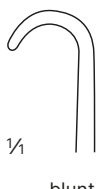

blunt

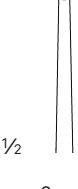

8 mm

EK 231-01



8 x 8 mm

EK 231-02



8 x 13 mm

EK 231-03

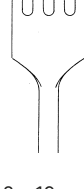

8 x 19 mm

EK 231-04

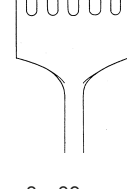

8 x 29 mm

EK 231-06



1/2

Volkmann
22,5 cm / 8 7/8"

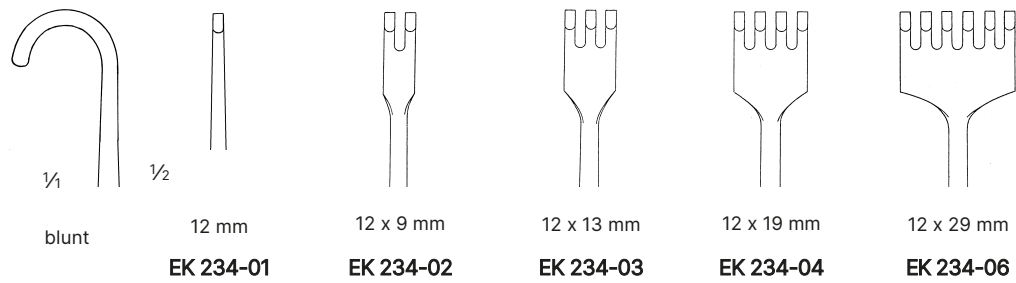
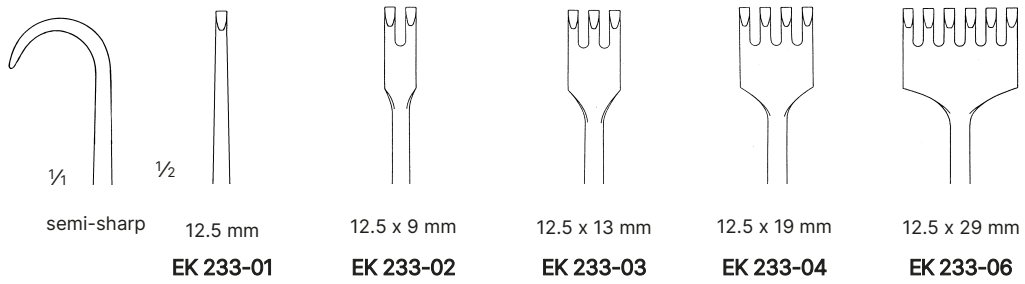
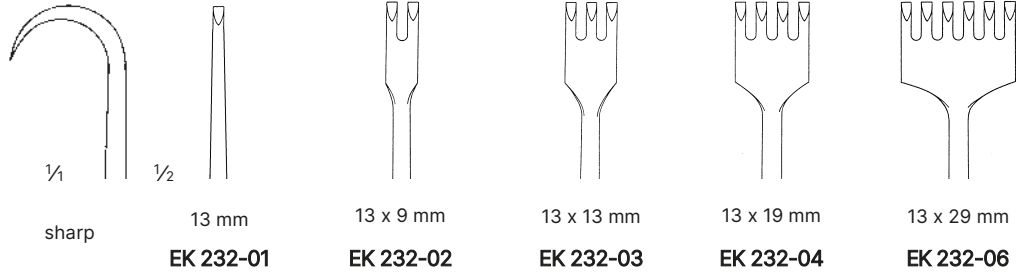

Kocher
22,5 cm / 8 7/8"

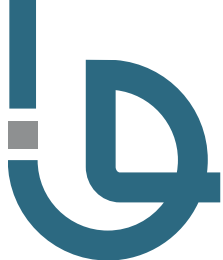

Spreading Instruments

Bone Retractors



Volkmann
EK 235-21

21,5 cm / 8 4/8"
sharp



Volkmann
EK 236-21

21,5 cm / 8 4/8"
blunt



EK 237-20

21,5 cm / 8 4/8"
sharp



1/2

Volkman
21,5 cm / 8 4/8"

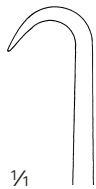

1/4

sharp

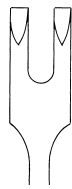

9 x 8 mm

EK 239-01

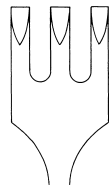

9 x 13 mm

EK 239-02

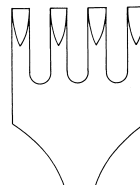

9 x 19 mm

EK 239-03

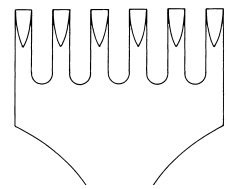

9 x 29 mm

EK 239-04

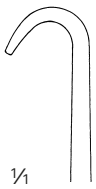

1/4

blunt

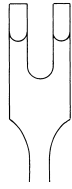

8.5 x 8 mm

EK 239-05

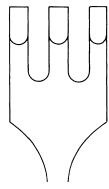

8.5 x 13 mm

EK 239-06

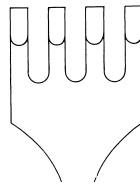

8.5 x 19 mm

EK 239-07

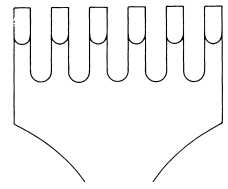

8.5 x 29 mm

EK 239-08



Spreading Instruments

Rake Retractors

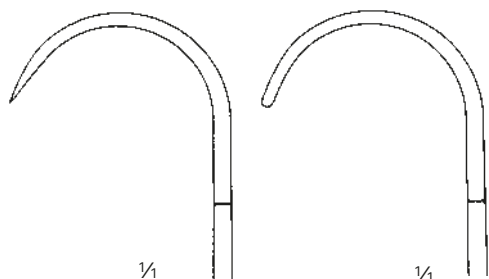

1/4

25 x 40 mm

EK 240-08

sharp

1/4

25 x 40 mm

EK 241-08

blunt



1/2

Körte

24,5 cm / 9 5/8"



1/4

37 x 30 mm

blunt



1/2

Ollier

EK 350-30

24,5 cm / 9 5/8"

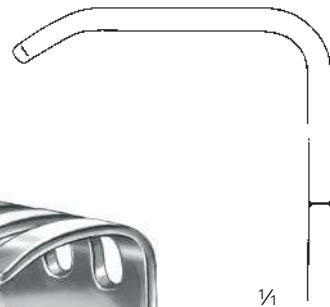

1/4

39 x 60 mm

blunt



1/2

Ollier

EK 350-60

24,5 cm / 9 5/8"



1/4

40 x 40 mm

EK 351-40

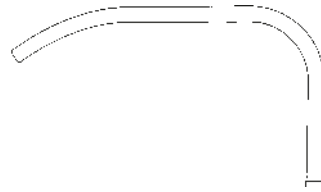

45 x 50 mm

EK 351-50

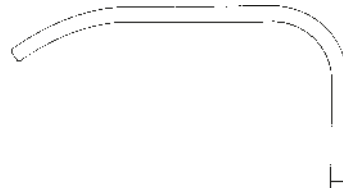

50 x 60 mm

EK 351-60

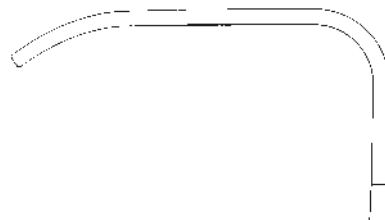

70 x 70 mm

EK 351-70



1/2

Israel

24,5 cm / 9 5/8"

blunt

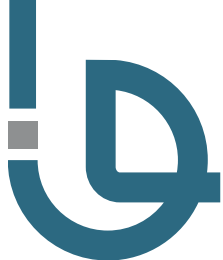

Spreading Instruments

Retractors

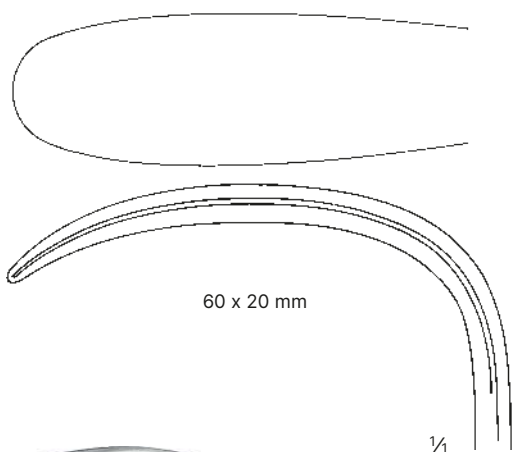

60 x 20 mm

1/4



1/2

Langenbeck

EK 352-01

21 cm / 8 2/8"

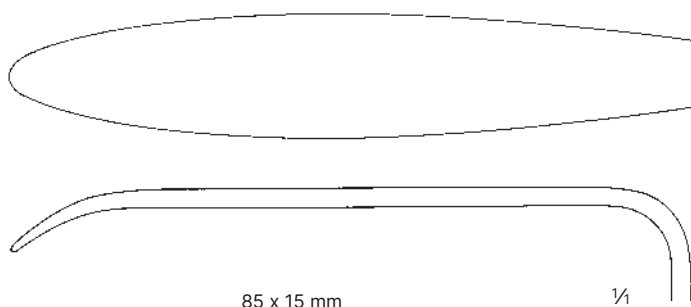

85 x 15 mm

1/4



1/2

Langenbeck

EK 352-02

22,5 cm / 8 7/8"



1/2

Langenbeck
22 cm / 8 5/8"

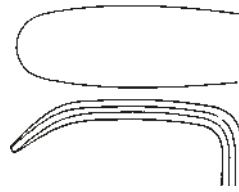

30 x 11 mm
EK 353-01

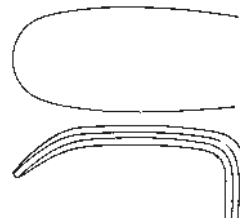

30 x 14 mm
EK 353-02

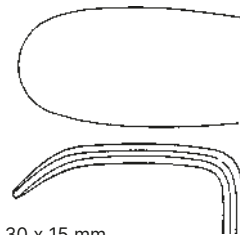

30 x 15 mm
EK 353-03

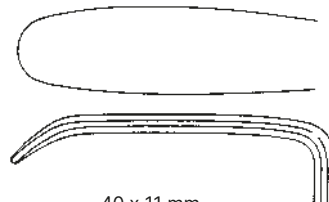

40 x 11 mm
EK 353-04

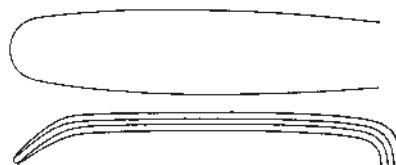

50 x 11 mm
EK 353-05

1/4

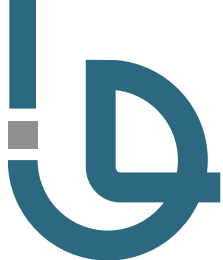

Spreading Instruments

Retractors



1/2

Kocher-Langenbeck

21,5 cm / 8 4/8"

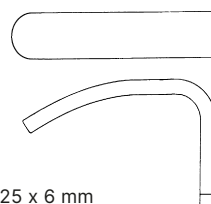

25 x 6 mm
EK 355-01



35 x 8 mm
EK 355-02



35 x 11 mm
EK 355-03



35 x 15 mm
EK 355-04

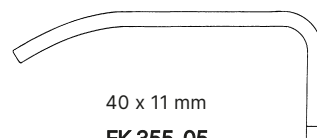

40 x 11 mm
EK 355-05

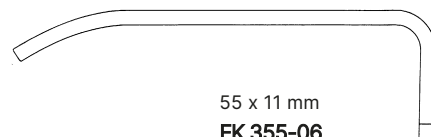

55 x 11 mm
EK 355-06

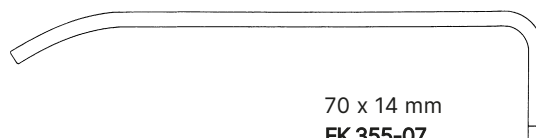

70 x 14 mm
EK 355-07

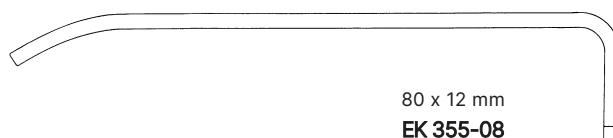

80 x 12 mm
EK 355-08

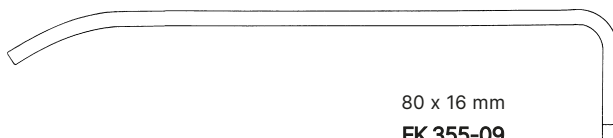

80 x 16 mm
EK 355-09

1/4



Kocher-Langenbeck
21,5 cm / 8 $\frac{4}{8}$ "

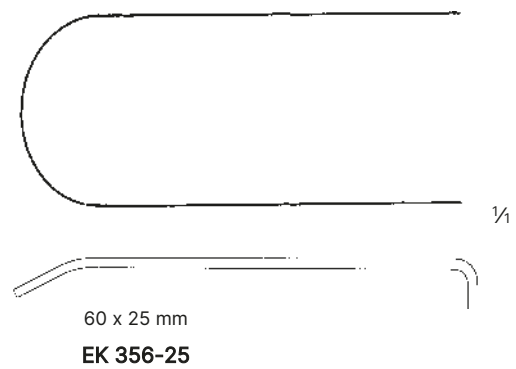
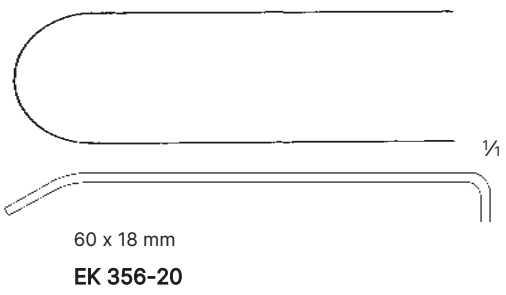
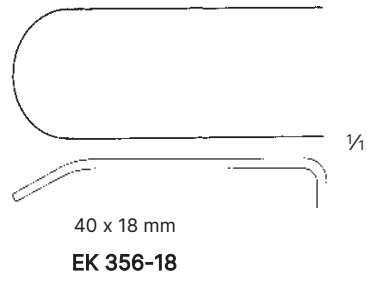



Spreading Instruments

Retractors



$\frac{1}{4}$

45 x 15 mm

EK 357-01

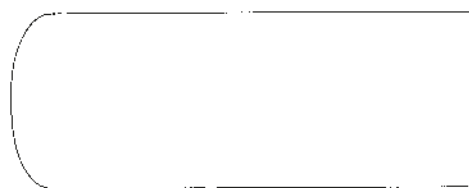

60 x 23 mm

EK 357-02



72 x 20 mm

EK 357-03

90°

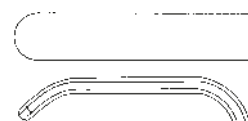

$\frac{1}{4}$

29 x 6 mm



$\frac{1}{2}$

Sauerbruch

22,5 cm / 8 $\frac{7}{8}$ "



$\frac{1}{2}$

Lahey

EK 265-19

19,5 cm / 7 $\frac{5}{8}$ "



$\frac{1}{2}$

Simon

28 cm / 11"

$\frac{1}{2}$

Martin

26,5 cm / 10 $\frac{3}{8}$ "

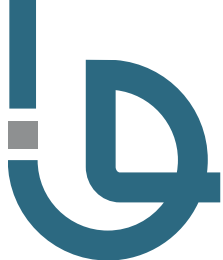

Spreading Instruments

Retractors

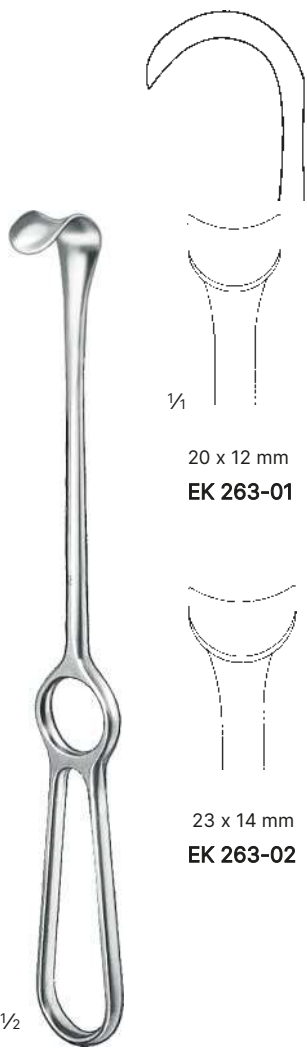

20 x 12 mm
EK 263-01

23 x 14 mm
EK 263-02

1/2

Kocher
21,5 cm / 8 4/8"



1/2

70 x 25 mm
Kocher
EK 375-25
23,5 cm / 9 2/8"



78 x 45 mm
EK 375-42

78 x 55 mm
EK 375-50

78 x 65 mm
EK 375-60

1/2

Kocher
25 cm / 9 7/8"



1/2

Kocher-Wagner
28cm / 11 1/32"

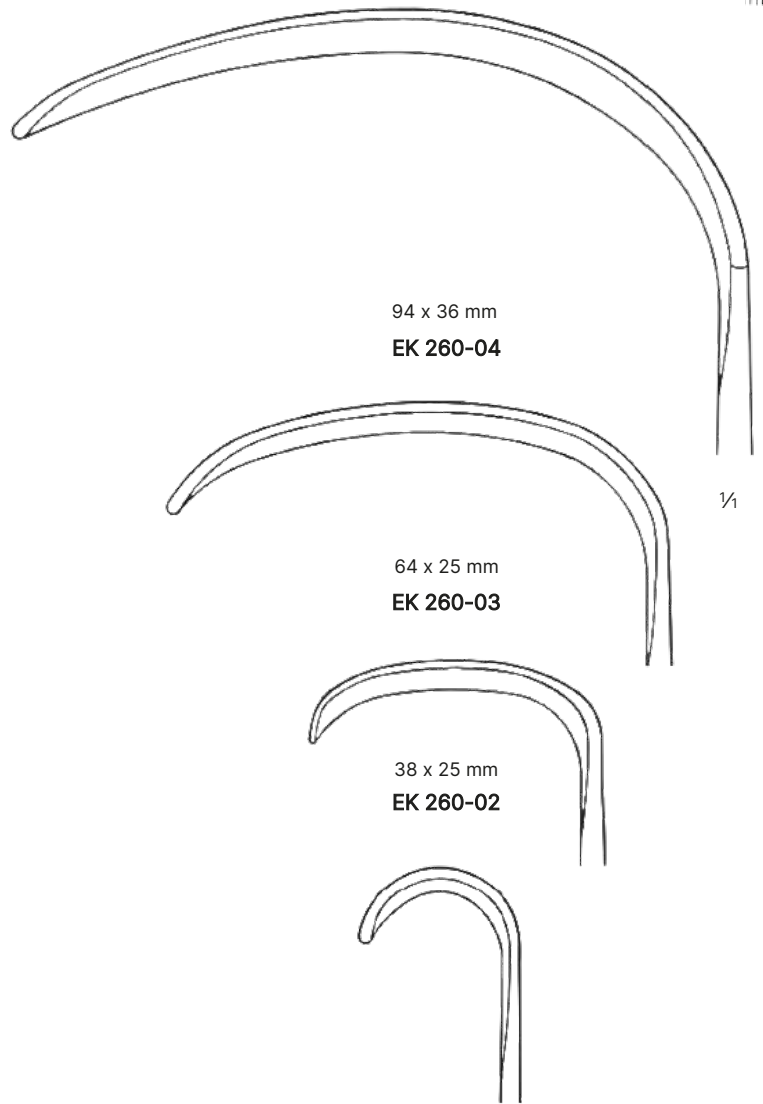

94 x 36 mm
EK 260-04

64 x 25 mm
EK 260-03

38 x 25 mm
EK 260-02

20 x 15 mm
EK 260-01



Spreading Instruments

Retractors



$\frac{1}{2}$
Hösel
26 cm / 10 $\frac{2}{8}$ "

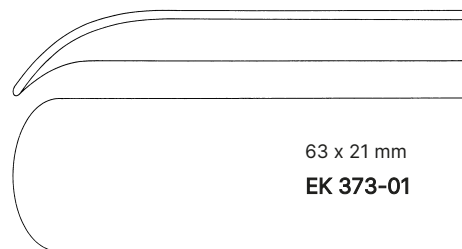

63 x 21 mm
EK 373-01

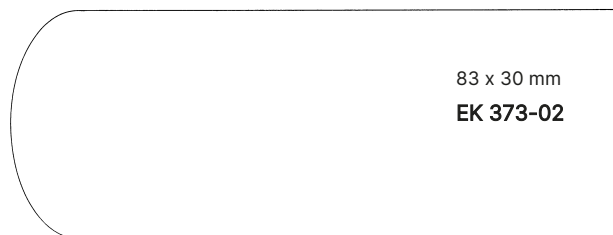

83 x 30 mm
EK 373-02

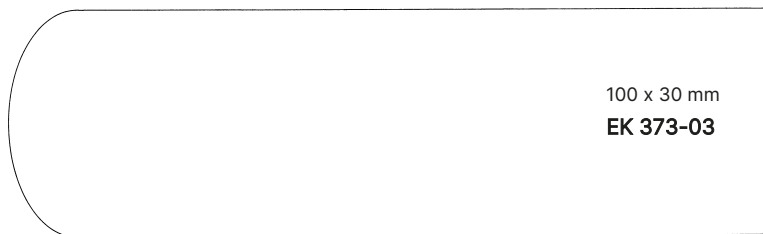

100 x 30 mm
EK 373-03

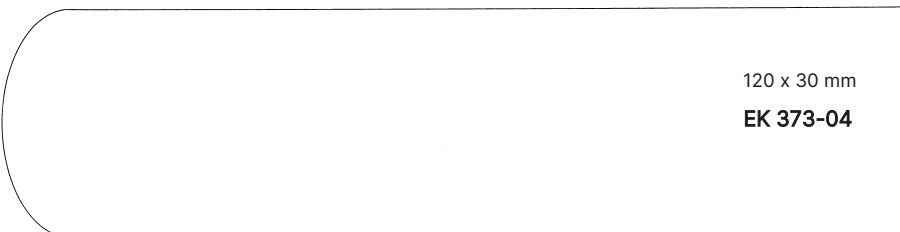

120 x 30 mm
EK 373-04

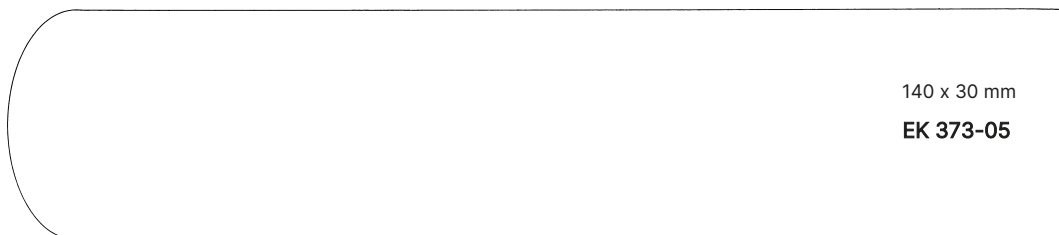

140 x 30 mm
EK 373-05

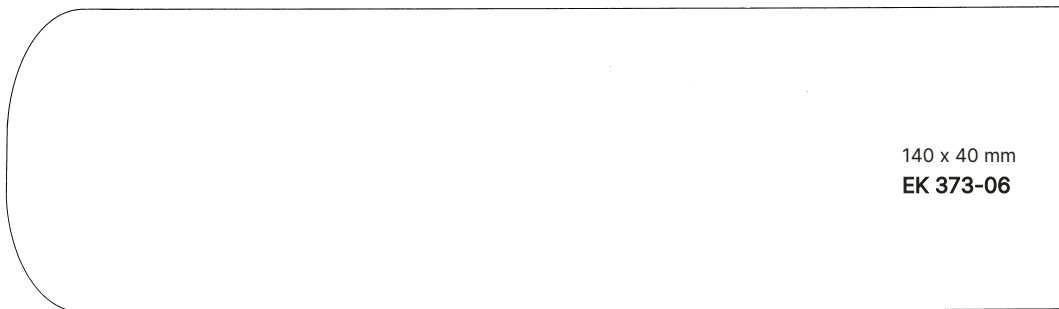

140 x 40 mm
EK 373-06

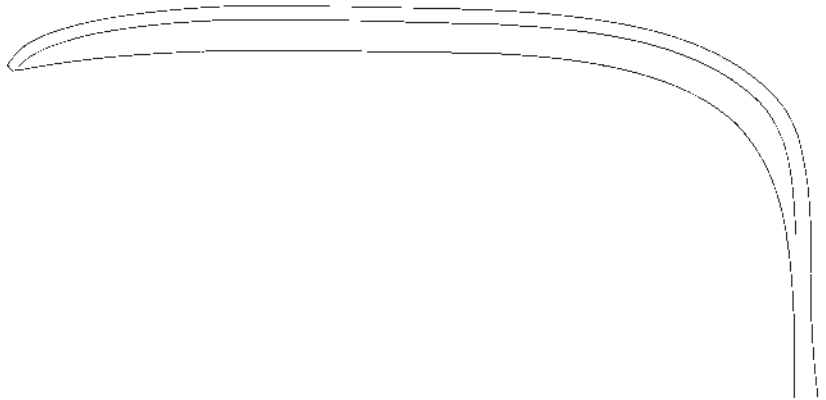

87 x 28 mm
EK 376-30
25 cm / 9 ⁷/₈"

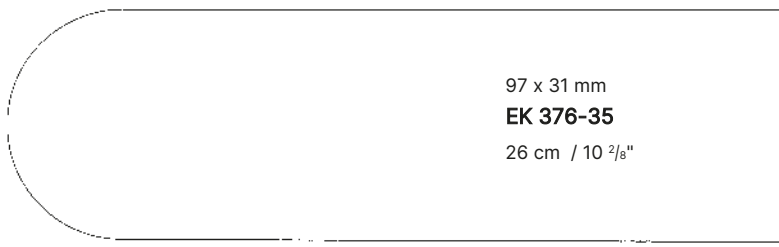

97 x 31 mm
EK 376-35
26 cm / 10 ²/₈"

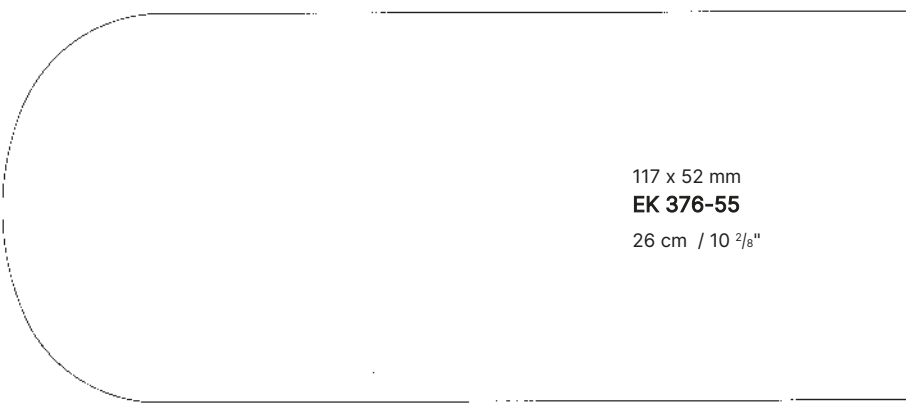

117 x 52 mm
EK 376-55
26 cm / 10 ²/₈"



1/2

1/4

Doyen-Stille

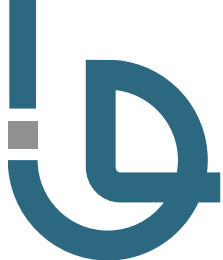
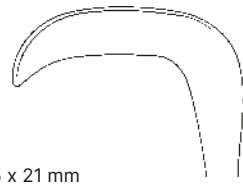

Fig.1
EK 372-01
26 cm / 10 ²/₈"
25 x 20 mm
30 x 28 mm

Fig.2
EK 372-02
27,5 cm / 10 ⁷/₈"
43 x 38 mm
63 x 44 mm

1/2

Richardson-Eastman



25 x 21 mm

EK 371-01

24 cm / 9 4/8"



1/2

Richardson

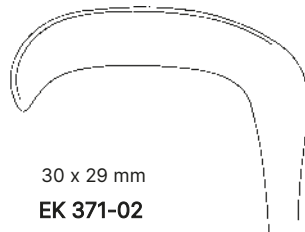

30 x 29 mm

EK 371-02

24 cm / 9 4/8"



48 x 22 mm

1/2

Richardson

EK 371-04

24 cm / 9 4/8"

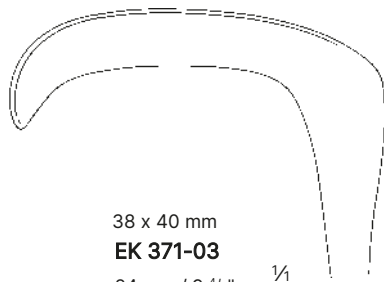

38 x 40 mm

EK 371-03

24 cm / 9 4/8"

1/4



62 x 50 mm

1/2

Kelly

EK 371-54

26 cm / 10 2/8"

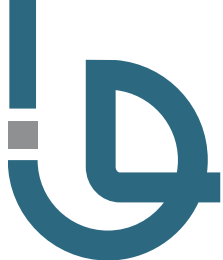

Spreading Instruments

Retractors, Lung Spatulas

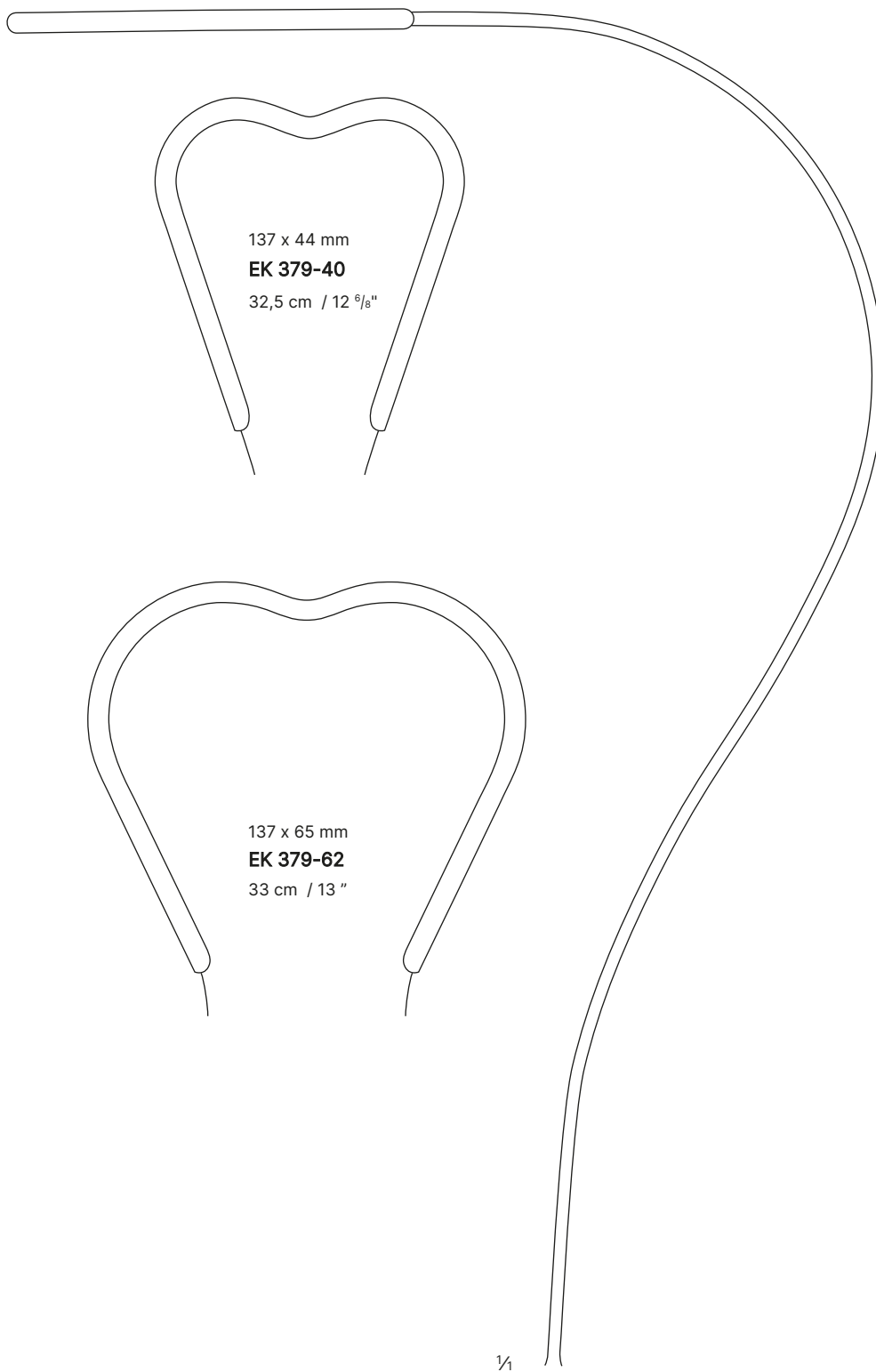

1/2

Harrington

flexible

1/1



KA 650-01
29,5 cm / 11⁵/₈"
Working width
40 mm

KA 650-02
33 cm / 13"
Working width
53 mm

1/2

Allison



1/2

Allison
KA 651-01

29,5 cm / 11⁵/₈"



Spreading Instruments

Retractors

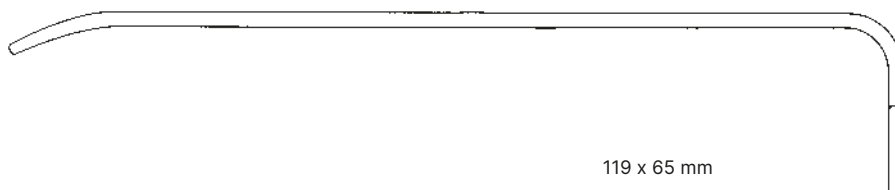

119 x 65 mm

EK 391-65



108 x 43 mm

EK 391-38

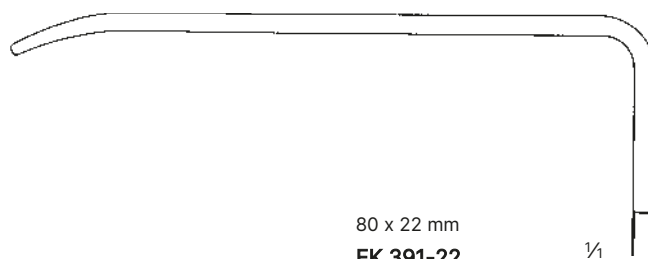

80 x 22 mm

EK 391-22

¼



½

Coryllos

24 cm / 9 4/8"



1/2

80 x 54 mm
Davidson
EK 394-50
19 cm / 7 1/8"



1/2

75 x 93 mm
Davidson
EK 394-90
19 cm / 7 1/8"

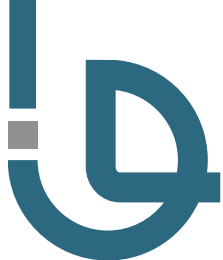

Spreading Instruments

Retractors



1/2

19 mm
Deaver
EK 383-01
18 cm / 7 1/8"

22 mm
Deaver
EK 383-02
21,5 cm / 8 4/8"

25 mm
Deaver
EK 383-03
26 cm / 10 2/8"

25 mm
Deaver
EK 383-04
30,5 cm / 12"

25 mm
Deaver
EK 383-05
33,5 cm / 13 2/8"

25 mm
Deaver
EK 383-06
34,5 cm / 13 5/8"



1/2

38 mm
Deaver
EK 383-07
32 cm / 12 5/8"



50 mm
Deaver
EK 383-08
31,5 cm / 12 3/8"



75 mm
Deaver
EK 383-09
31,5 cm / 12 3/8"



Spreading Instruments

Retractors



1/2

Deaver

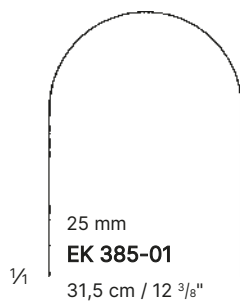

25 mm

EK 385-01

31,5 cm / 12 3/8"

1/1

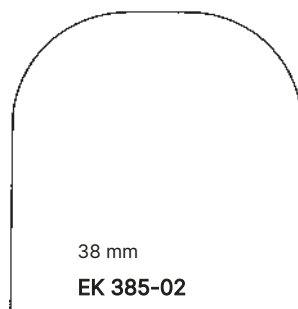

38 mm

EK 385-02

31,5 cm / 12 3/8"

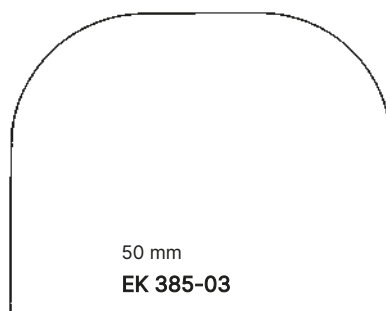

50 mm

EK 385-03

31,5 cm / 12 3/8"

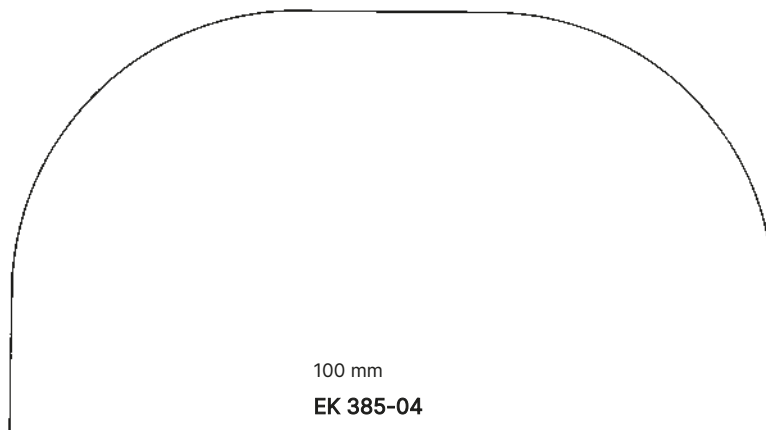

100 mm

EK 385-04

32,5 cm / 12 9/8"

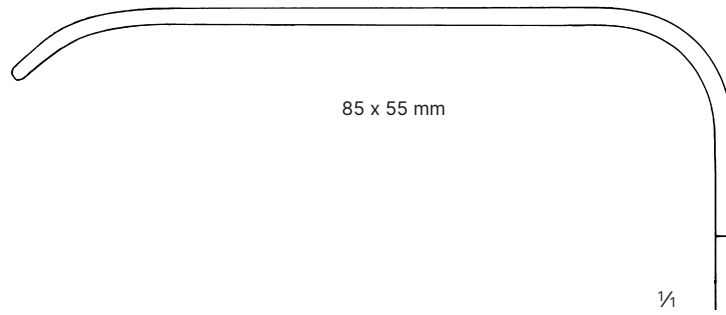

$\frac{1}{2}$

Mikulicz
EK 380-26

26 cm / 10 $\frac{7}{8}$ "



Spreading Instruments

Retractors

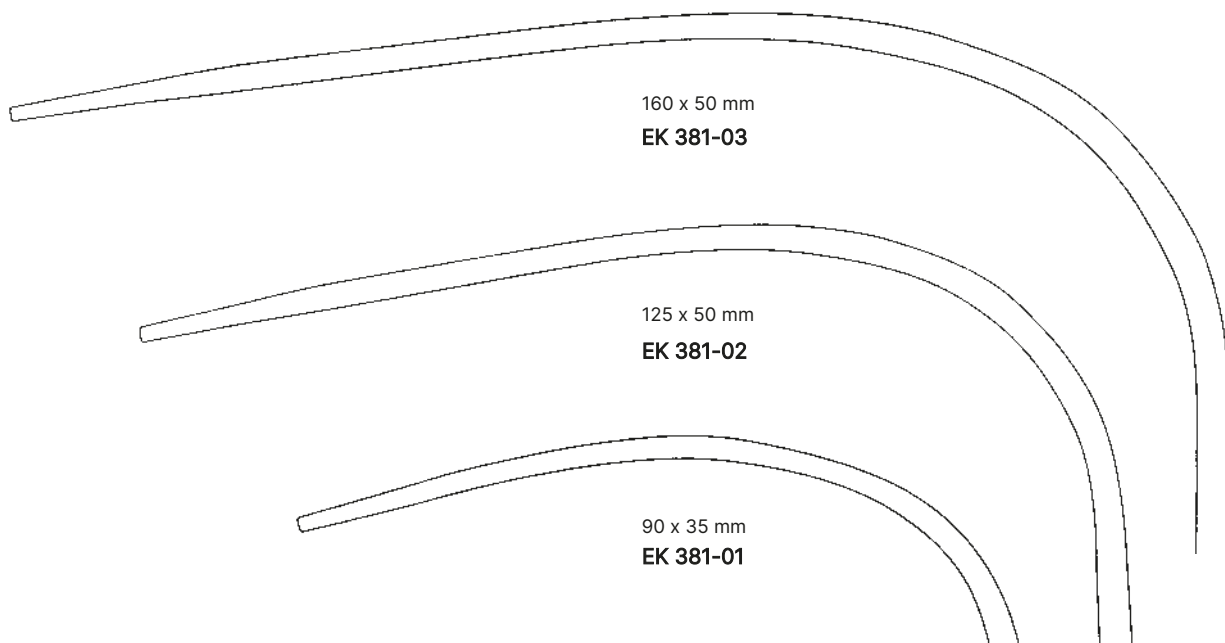

Mikulicz

25 cm / 9 7/8"



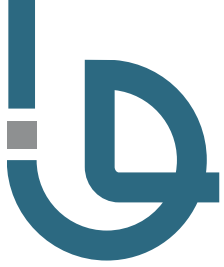

Spreading Instruments
Pelvis Retractors

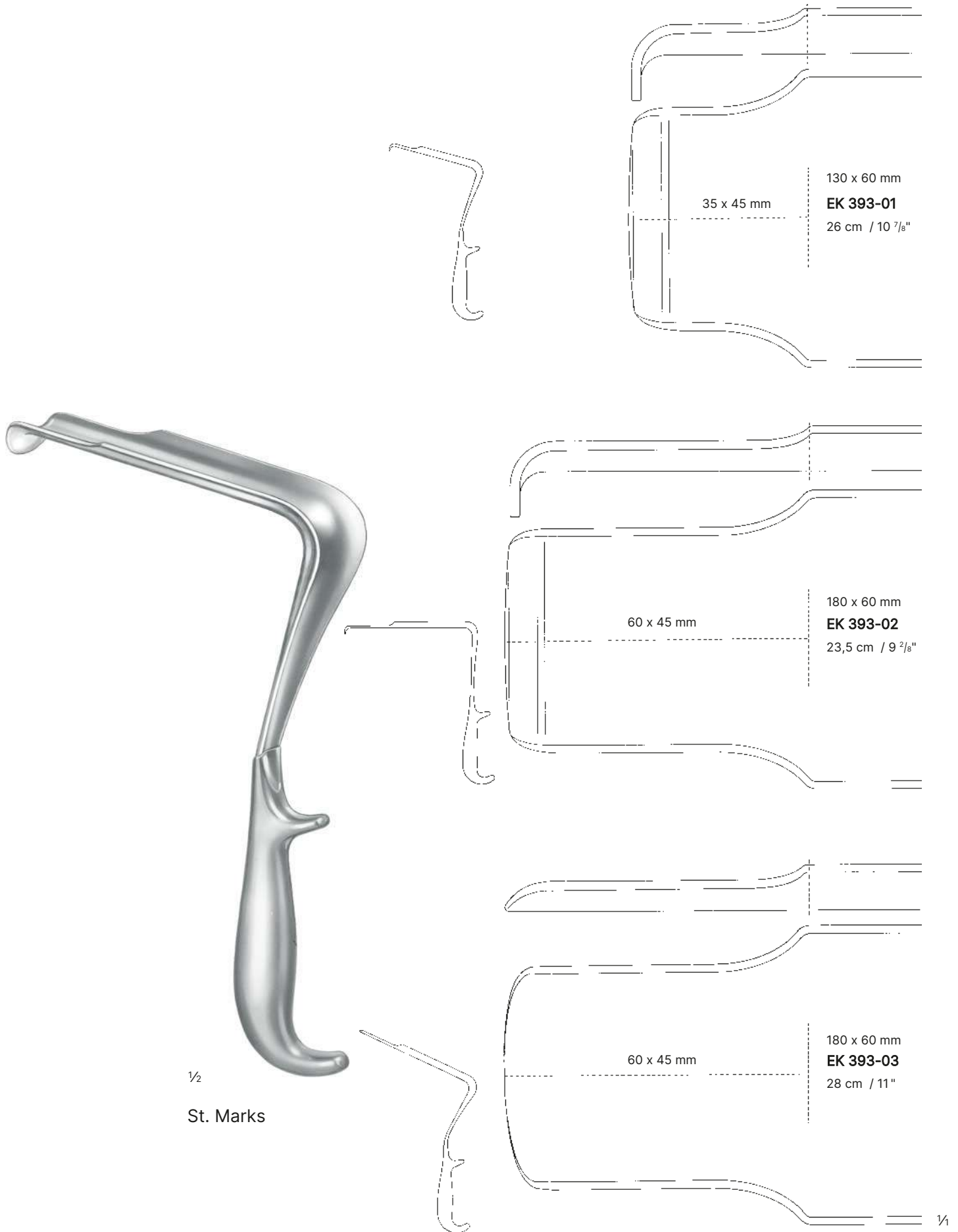



1/2

Tuffier
EK 378-23
 23,5 cm / 9 2/8"



1/2

Doyen

- EK 265-35** 58 x 35 mm
- EK 266-35** 88 x 35 mm
- EK 267-35** 118 x 35 mm

- EK 265-45** 60 x 47 mm
- EK 266-45** 95 x 47 mm
- EK 267-45** 20 x 47 mm
- EK 268-45** 165 x 47 mm

- EK 265-60** 55 x 60 mm
- EK 266-60** 85 x 60 mm
- EK 267-60** 115 x 60 mm

- EK 268-60** 160 x 60 mm

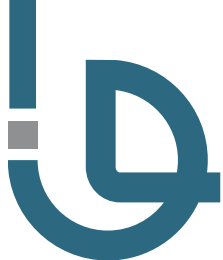

1/2

Fritsch

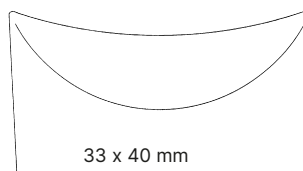

33 x 40 mm

EK 374-40

24 cm / 9 4/8"

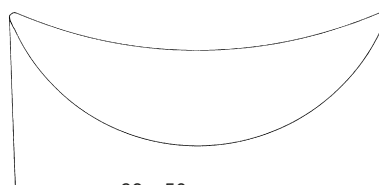

39 x 50 mm

EK 374-50

25 cm / 9 6/8"

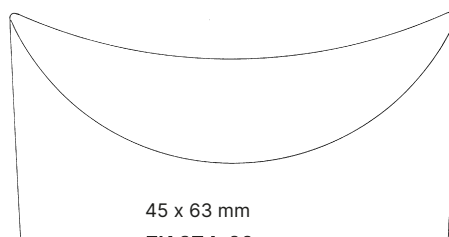

45 x 63 mm

EK 374-60

25 cm / 9 6/8"

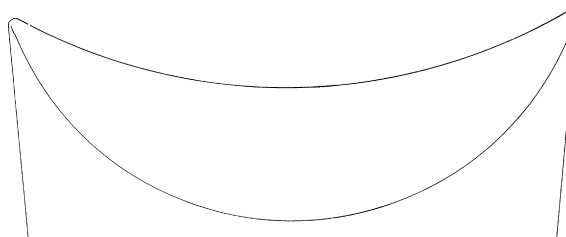

45 x 75 mm

EK 374-75

25,5 cm / 10"

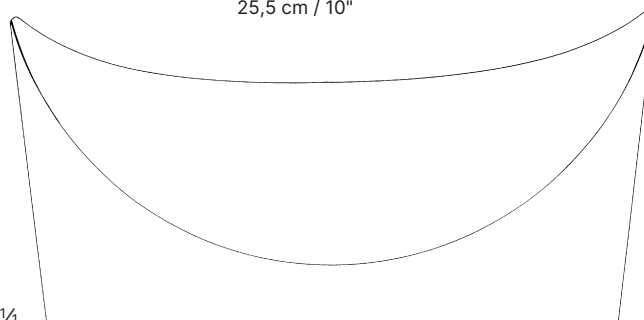

1/1

53 x 85 mm

EK 374-85

25,5 cm / 10"



$\frac{2}{3}$

45 x 88 mm

Doyen

EK 377-25

24 cm / 9 $\frac{4}{8}$ "

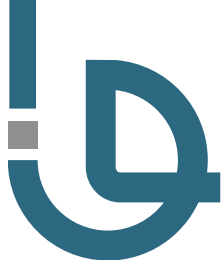

Spreading Instruments

Abdominal Spatulas



1/2

malleable

EK 552-30

33 cm / 13 "
30 mm

EK 552-40

33 cm / 13 "
40 mm

EK 552-50

33 cm / 13 "
50 mm



1/2

Haberer

tapered

EK 554-30

20 cm / 7 7/8 "
16 mm - 25 mm

EK 554-45

28 cm / 11 "
25 mm - 30 mm

EK 554-50

30 cm / 11 5/8 "
37 mm - 45 mm



1/2

very soft malleable

EK 550-12

20 cm / 7 7/8 "
6,5 mm

EK 550-17

20 cm / 7 7/8 "
9,5 mm

EK 550-20

20 cm / 7 7/8 "
13 mm

EK 550-25

20 cm / 7 7/8 "
16 mm

EK 551-25

20 cm / 7 7/8 "
25 mm



Reverdin

EK 555-29

28 cm / 11 1/2 "
45 mm / 63 mm



- EK 354-01** 90mmX24mm
- EK 354-02** 90mmX30mm
- EK 354-03** 150mmX36mm
- EK 354-04** 190mmX30mm



Spreading Instruments
Self Retaining Wound Retractors



1/2

Finsen

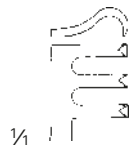

1/4

EK 420-05

5 cm / 2"
sharp



2x3



16 mm



EK 421-05

5 cm / 2"
blunt



2x3

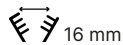

16 mm



EK 420-07

7 cm / 2 6/8"
sharp



3x4



20 mm

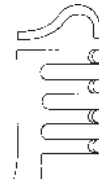

EK 421-07

7 cm / 2 6/8"
blunt



3x4



20 mm



1/2

Alm

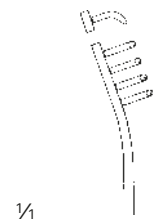

1/4

EK 424-07

7 cm / 2 6/8"
sharp



4x4

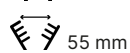

55 mm



EK 424-10

10 cm / 3 7/8"
sharp



4x4

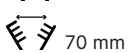

70 mm



EK 425-07

7 cm / 2 6/8"
blunt



4x4



55 mm



EK 425-10

10 cm / 3 7/8"
blunt



4x4

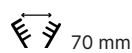

70 mm



1/2

Jansen
10 cm / 3 7/8"

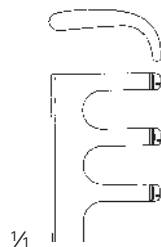

1/4

EK 428-01

blunt



3x3



47 mm

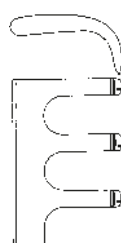

EK 428-02

sharp



3x3



47 mm

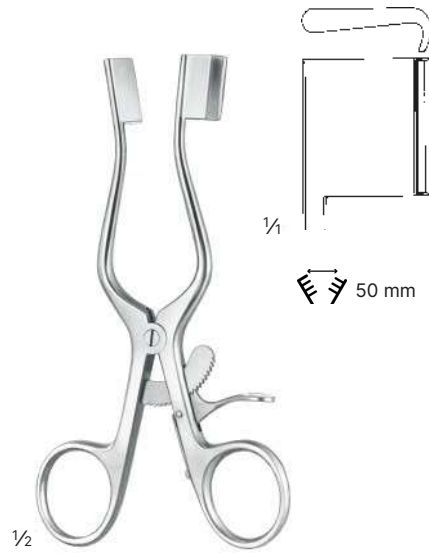

Weitlaner-Baby
EK 433-13
13,5 cm / 5 3/8"



Weitlaner
13,5 cm / 5 3/8"

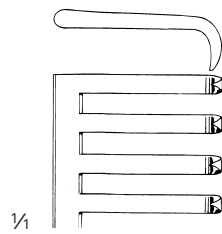

EK 433-13

sharp

 3x4

 43 mm

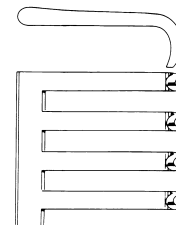

EK 434-13

blunt

 3x4

 43 mm



Spreading Instruments

Self Retaining Wound Retractors



Weitlaner
11 cm / 4 3/8"

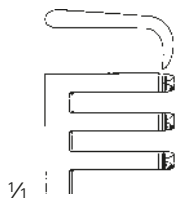

EK 435-10

sharp

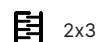

40 mm

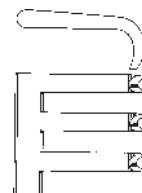

EK 436-10

blunt

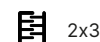

40 mm



Weitlaner



EK 435-13

13,5 cm / 5 3/8"

sharp

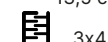

43 mm

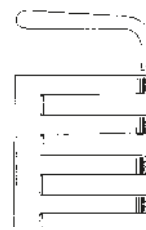

EK 435-16

16 cm / 6 2/8"

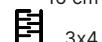

83 mm



EK 436-13

13,5 cm / 5 3/8"

blunt

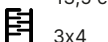

43 mm

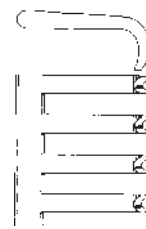

EK 436-16

16 cm / 6 2/8"

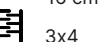

83 mm



1/2

Weitlaner

sharp

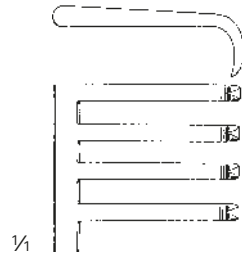

1/4

EK 435-20

20 cm / 7 7/8"

3x4
90 mm

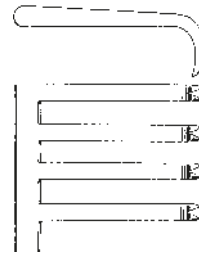

EK 435-25

24 cm / 9 4/8"

3x4
90 mm

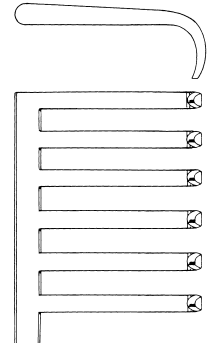

EK 435-26

25,5 cm / 10"

5x6
90 mm

blunt

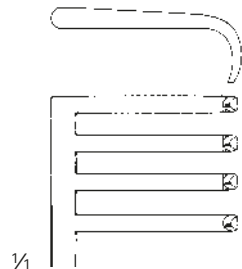

1/4

EK 436-20

20 cm / 7 7/8"

3x4
90 mm

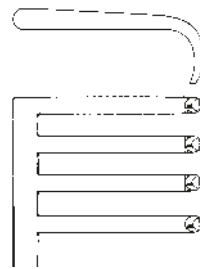

EK 436-25

24 cm / 9 4/8"

3x4
90 mm

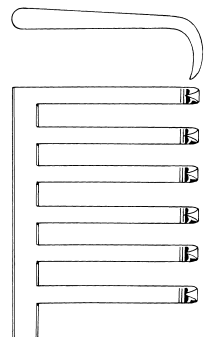

EK 436-26

25,5 cm / 10"

5x6
90 mm



Spreading Instruments

Self Retaining Wound Retractors

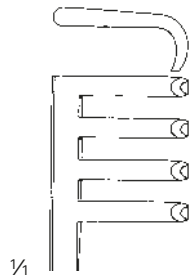

EK 438-00

blunt



EK 437-00

sharp



1/2

Henley
EK 437-00
EK 438-00

16,5 cm / 6 4/8"



complete with 3 central blades
ref. EK 437-19, EK 437-25 and
EK 437-32



1/2

EK 437-19

19 x 17 mm



EK 437-25

25 x 17 mm



EK 437-32

32 x 17 mm



Milligan
EK 440-13
13,5 cm / 5 3/8"

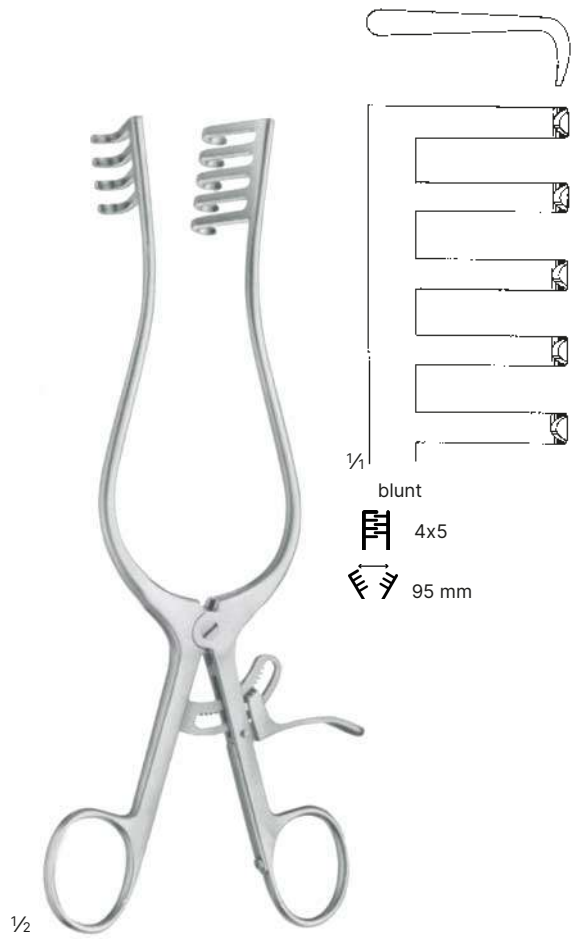
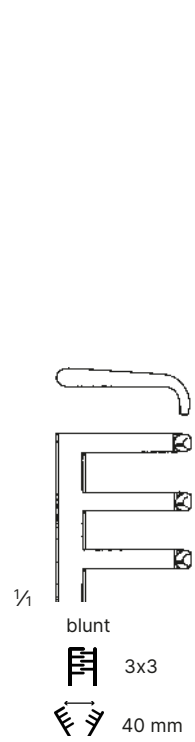

Travers
EK 441-21
21 cm / 8 1/8"

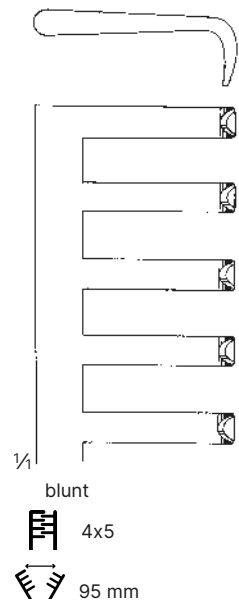



Spreading Instruments

Self Retaining Wound Retractors



1/2

Weitlaner-Wullstein
13 cm / 5 1/8"

1/4

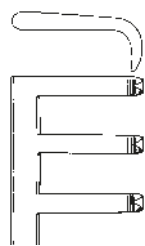

EK 444-13

sharp

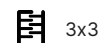

3x3



40 mm

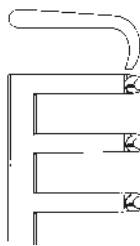

EK 445-13

blunt

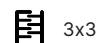

3x3



40 mm



1/2

Mollison
EK 446-15
15,5 cm / 6 1/8"

1/4

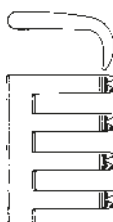

sharp



4x4



80 mm



1/2

Anderson-Adson
EK 452-20
19 cm / 7 4/8"

1/4

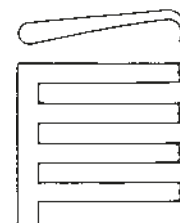

sharp



4x4



84 mm

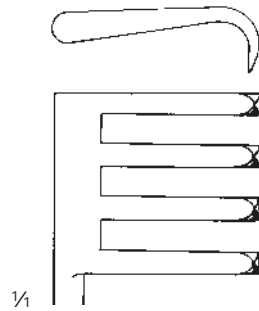

1/4

EK 454-27

26 cm / 10 2/8"

sharp

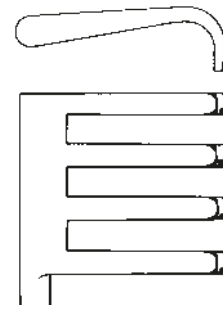
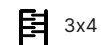

EK 455-27

26 cm / 10 2/8"

blunt

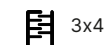

1/2

Adson

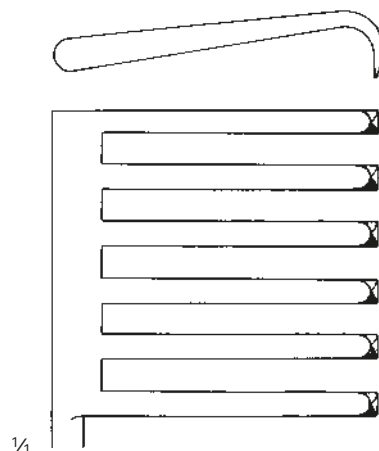

1/4

EK 456-27

29 cm / 11 3/8"

sharp

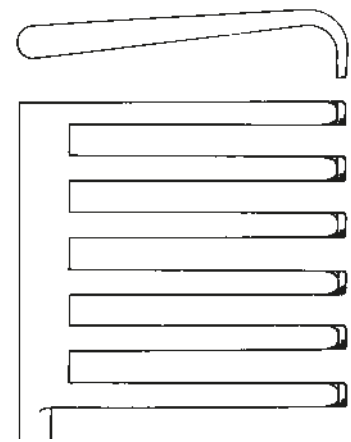

EK 457-27

29 cm / 11 3/8"

blunt



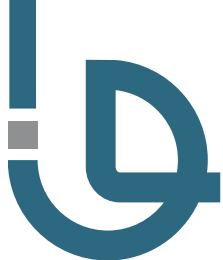

Spreading Instruments

Self Retaining Wound Retractors

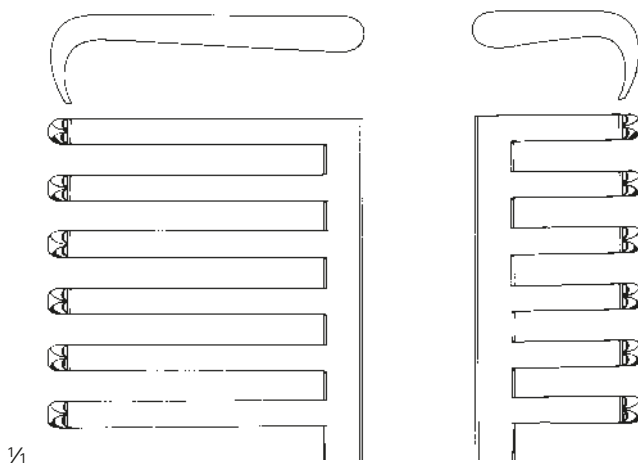

EK 457-01
sharp, long teeth on left side

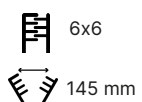

EK 457-01
sharp, long teeth on left side



6x6



145 mm

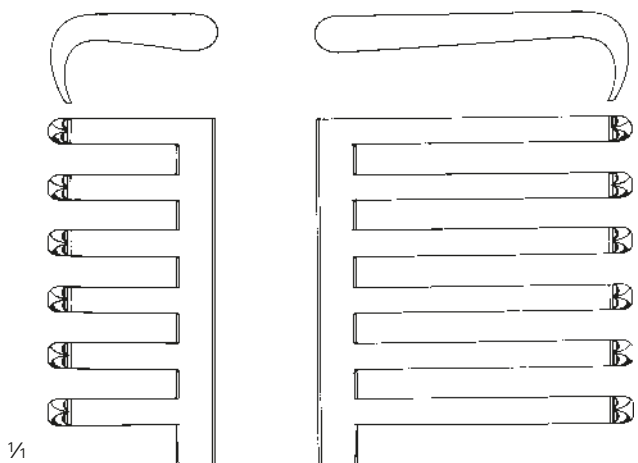

EK 457-02
sharp, long teeth on right side

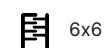

6x6



145 mm



1/2

Adson
28,5 cm / 11 2/8"

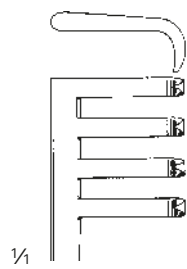

1/1

EK 458-13

14 cm / 5 4/8"

sharp



3x4



81 mm

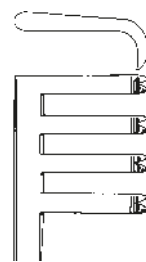

EK 458-16

16,5 cm / 6 4/8"

3x4

90 mm



EK 458-20

21 cm / 8 2/8"

3x4

135 mm

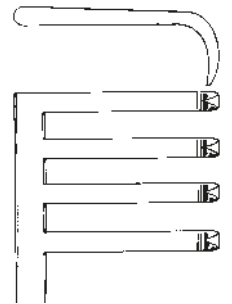

EK 458-25

24,5 cm / 9 5/8"

3x4

135 mm

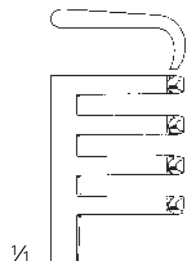

1/1

EK 459-13

14 cm / 5 4/8"

blunt



3x4



81 mm



EK 459-16

16,5 cm / 6 4/8"

3x4

90 mm



EK 459-20

21 cm / 8 2/8"

3x4

135 mm

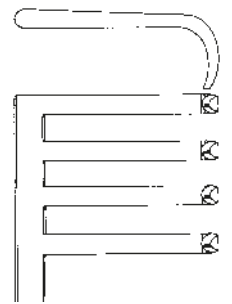

EK 459-25

24,5 cm / 9 5/8"

3x4

135 mm



Spreading Instruments
Self Retaining Wound Retractors



Beckmann
EK 460-31
32 cm / 12 5/8"
sharp

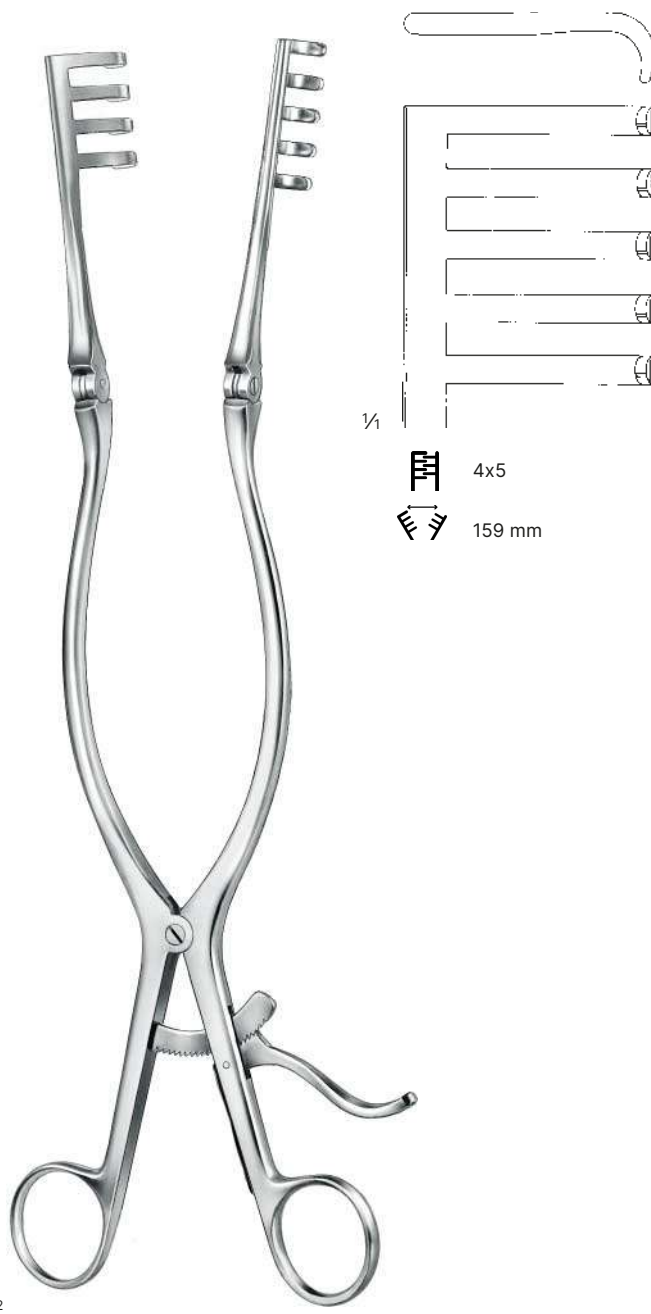

Beckmann
EK 463-33
33 cm / 13 "
blunt



1/2

Beckman-Adson

 142 mm

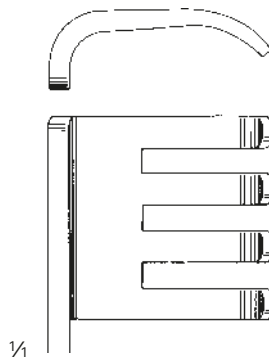

1/1

EK 464-01

31 cm / 12 2/8"

blunt

 4x4

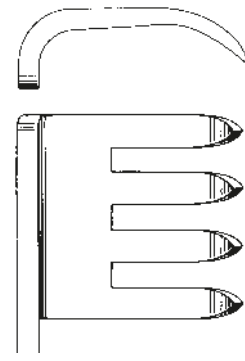

EK 464-02

31 cm / 12 2/8"

sharp

 4x4

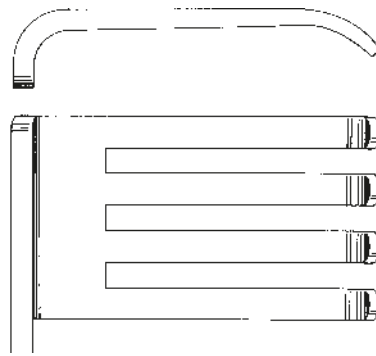

EK 464-03

31 cm / 12 2/8"

blunt

 4x4

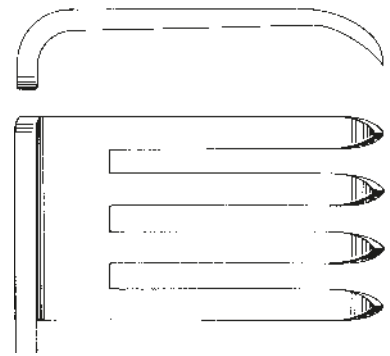

EK 464-04

31 cm / 12 2/8"

sharp

 4x4



1/2

Beckman-Eaton



EK 466-33

32 cm / 12 5/8"

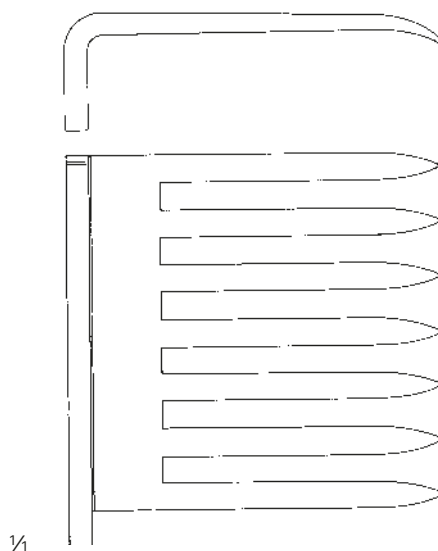
sharp



1/4

 7x7
 159 mm



1/2

Joll
EK 467-14
15,5 cm / 6 1/8"
Thyroid and Vaginal retractor



1/2

Gelpi
EK 469-14
13 cm / 5 1/8"

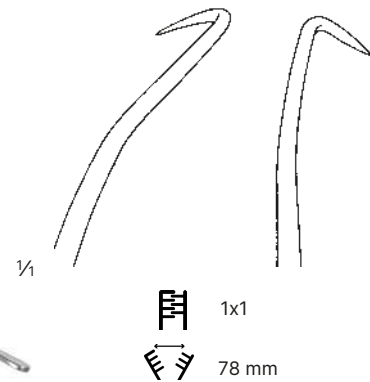

1/2

Gelpi
EK 469-19
18 cm / 7 1/8"

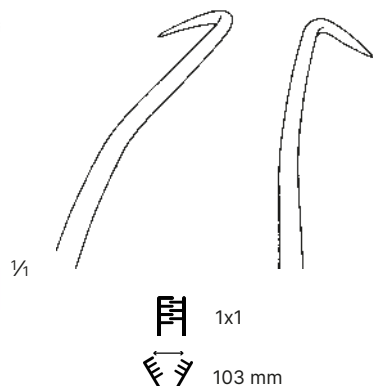

1/2

Gelpi
EK 470-19
18,5 cm / 7 2/8"

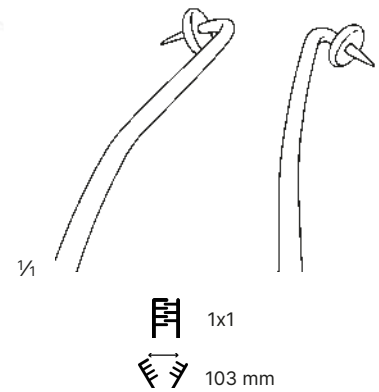



Spreading Instruments

Self Retaining Wound Retractors

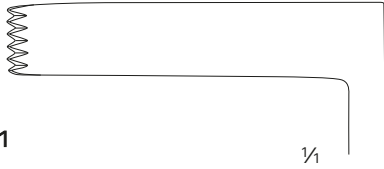

EK 471-01

50 x 10 mm
Left blade

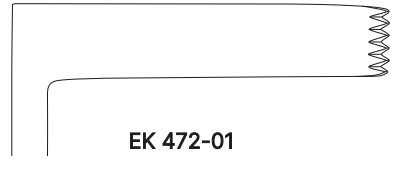

EK 472-01

50 x 10 mm
Blade rightfull



EK 471-02

60 x 10 mm
Blade left full

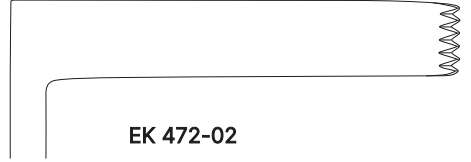

EK 472-02

60 x 10 mm
Blade rightfull

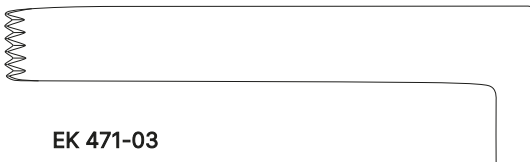

EK 471-03

70 x 10 mm
Blade left full

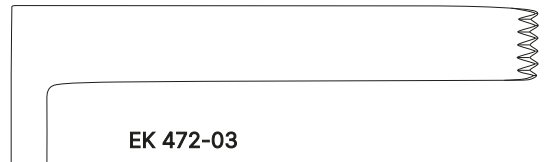

EK 472-03

70 x 10 mm
Blade rightfull



Meyerding

17 cm / 6 5/8"

 102 mm



1/2

Meyerding

18 cm / 7 1/8"

- EK 474-01** 32 x 25 mm
- EK 474-02** 54 x 25 mm
- EK 474-03** 60 x 19 mm
- EK 474-04** 60 x 25 mm



1/2

Plester

13 cm / 5 1/8"

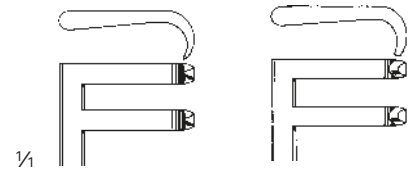

1/4

EK 475-13
sharp

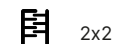

2x2



37 mm

EK 475-14
blunt



2x2



37 mm



1/2

Plester

EK 476-10

10,5 cm / 4 1/8"

blunt



37 mm

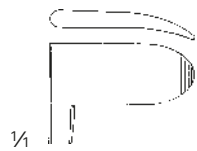

1/4



1/2

Plester

EK 477-10

10,5 cm / 4 1/8"

blunt



37 mm

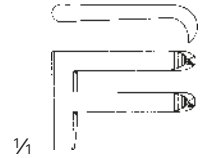

1/4



Spreading Instruments

Self Retaining Abdominal Retractors



1/2

Collin, Baby

EK 504-00

18 cm / 7 1/8" Length of retractor without blades

complete, with 2 pairs of lateral blades
ref. EK 511-01 (18 x 40 mm) and
EK 511-02 (27 x 40 mm)



60 mm



1/2

Collin

EK 505-00

20 cm / 7 7/8" Length of retractor without blades

complete, with 1 pair of lateral blades
ref EK 511-03 (38x60 mm)



80 mm



1/2

Collin

EK 506-00

20 cm / 7 7/8"

complete (spreader and central blade 38x55 mm), with 1 pair of lateral blades ref. EK 511-03 (38 x 60 mm)



100 mm

Collin

EK 507-00

20 cm / 7 7/8"

complete (spreader and central blade 50x75 mm), with 1 pair of lateral blades ref. EK 511-04 (45 x 80 mm)



100 mm



Spreading Instruments

Self Retaining Abdominal Retractors



1/2

Collin

EK 508-00

31 cm / 12 2/8" Length of retractor without blade

Complete spreader and central blade 60x75 mm
1 pair of lateral blades ref. E 511-05 60 x 80 mm

 140 mm



1/2

Ricard

EK 509-00

complete (spreader and central blade (55x70 mm)
with 1 pair of lateral blades ref. EK 511-07

 250 mm

Ricard

EK 510-00

complete (spreader and central blade (80x90 mm) with
1 pair of lateral blades ref. EK 511-09

 220 mm



Spreading Instruments

Retractor Blades



1/2

EK 511-01- EK 511-05
blades for abdominal retractors (pair)



- EK 504-00
- EK 505-00
- EK 506-00
- EK 507-00
- EK 508-00
- EK 509-00
- EK 510-00



18 x 40 mm
EK 511-01

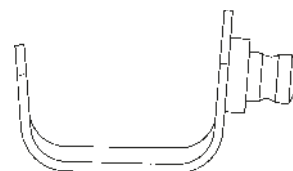

27 x 40 mm
EK 511-02



38 x 60 mm
EK 511-03

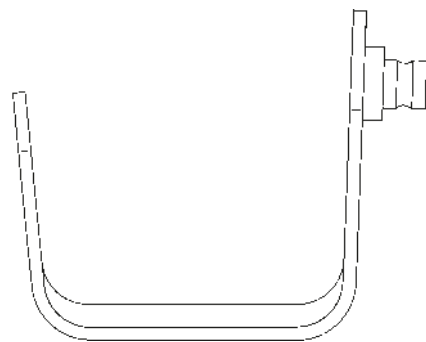

45 x 80 mm
EK 511-04

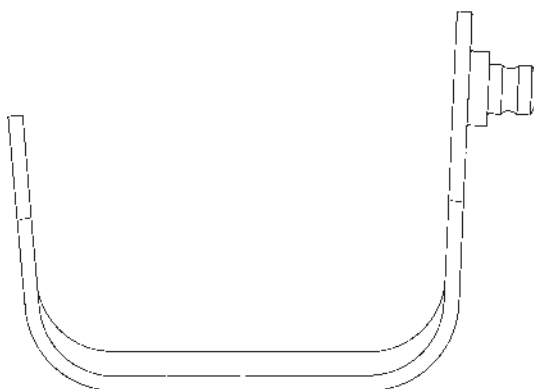

60 x 80 mm
EK 511-05



EK 511-06- EK 511-11

blade for abdominal retractors (pair)



EK 504-00

EK 505-00

EK 506-00

EK 507-00

EK 508-00

EK 509-00

EK 510-00

1/2

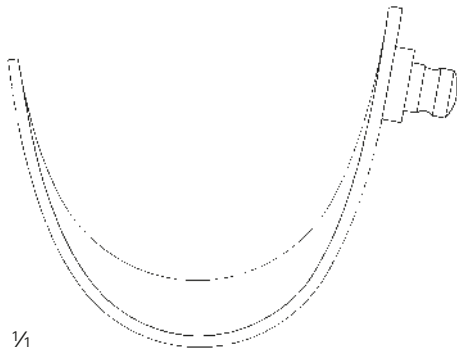

1/4

50 x 70 mm

EK 511-06

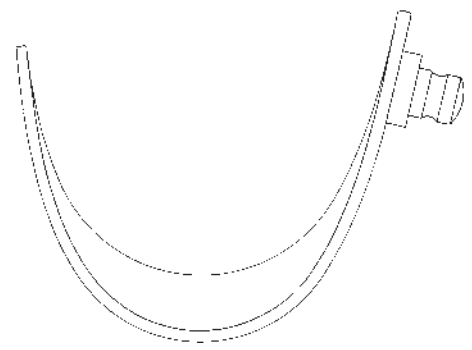

50 x 58 mm

EK 511-07

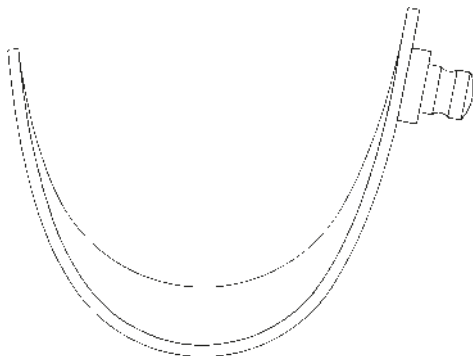

52 x 110 mm

EK 511-08

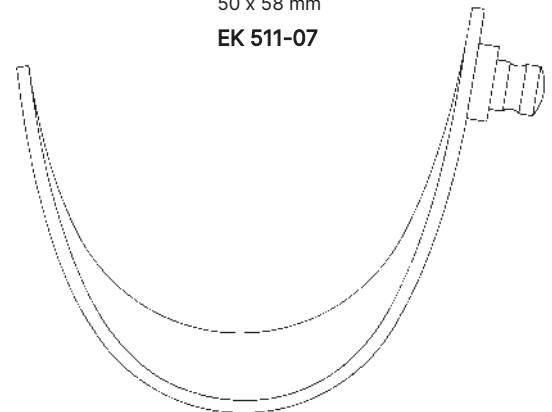

60 x 80 mm

EK 511-09

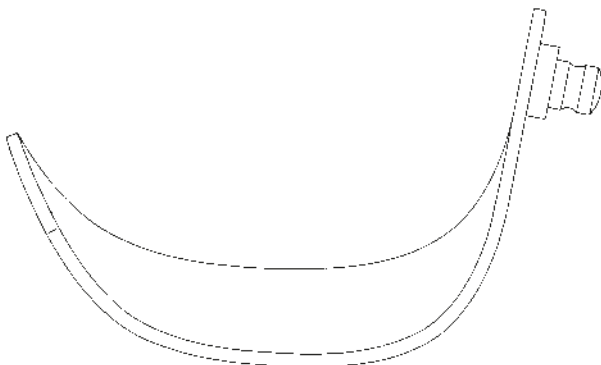

70 x 55 mm

EK 511-10

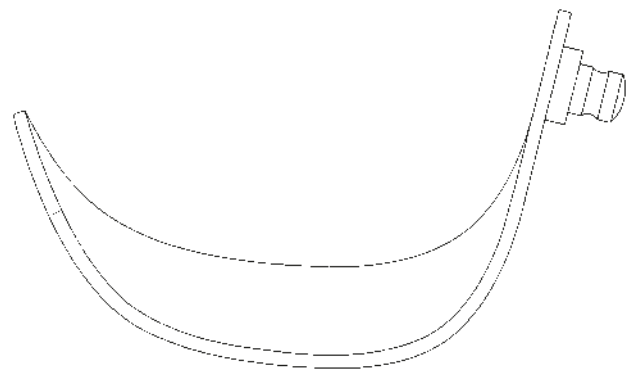

72 x 85 mm

EK 511-11

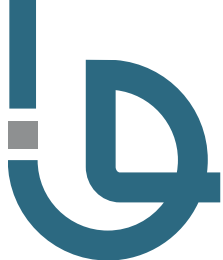

Spreading Instruments

Self Retaining Abdominal Retractors

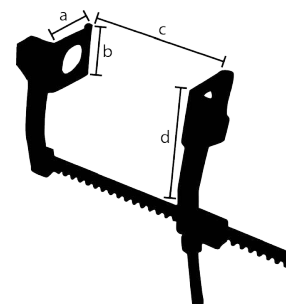

1/2

Gosset-Baby

| | a x b | c | d |
|------------------|-----------|-------|-------|
| EK 485-10 | 45 x 30mm | 120mm | 125mm |

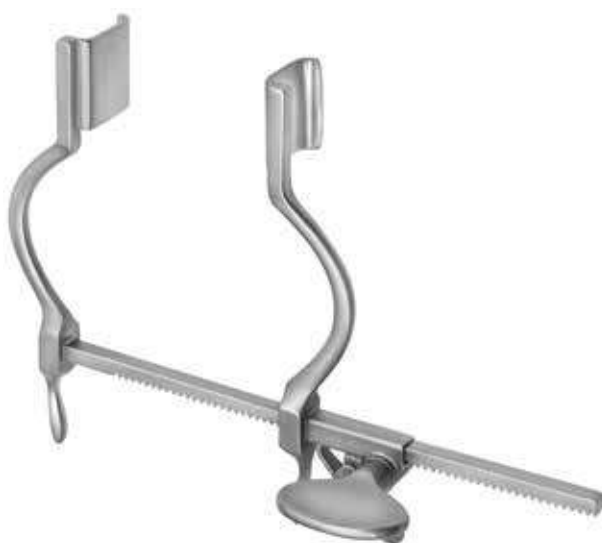

1/2

Hertzler

| | a x b | c | d |
|------------------|-----------|-------|------|
| KA 608-01 | 20 x 25mm | 105mm | 90mm |

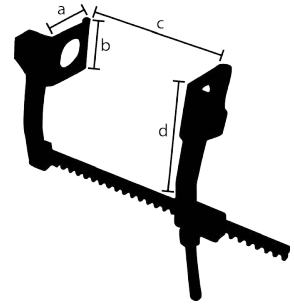

Gosset

| | a x b | c | d |
|------------------|-----------|-------|------|
| EK 487-14 | 63 x 35mm | 140mm | 85mm |



Balfour-Baby

| | a x b | c | d |
|------------------|-----------|------|-------|
| EK 490-09 | 30 x 20mm | 80mm | 125mm |
| central blade | 24x20mm | | |



Spreading Instruments

Self Retaining Abdominal Retractors

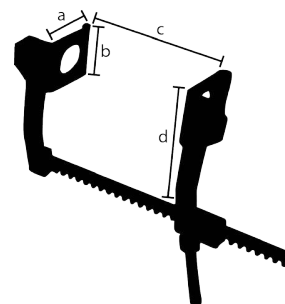

1/2

Gosset

| | a x b | c | d |
|------------------|-----------|-------|-------|
| EK 488-16 | 63 x 35mm | 160mm | 165mm |
| central blade | 60 x 65mm | | |

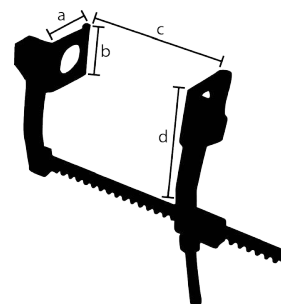

1/2

Balfour

complete, with 1 pair of lateral blades (70 x 35 mm)
and central blade (45 x 80 mm)

| | a x b | c | d |
|------------------|-----------|-------|-------|
| EK 491-18 | 70 x 35mm | 160mm | 230mm |

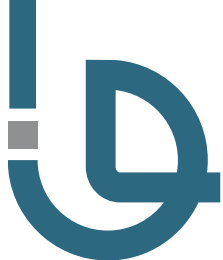

Spreading Instruments

Self Retaining Abdominal Retractors

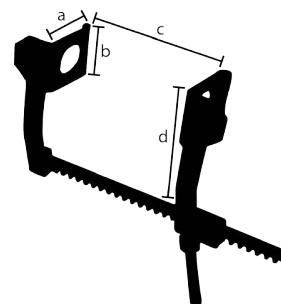

$\frac{1}{2}$

Balfour

complete, with 1 pair of lateral blades (100 x 35 mm)
and central blade ref. EK 492-02 (100 x 60 mm)

| | a x b | c | d |
|------------------|------------|-------|-------|
| EK 491-20 | 100 x 35mm | 180mm | 240mm |

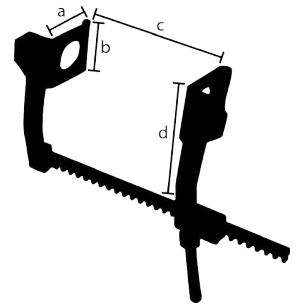

1/2

Balfour

complete, with 1 pair of lateral blades (100 x 35 mm)
and central blade ref. EK 493-02 (68 x 85 mm)

| | a x b | c | d |
|------------------|------------|-------|-------|
| EK 491-25 | 100 x 35mm | 230mm | 300mm |



Spreading Instruments

Self Retaining Abdominal Retractors



1/2

Balfour

| | | a x b | c | d |
|---------------|------------------|-----------|-------|-------|
| Complete | EK 489-00 | | 190mm | 250mm |
| Central Blade | EK 493-02 | 68 x 85mm | | |

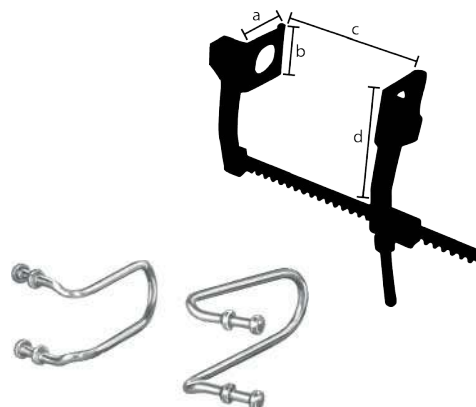

EK 489-01
Fenestrated Blades (pair)
60 x 30 mm



EK 489-00



EK 489-02
Fenestrated Blades (pair)
80 x 30 mm



EK 489-00



- EK 491-18
- EK 491-20
- EK 491-25
- EK 489-00



1/2

Balfour

EK 492-01

100 x 70 mm

EK 492-02

100 x 60 mm



1/2

Balfour

EK 493-01

45 x 80 mm

EK 493-02

68 x 85 mm

EK 493-03

40 x 68 mm



Spreading Instruments

Self Retaining Abdominal Retractor Frames



Kirschner

EK 497-00

Internal dimensions

300 x 240 mm



Kirschner

EK 498-00

Internal dimensions

240 x 240 mm



EK 497-00
EK 498-00

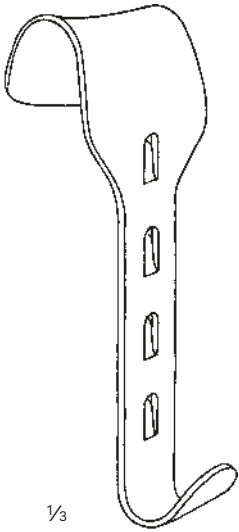

1/3

EK 499-01
40 x 55 mm

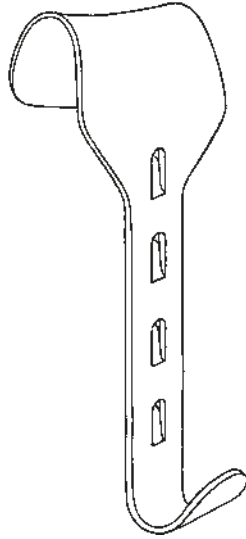

EK 499-02
50 x 65 mm

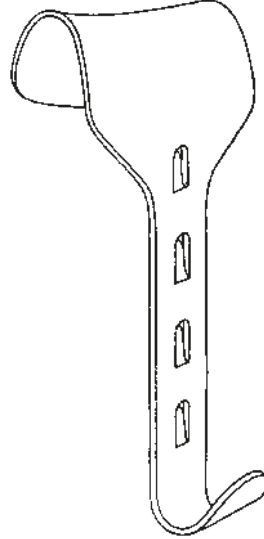

EK 499-03
60 x 85 mm

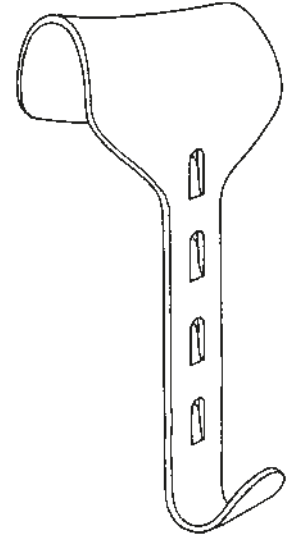

EK 499-04
78 x 65 mm

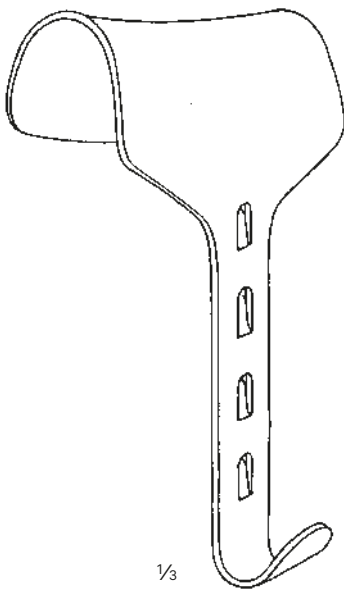

1/3

EK 499-05
85 x 90 mm

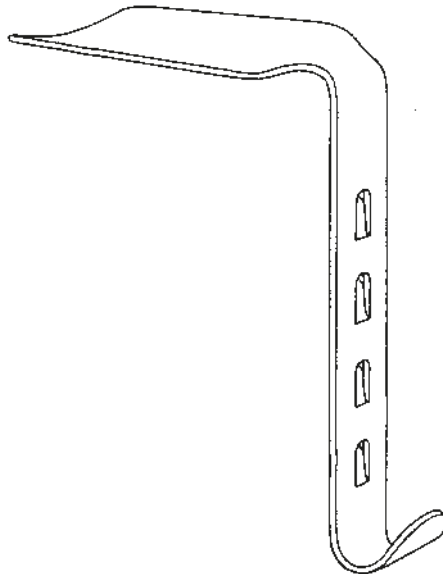

EK 499-06
98 x 50 mm

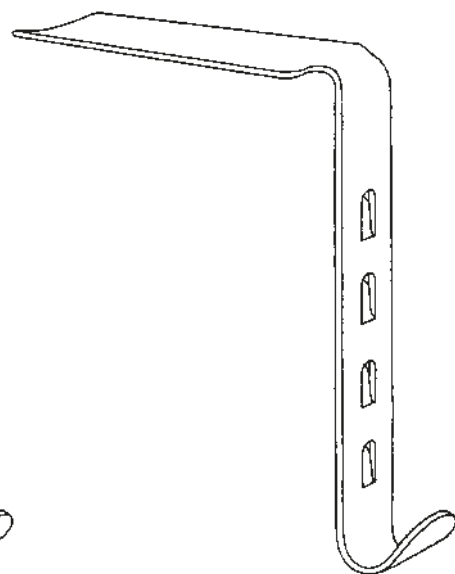

EK 499-07
105 x 35 mm



Spreading Instruments

Self Retaining Abdominal Retractors, Central Blades



O'Sullivan-O'Connor

EK 495-02

80 x 45 mm

EK 495-03

110 x 70 mm

1/2

O'Sullivan-O'Connor
EK 495-01

20 cm / 7 7/8"
complete, with 2 fixed lateral blades (60 x 35 mm)
and 2 central blades ref. EK 495-02 (80 x 45 mm) and EK 495-03 (110 x 70 mm)

 190 mm

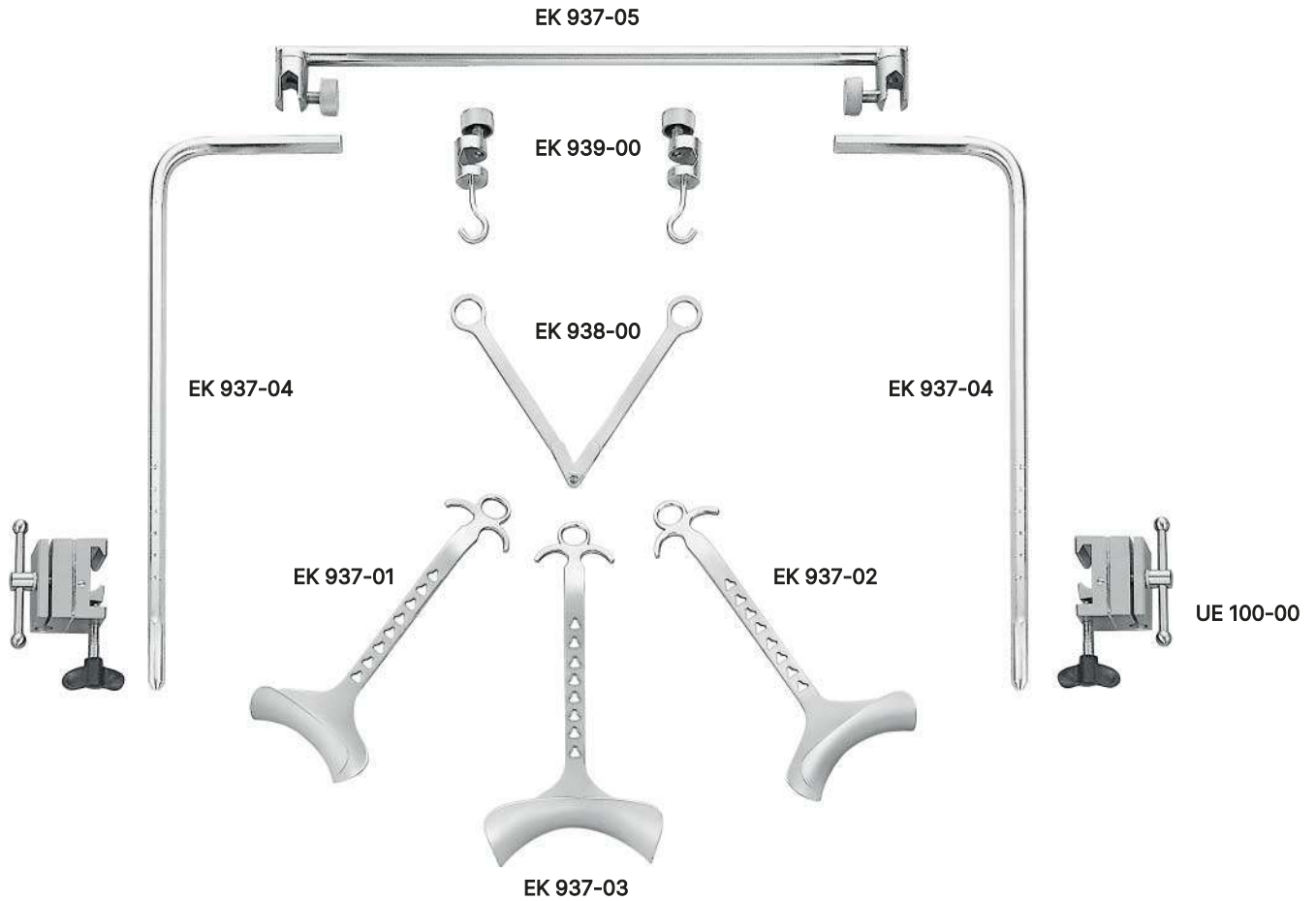

Rochard
EK 940-00
Retractor System

complete consisting of:

| | |
|-----------|--------------------------------|
| UE 100-00 | 2 Rail Clamp |
| EK 937-04 | 2 Lateral Holding Bar |
| EK 937-05 | 2 Cross Bar |
| EK 939-00 | 2 Sliding holder |
| EK 938-00 | 2 Fixing device for blades |
| EK 937-01 | 2 Retractor Blade, 50 x 105 mm |
| EK 937-02 | 2 Retractor Blade, 50 x 120 mm |
| EK 937-03 | 2 Retractor Blade 50 x 160 mm |

Abdominal, Intestinal and Rectal Instruments

Intestinal and Tissue
Grasping Clamps
Intestinal Clamps
Intestinal Clamps
Pylorus Spreader
Sigmoid Anastomosis Clamps
Rectal Speculums
Rectal Spreaders
Anuscope Sphincteroscopes
Hemoroidal Clamps





Abdominal, Intestinal and Rectal Instruments

Intestinal and Tissue Grasping Clamps

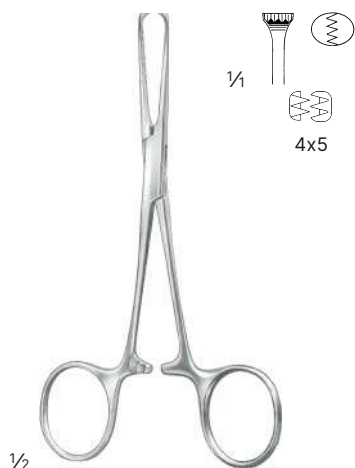

Allis-Baby
HM 400-13
13 cm / 5 1/8"



Allis

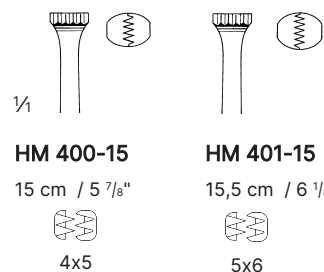

HM 400-15
15 cm / 5 7/8"
4x5



HM 401-15
15,5 cm / 6 1/8"
5x6

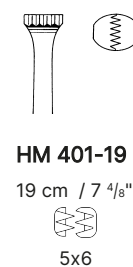

HM 401-19
19 cm / 7 4/8"
5x6

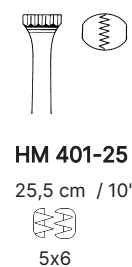

HM 401-25
25,5 cm / 10"
5x6

Atraumatic



Allis

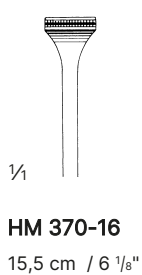

HM 370-16
15,5 cm / 6 1/8"

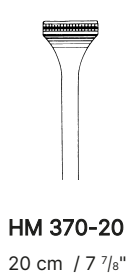

HM 370-20
20 cm / 7 7/8"

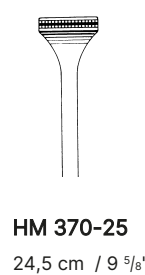

HM 370-25
24,5 cm / 9 5/8"

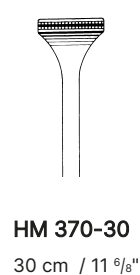

HM 370-30
30 cm / 11 6/8"



1/2

Judd-Allis

1/4



HM 390-15

15,5 cm / 6 1/8"



3x4



HM 390-25

19 cm / 7 4/8"



3x4



1/2

Allis

HM 400-19

19 cm / 7 4/8"

1/4



5x6



1/2

Thoms-Allis

HM 390-20

20,5 cm / 8 1/8"

1/4



6x7

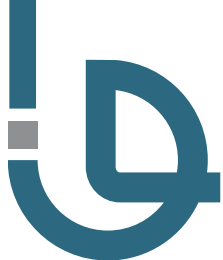

Abdominal, Intestinal and Rectal Instruments

Intestinal and Tissue Grasping Clamps

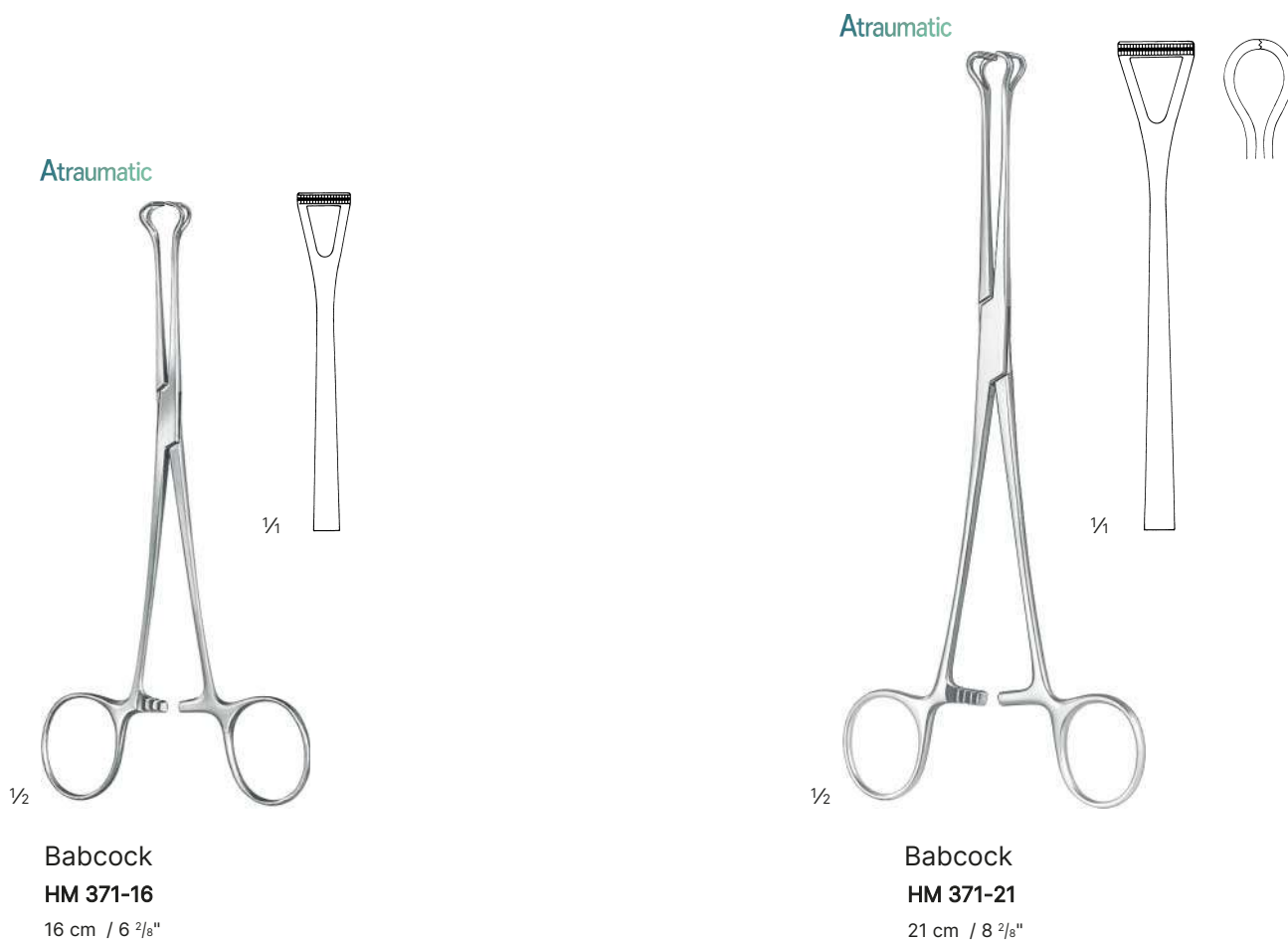
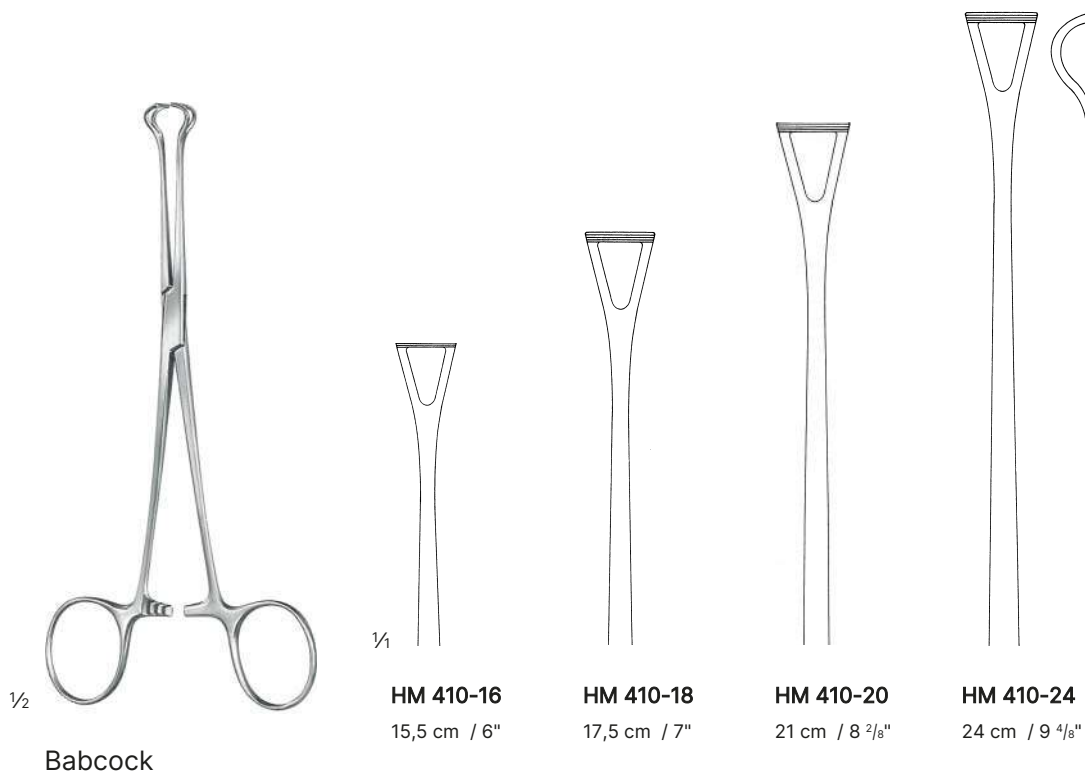



HM 353-19
18 cm / 7 1/8"

1/4

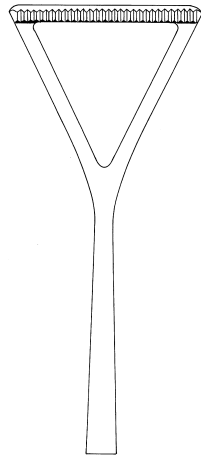
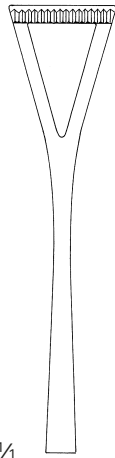

HM 354-20
20,5 cm / 8 1/8"

HM 355-23
23 cm / 9"

Atraumatic



1/4

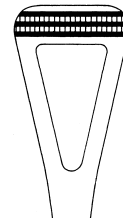

HM 372-19
20,5 cm / 8 1/8"
medium

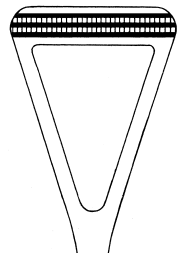

HM 372-23
23 cm / 9"
wide



HM 421-15
15,5 cm / 6 1/8"

1/4

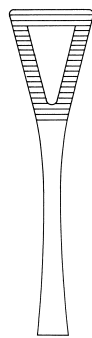

HM 421-20
21 cm / 8 2/8"

1/2

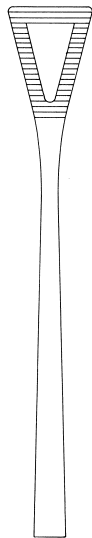

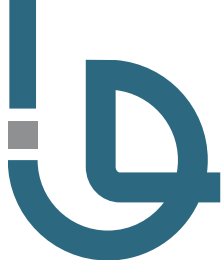

Abdominal, Intestinal and Rectal Instruments

Intestinal Clamps



1/2

Bainbridge

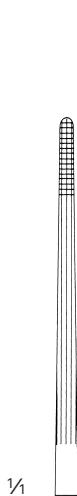

1/1

HM 442-15

15 cm / 6 "



HM 442-18

18,5 cm / 7 1/8"



HM 443-15

15 cm / 6 "



HM 443-18

18,5 cm / 7 1/8"



1/2

Doyen



1/1

HM 568-01

23,5 cm / 9 2/8"

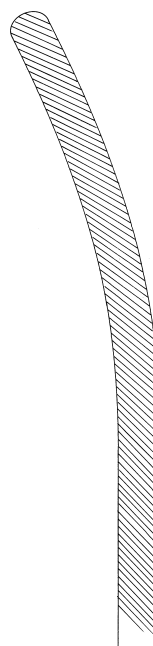

HM 568-02

23 cm / 9"

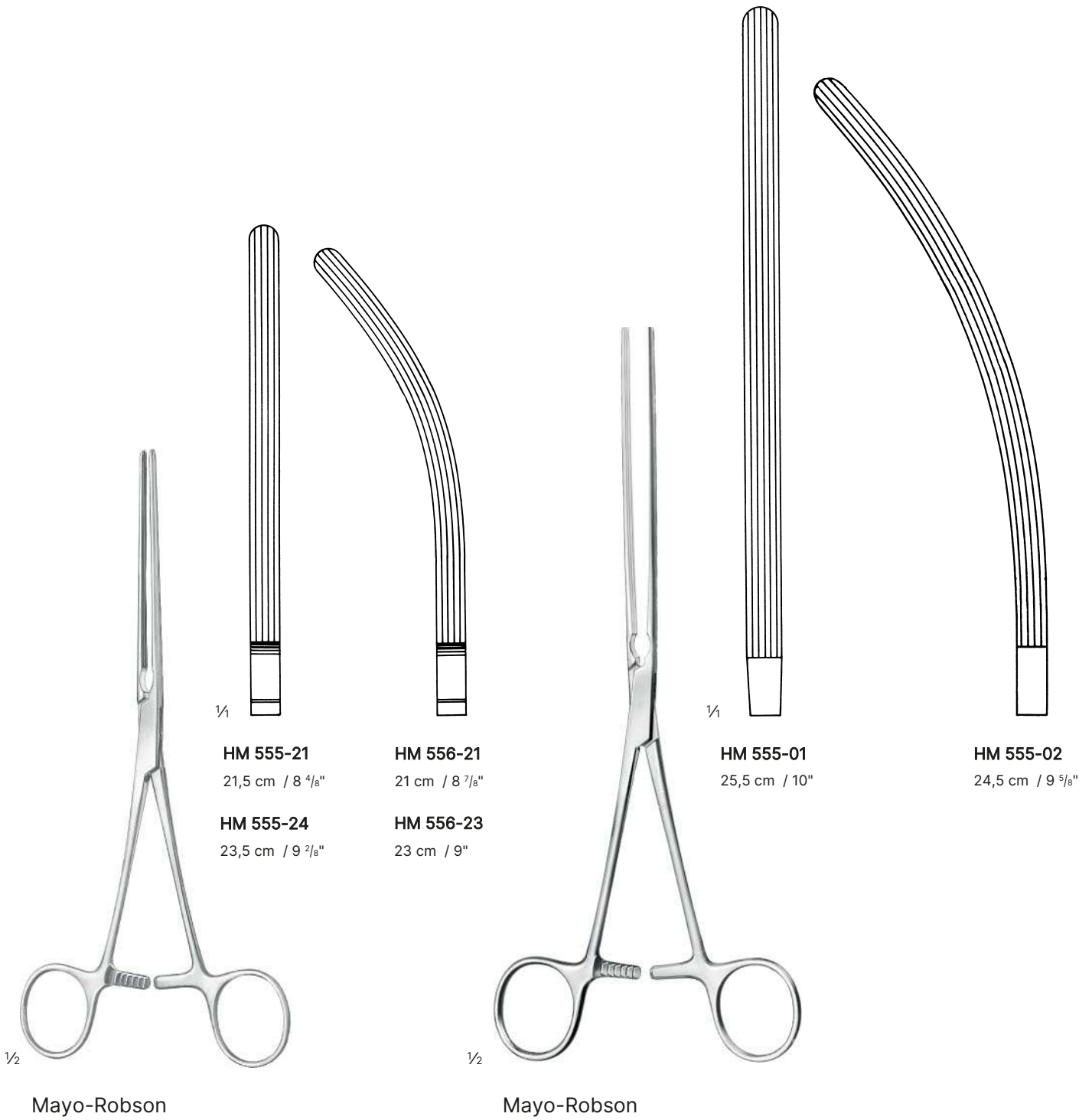



Atraumatic



Mayo-Robson

KA 322-01

26 cm / 10 2/8"

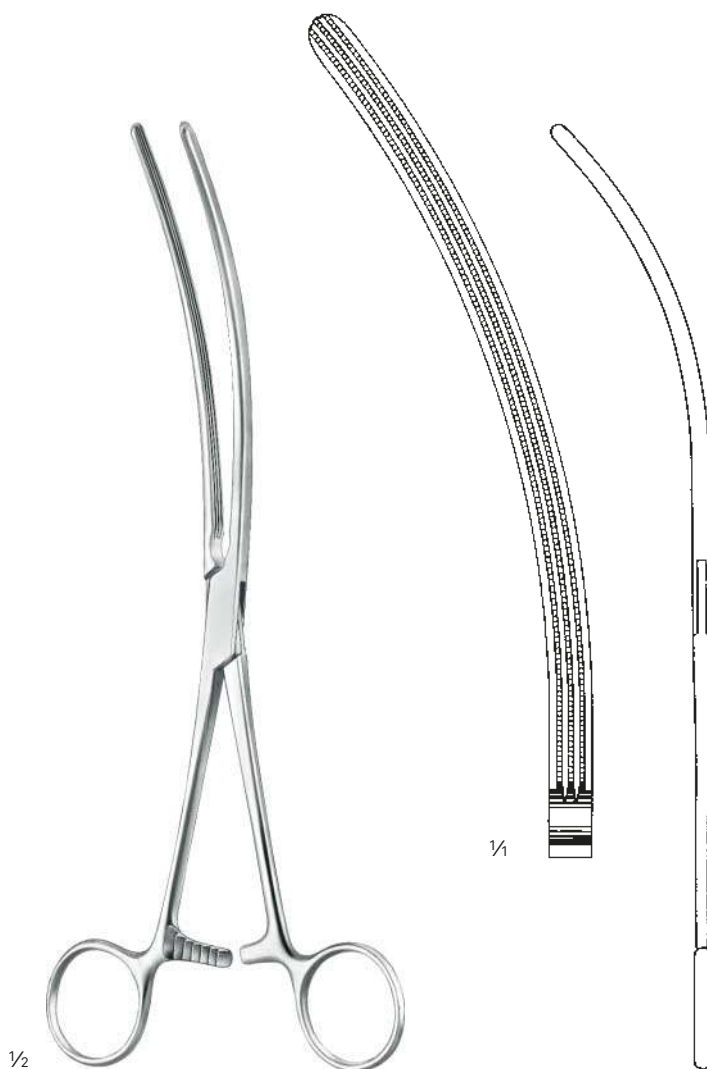

Mayo-Robson

KA 322-02

25 cm / 9 2/8"

Atraumatic



1/2

Kocher

1/4

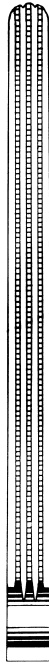

KA 320-22

22,5 cm / 8 6/8"

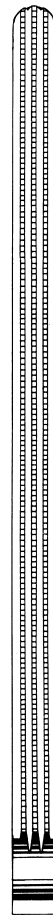

KA 320-25

25 cm / 9 7/8"

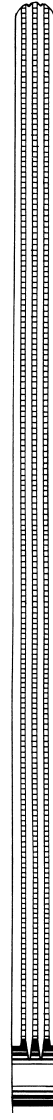

KA 320-28

28 cm / 11"



1/2

Kocher

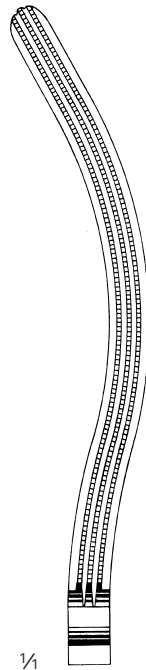
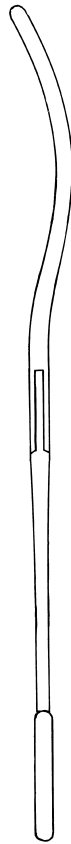

1/4

KA 321-22
22 cm / 8 5/8"

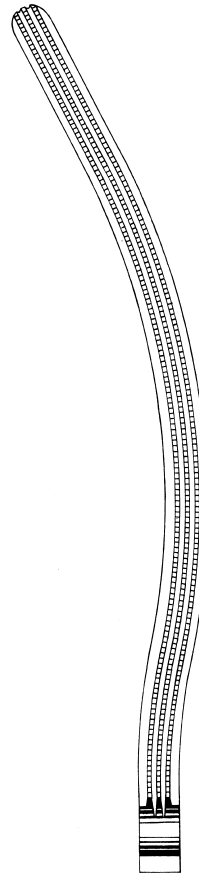

KA 321-25
24,5 cm / 9 5/8"

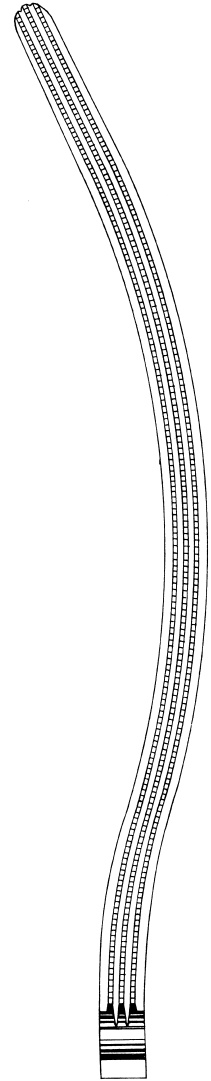

KA 321-28
27 cm / 10 5/8"



1/2

Benson
KA 340-15
15,5 cm / 6 1/8"
Pylorus Spreader



1/2

Payr
with pin

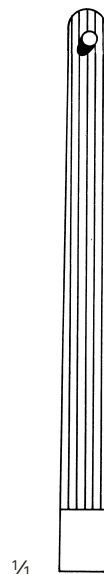

1/4

KA 410-20
21 cm / 8 2/8"

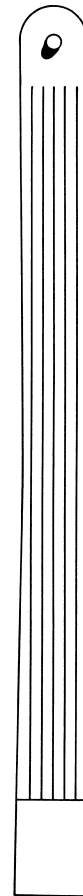

KA 410-27
29 cm / 11 3/8"

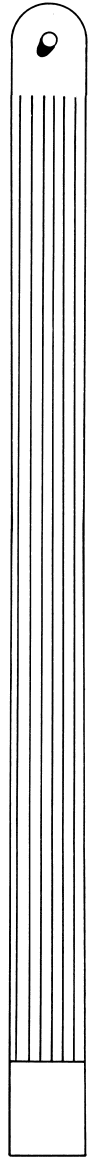

KA 411-35
34 cm / 13 3/8"

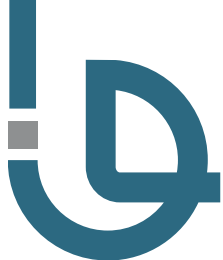

Abdominal, Intestinal and Rectal Instruments

Sigmoid Anastomosis Clamps

Atraumatic



2x3



1/1

KA 465-18

18,5 cm / 7 2/8"

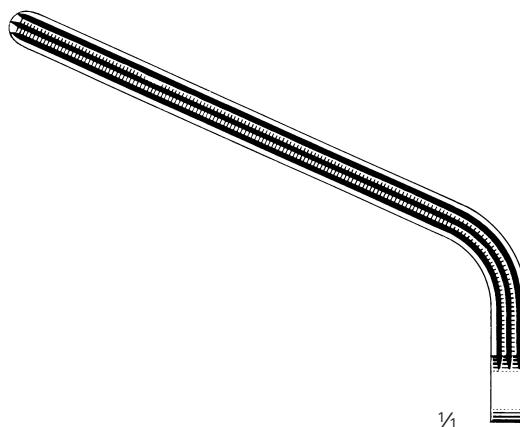

1/1

KA 465-20

20 cm / 8"

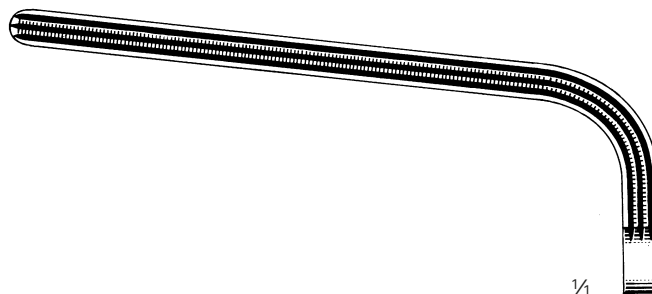

1/1

KA 465-25

26 cm / 10 2/8"



1/2

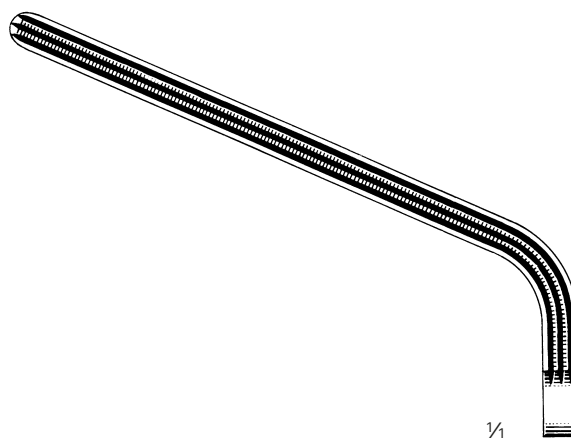
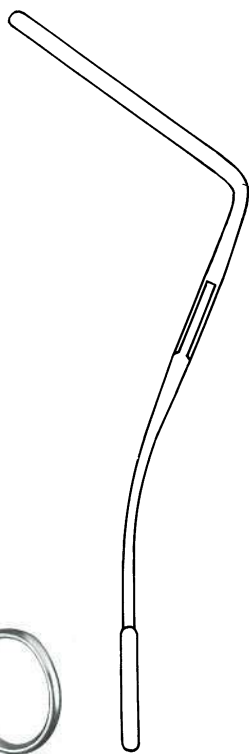

1/1

KA 465-26

27,5 cm / 10 7/8"

Morris-De Bakey



105 x 23 mm

1/2

Czeryn
SP 104-22
22,5 cm / 8 7/8"



70 x 15 mm

1/2

Sims
SP 110-16
16 cm / 6 2/8"



80 x 25 mm

1/2

Pratt
SP 102-20
20,5 cm / 8 1/8"



95 x 15 mm

Mathieu
SP 103-21

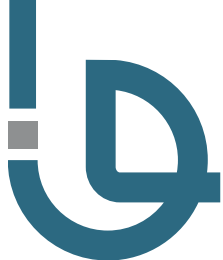

1/2

Ives-Fansler

SP 106-14

Ø22 mm

Rectal Spreaders

working length

80 mm



1/2

Kelly

SP 107-21

Ø21 mm

working length

50 mm

SP 107-27

Ø27 mm

working length

50 mm

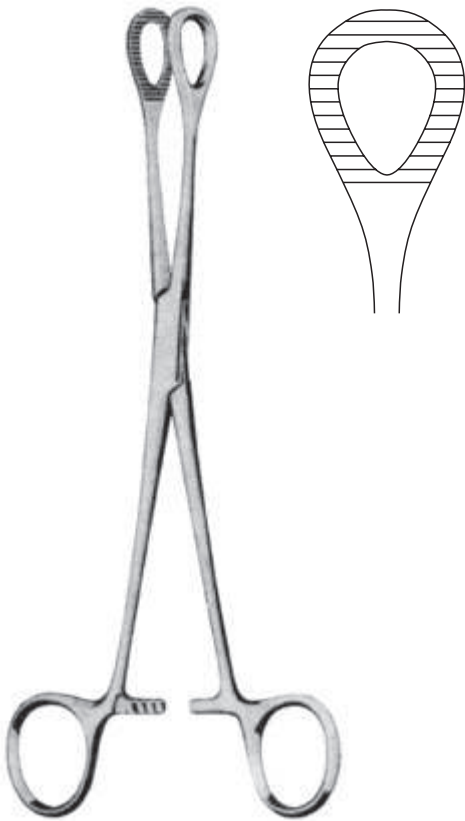

Heywood-Smith
CM 219-21
21 cm / 8 1/4"

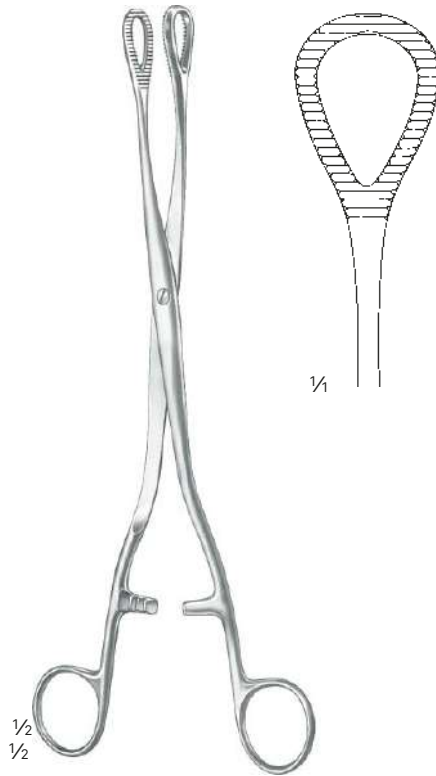

Heywood-Smith
CM 220-21
20 cm / 7 7/8"

Atraumatic



CM 250-25
25 cm / 9 7/8"

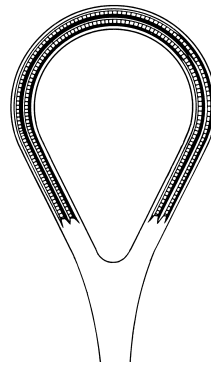

CM 250-27
27 cm / 10 5/8"

Urology Instruments

Gall Duct Dilators
Kidney Pedicle Clamps
Bladder Retractors
Penis Clamp
Foreign Body Forceps
Catheter Guide
Urethral Bougies



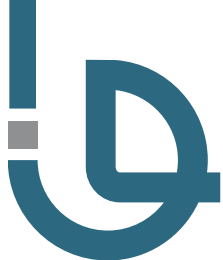

Fig. 1
Ø 1,0 mm
SP 210-01



Fig. 2
Ø 2,0 mm
SP 210-02



Fig. 3
Ø 3,0 mm
SP 210-03



Fig. 4
Ø 4,0 mm
SP 210-04



Fig. 5
Ø 5,0 mm
SP 210-05



Fig. 6
Ø 6,0 mm
SP 210-06



Fig. 7
Ø 7,0 mm
SP 210-07



Fig. 8
Ø 8,0 mm
SP 210-08

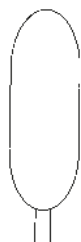

Fig. 9
Ø 9,0 mm
SP 210-09



Fig. 10
Ø 10 mm
SP 210-10



Fig. 11
Ø 11 mm
SP 210-11



Fig. 12
Ø 12 mm
SP 210-12



Fig. 13
Ø 13 mm
SP 210-13



Bakes

31,5 cm / 12 3/8"
malleable shaft



Guyon

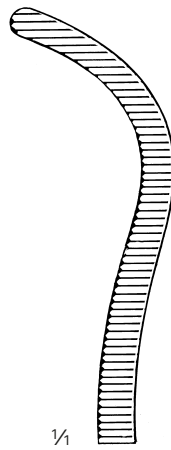

HM 543-20
19,5 cm / 7 ⁵/₈"

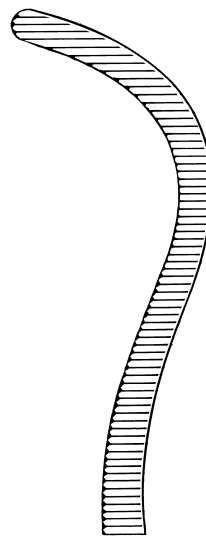

HM 543-22
21,5 cm / 8 ⁴/₈"

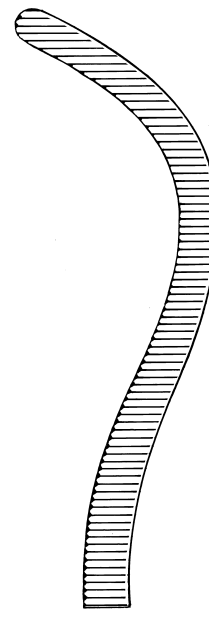

HM 543-24
24,5 cm / 9 ⁵/₈"

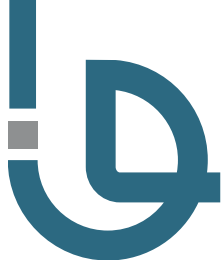

1/2

Wertheim
HM 561-25
26 cm / 10 2/8"

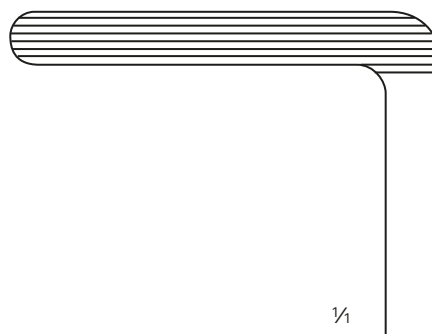

1/4



1/2

Wertheim-Cullen
HM 585-21
21 cm / 8 2/8"



1/2

Millin

EK 650-00

complete, with 2 pairs of lateral blades 57 x 25 mm and 82 x 25 mm, and 1 central blade 105 x 45 mm

EK 650-01

Spreader only



57 x 25 mm

EK 650-02

Lateral Blades



82 x 25 mm

EK 650-03

Lateral Blades

105 x 45 mm

EK 650-04

Central Blade



Urology Instruments

Penis Clamp, Foreign Body Forceps



1/2

Strauss
SP 450-13

11 cm / 4 3/8"

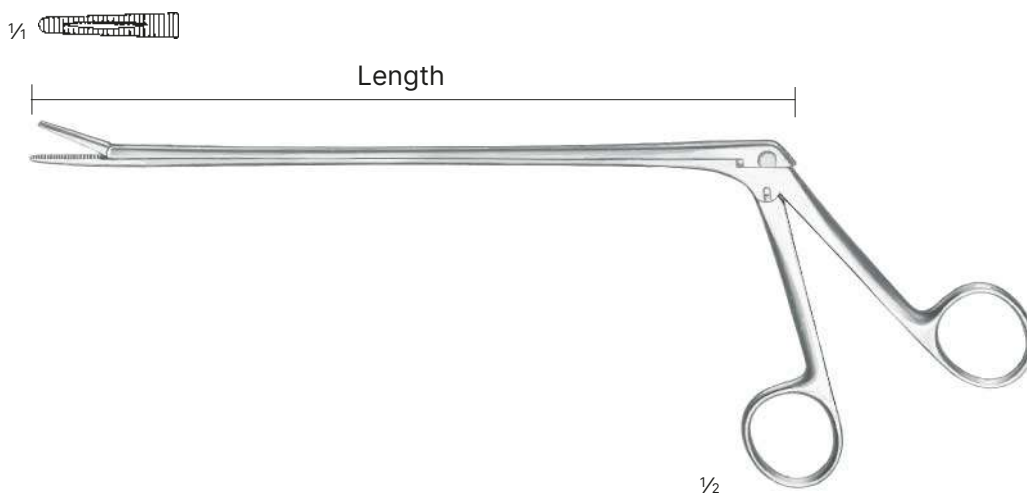

1/4

Length

1/2

Mathieu
RG 510-20

Length: 200 mm

Mathieu
RG 510-28

Length: 280 mm



SO 100-15

36,5 cm



SO 110-15

46,5 cm



Urology Instruments

Urethral Bougies

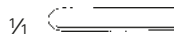

1/2

Van Buren

27 cm / 10 5/8"

| French(F) | Van Buren |
|-----------|-----------|
| 8 | SP 200-08 |
| 10 | SP 200-10 |
| 12 | SP 200-12 |
| 14 | SP 200-14 |
| 16 | SP 200-16 |
| 18 | SP 200-18 |
| 20 | SP 200-20 |
| 22 | SP 200-22 |
| 24 | SP 200-24 |
| 26 | SP 200-26 |
| 28 | SP 200-28 |
| 30 | SP 200-30 |

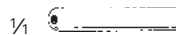

1/2

Guyon

26,5 cm / 10 3/8"

| French(F) | Guyon |
|-----------|-----------|
| 10 | SP 200-09 |
| 12 | SP 200-11 |
| 14 | SP 200-13 |
| 16 | SP 200-15 |
| 18 | SP 200-17 |
| 20 | SP 200-19 |
| 22 | SP 200-21 |
| 24 | SP 200-23 |
| 26 | SP 200-25 |
| 28 | SP 200-27 |
| 30 | SP 200-29 |

Gynecology and Obstetric Instruments

Vaginal Speculums
Vaginal Retractors
Vaginal Speculum Blades
Self Retaining Vaginal Retractors
Uterine Dilators
Endocervical Speculum
Uterine Probes
Uterine Tenaculum Forceps
Uterine Dressing Clamps
Uterine Polypus and Ovum Forceps
Myoma Screws
Biopsy Forceps
Uterine Canulla
Umbilical Scissors
Episiotomy Scissors
Obstetrical Forceps
Placenta and Ovum Forceps



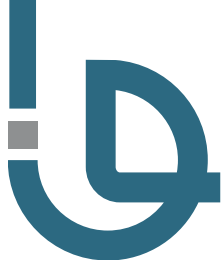

1/2

Collin

| | |
|------------------|-------------|
| SP 250-32 | 85 x 30 mm |
| SP 250-35 | 100 x 35 mm |
| SP 250-40 | 110 x 40 mm |



1/2

CUSCO

| | |
|------------------|-------------|
| SP 255-25 | 90 x 22 mm |
| SP 255-27 | 100 x 25 mm |
| SP 255-30 | 105 x 27 mm |



1/2

Cusco

| | |
|------------------|------------|
| SP 255-00 | 75 x 18 mm |
|------------------|------------|



1/2

Cusco

| | |
|------------------|-------------|
| SP 256-01 | 75 x 32 mm |
| SP 256-02 | 85 x 37 mm |
| SP 256-03 | 100 x 35 mm |



1/2

Cusco

- SP 258-32** 75 x 34 mm
- SP 258-36** 85 x 37 mm
- SP 258-37** 100 x 37 mm



1/2

Trelat

- SP 260-33** 85 x 33 mm
- SP 260-35** 95 x 35 mm
- SP 260-43** 115 x 43 mm



1/2

Grave

- SP 265-20** 75 x 20 mm
- SP 265-30** 95 x 35 mm
- SP 265-33** 115 x 35 mm



1/2

Pederson

- SP 270-22** 100 x 24 mm
- SP 270-25** 120 x 26 mm



1/2

Sims

| | |
|------------------|-------------------------|
| SP 285-01 | 65 x 20 mm / 70 x 30 mm |
| SP 285-02 | 70 x 30 mm / 80 x 35 mm |
| SP 285-03 | 85 x 35 mm / 90 x 40 mm |



SP 287-18

Fig.1

105 x 18 mm

SP 287-20

Fig.2

105 x 21 mm

1/2

Kristeller



SP 287-14

Fig.1

110 x 14 mm

SP 287-16

Fig.2

110 x 17 mm

1/2

Kristeller



SP 286-18

Fig.1 (SP 287-18 & SP 287-14)

SP 286-20

Fig.2 (SP 287-20 & SP 287-16)

1/2

Kristeller

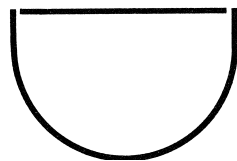
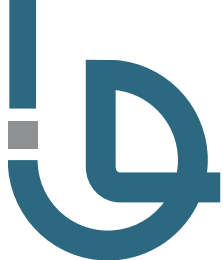

deep speculum



- SP 287-27 Fig.1 110 x 28 mm
- SP 287-30 Fig.2 110 x 30 mm
- SP 287-36 Fig.3 110 x 36 mm

- SP 287-23 Fig.1 115 x 23 mm
- SP 287-26 Fig.2 115 x 26 mm
- SP 287-32 Fig.3 115 x 32 mm

1/2

Kristeller

1/2

Kristeller



- SP 286-27 Fig.1 (SP 287-27 & SP 287-23)
- SP 286-30 Fig.2 (SP 287-26 & SP 287-30)
- SP 286-36 Fig.3 (SP 287-36 & SP 287-32)

1/2

Kristeller



1/2

Kallmogren

SP 295-01

90 x 38 mm



1/2

Kallmorgen

SP 291-17

75 x 39 mm

SP 291-20

95 x 39 mm



1/2

Doyen

| | |
|------------------|-------------|
| EK 265-35 | 58 x 35 mm |
| EK 266-35 | 88 x 35 mm |
| EK 267-35 | 118 x 35 mm |
| EK 265-45 | 60 x 47 mm |
| EK 266-45 | 95 x 47 mm |
| EK 267-45 | 20 x 47 mm |
| EK 268-45 | 165 x 47 mm |
| EK 265-60 | 55 x 60 mm |
| EK 266-60 | 85 x 60 mm |
| EK 267-60 | 115 x 60 mm |
| EK 268-60 | 160 x 60 mm |



Breisky

| | | |
|------------------|-------------|--|
| SP 276-20 | 100 x 20 mm | 29,5 cm / 11 ⁵ / ₈ " |
| SP 276-25 | 100 x 25 mm | 29,5 cm / 11 ⁵ / ₈ " |
| SP 276-30 | 100 x 30 mm | 29,5 cm / 11 ⁵ / ₈ " |
| SP 276-35 | 100 x 35 mm | 29,5 cm / 11 ⁵ / ₈ " |
| SP 276-40 | 100 x 40 mm | 29,5 cm / 11 ⁵ / ₈ " |
| SP 277-20 | 130 x 20 mm | 32 cm / 12 ⁵ / ₈ " |
| SP 277-25 | 130 x 25 mm | 32 cm / 12 ⁵ / ₈ " |
| SP 277-30 | 130 x 30 mm | 32 cm / 12 ⁵ / ₈ " |
| SP 277-35 | 130 x 35 mm | 32 cm / 12 ⁵ / ₈ " |
| SP 277-40 | 130 x 40 mm | 32 cm / 12 ⁵ / ₈ " |
| SP 278-40 | 160 x 40 mm | 35 cm / 13 ⁶ / ₈ " |
| SP 279-40 | 180 x 40 mm | 35 cm / 13 ⁶ / ₈ " |



110 x 27 mm
EK 358-25

$\frac{1}{4}$

115 x 22 mm
EK 360-22

115 x 28 mm
EK 360-27

$\frac{1}{4}$



$\frac{1}{2}$

Martin

26,5 cm / 10 $\frac{3}{8}$ "



$\frac{1}{2}$

Simon

28 cm / 11"



1/2

Auward
SP 302-75

23,5 cm / 9 2/8"

complete, with detachable weight

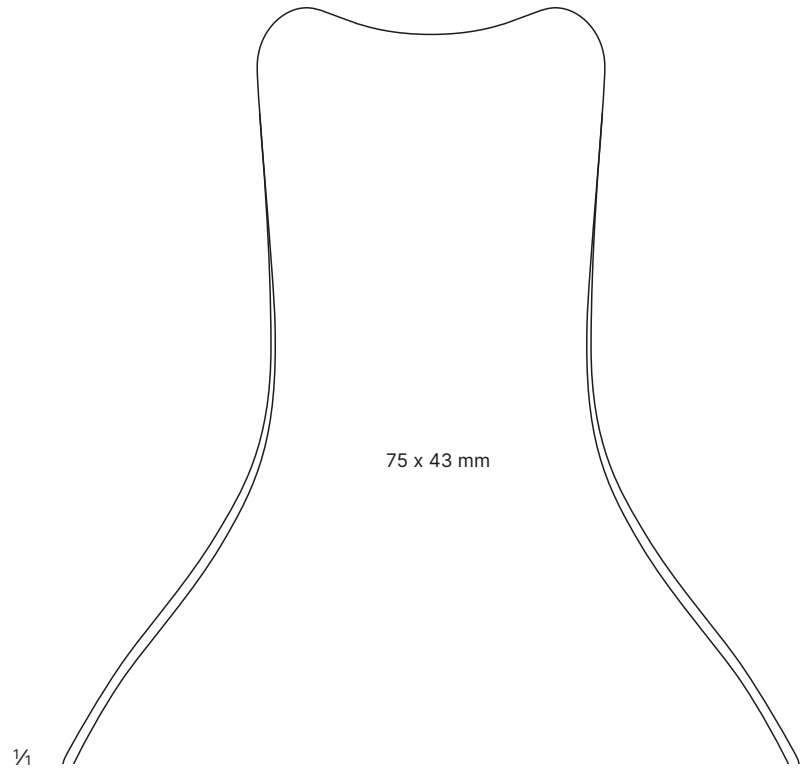

75 x 43 mm

1/1

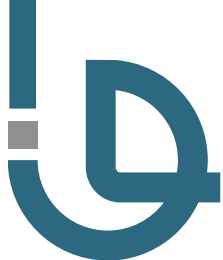

Scherbak

Specula Blade, only

1/4

80 x 30 mm
SP 400-20



SP 290-01

85 x 35 mm
SP 400-30



SP 290-01

90 x 40 mm
SP 400-36



SP 290-01



Scherbak

Specula Blade, only

1/4

58 x 40 - 60 mm
SP 290-35



SP 290-01

70 x 45 - 70 mm
SP 300-28



SP 290-01

**Scherbak
SP 290-00**

complete set with handle, weight (400 g), weight (800 g) and 5 blades



**Scherbak
SP 290-02**

10,5 cm / 4 " / 400 g

Weight for Vaginal Speculum



**Scherbak
SP 290-03**

13 cm / 5 " / 800 g

Weight for Vaginal Speculum



**Scherbak
SP 290-01**

20 cm / 7 7/8"

Handle for Vaginal Speculum

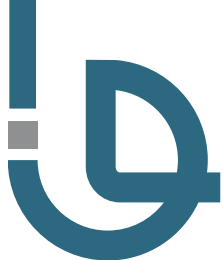

1/2

Joll
EK 467-14
15,5 cm / 6 1/8"
Thyroid and Vaginal retractor



1/2

Gelpi
EK 469-14
13 cm / 5 1/8"

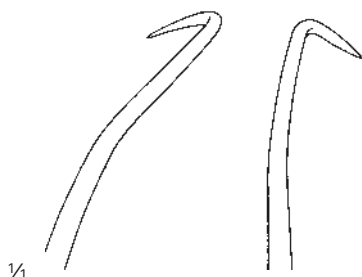

1/4

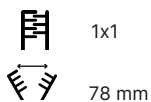

1x1

78 mm

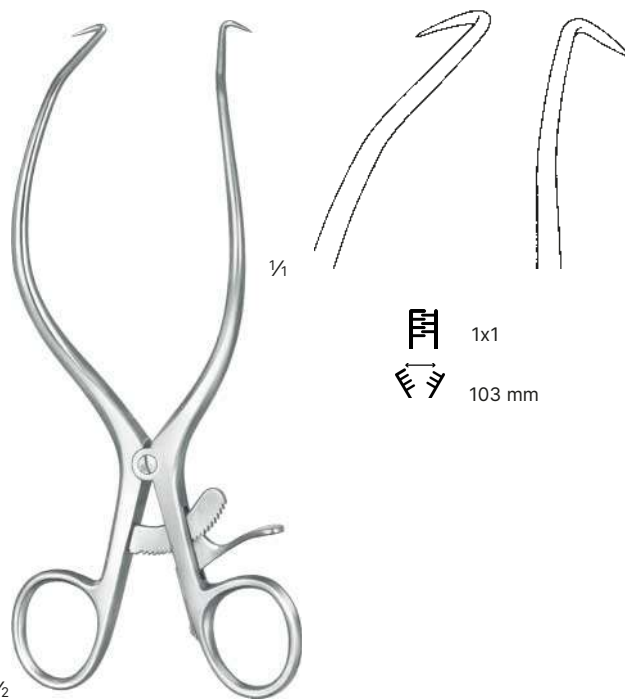

1/2

Gelpi
EK 469-19
18 cm / 7 1/8"

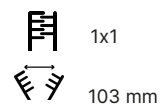

1x1

103 mm

mm Ø

| | | | |
|------|------------------|------|------------------|
| 1,0 | SP 500-01 | 12,0 | SP 500-12 |
| 1,5 | SP 501-01 | 12,5 | SP 501-12 |
| 2,0 | SP 500-02 | 13,0 | SP 500-13 |
| 2,5 | SP 501-02 | 13,5 | SP 501-13 |
| 3,0 | SP 500-03 | 14,0 | SP 500-14 |
| 3,5 | SP 501-03 | 14,5 | SP 501-14 |
| 4,0 | SP 500-04 | 15,0 | SP 500-15 |
| 4,5 | SP 501-04 | 15,5 | SP 501-15 |
| 5,0 | SP 500-05 | 16,0 | SP 500-16 |
| 5,5 | SP 501-05 | 16,5 | SP 501-16 |
| 6,0 | SP 500-06 | 17,0 | SP 500-17 |
| 6,5 | SP 501-06 | 17,5 | SP 501-17 |
| 7,0 | SP 500-07 | 18,0 | SP 500-18 |
| 7,5 | SP 501-07 | 19,0 | SP 500-19 |
| 8,0 | SP 500-08 | 20,0 | SP 500-20 |
| 8,5 | SP 501-08 | 21,0 | SP 500-21 |
| 9,0 | SP 500-09 | 22,0 | SP 500-22 |
| 9,5 | SP 501-09 | 23,0 | SP 500-23 |
| 10,0 | SP 500-10 | 24,0 | SP 500-24 |
| 10,5 | SP 501-10 | 25,0 | SP 500-25 |
| 11,0 | SP 500-11 | 26,0 | SP 500-26 |
| 11,5 | SP 501-11 | | |



1/2

Hegar

18,5 cm / 7 2/8"

mm Ø

| | |
|-------------|------------------|
| 1,0 / 2,0 | SP 506-02 |
| 3,0 / 4,0 | SP 506-04 |
| 5,0 / 6,0 | SP 506-06 |
| 7,0 / 8,0 | SP 506-08 |
| 9,0 / 10,0 | SP 506-10 |
| 11,0 / 12,0 | SP 506-12 |
| 13,0 / 14,0 | SP 506-14 |
| 15,0 / 16,0 | SP 506-16 |
| 17,0 / 18,0 | SP 506-18 |



1/2

Hegar

20,5 cm / 8 1/8"

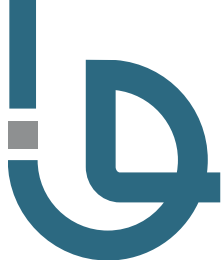

1/2

Kogan
SP 101-24
24,5 cm / 9 5/8"

Ø 4 mm



1/2

Sims
SO 601-33
33 cm / 13"
rigid

Ø 4 mm



1/2

Sims
SO 602-33
33 cm / 13"
malleable



Gynecology and Obstetric Instruments

Uterine Tenaculum Forceps, Uterine Dressing Clamps



1/2

Braun
TN 101-25
25 cm / 9 5/8"



1/2

Schroeder
TN 103-25
25 cm / 9 5/8"



1/2

Duplay
TN 108-25
28 cm / 11 "



1/2

Bozemann
CM 211-26
26 cm / 10 2/8"
S-shape

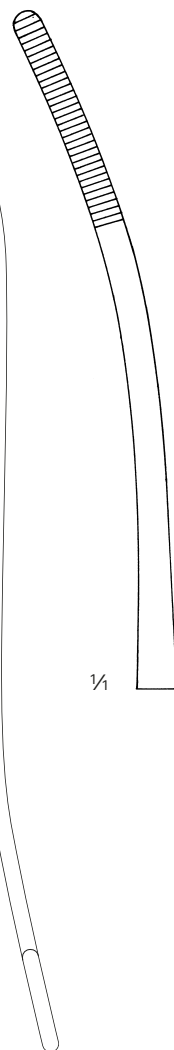

1/4

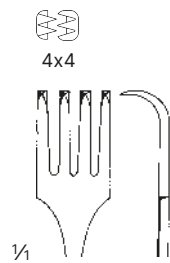

Braun
TN 207-15
16 cm / 6 2/8"

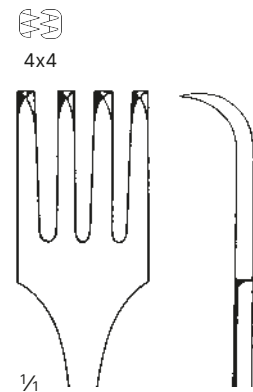

TN 102-25
26,5 cm / 10 3/8"

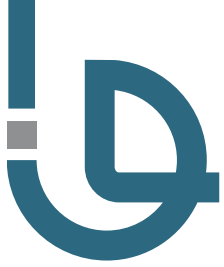

Gynecology and Obstetric Instruments

Uterine Tenaculum Forceps



2x2

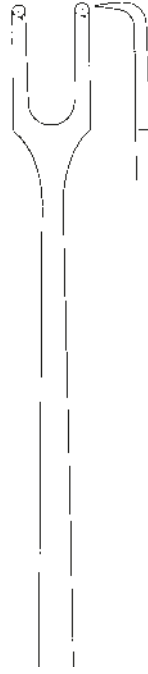

TN 208-20

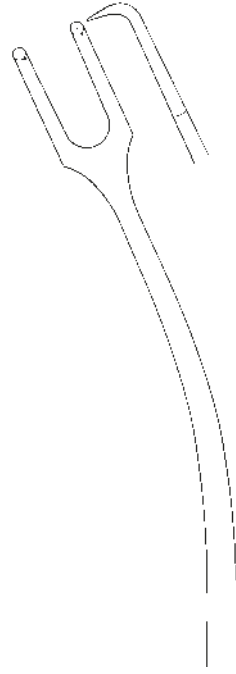

TN 208-21



1/2

Schröder
25 cm / 9 7/8"

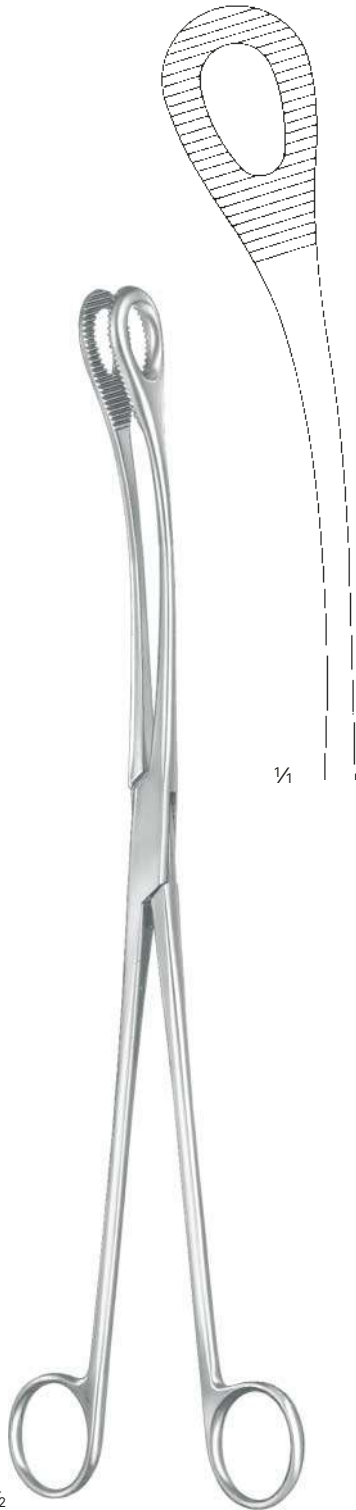

1/2

Kelly
CM 218-32
32 cm / 12 5/8"

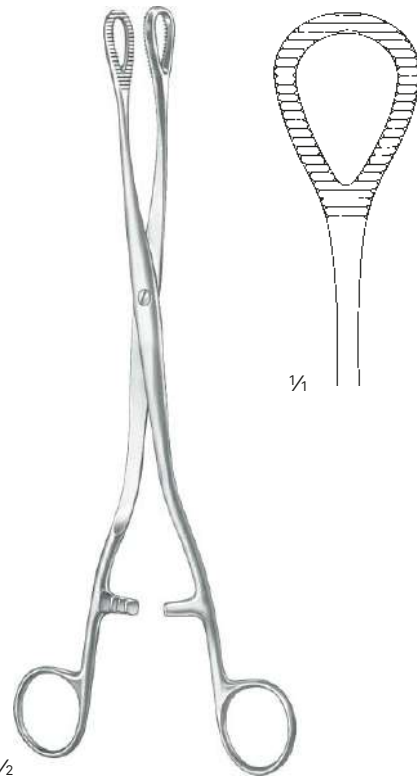

1/2

Heywood-Smith
CM 220-21
20 cm / 7 7/8"



1/2

Atraumatic

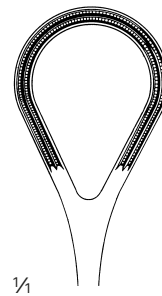

1/4

CM 250-25
25 cm / 9 7/8"

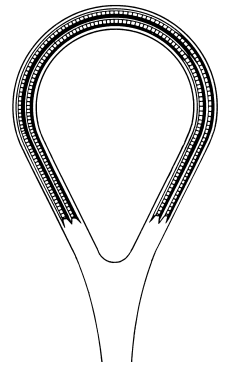

CM 250-27
27 cm / 10 5/8"



Ø 25 mm



1/2

Doyen
SP 150-15
15 cm / 5 7/8"

Ø 17 mm



1/2

Doyen
SP 150-19
19 cm / 7 4/8"



Novak
OG 100-24
24 cm / 9 3/8"
with Luer-Lock connection

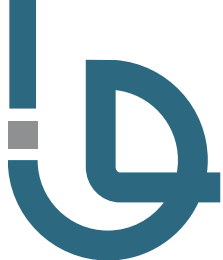

Schumacher

RG 550-01

24 cm / 9 4/8"

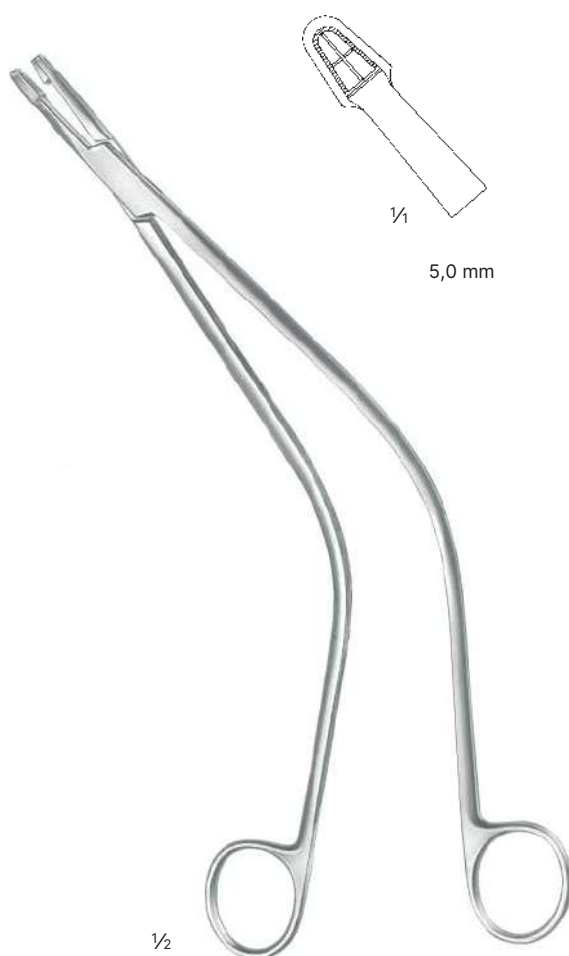

Schubert

RG 550-02

24 cm / 9 4/8"

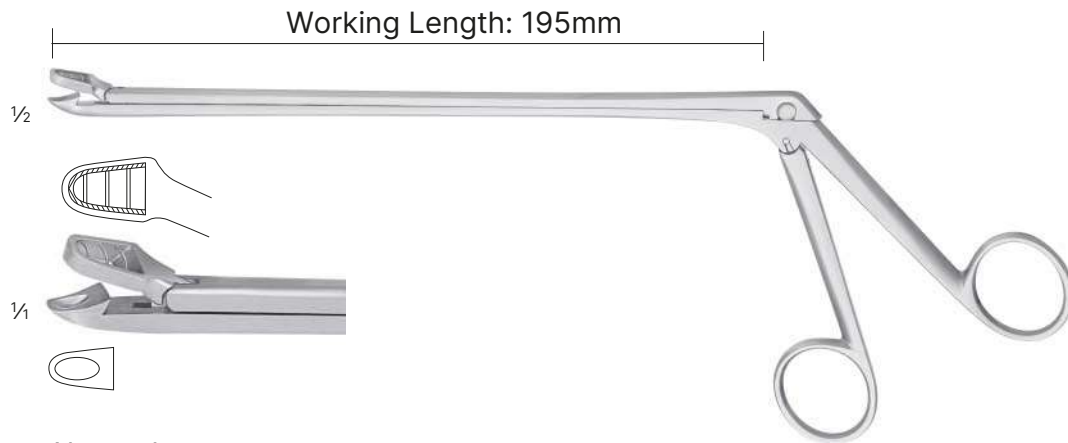

Alexander
RG 551-01

retrograde cutting, jaws curved to left, suitable also
in colposcopy jaw 5,1 mm wide

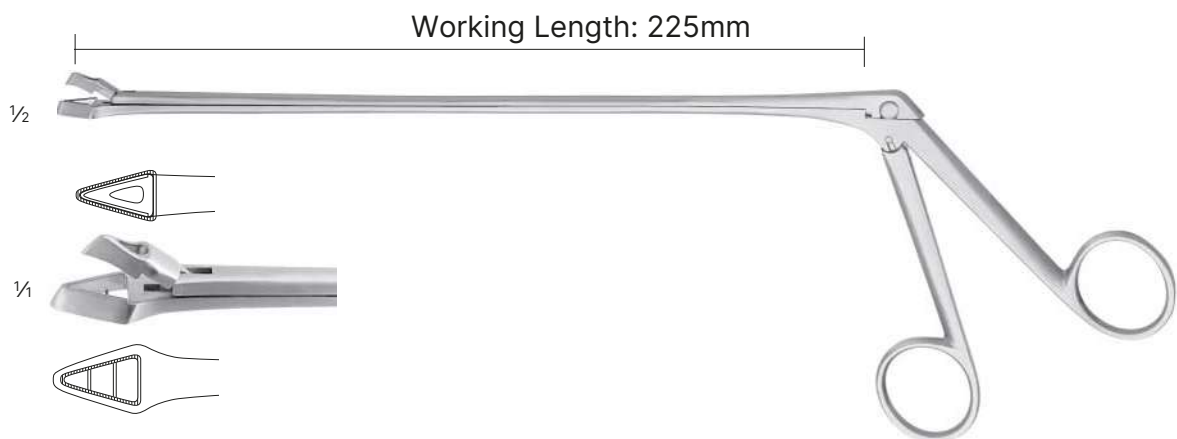

Schumacher
RG 551-02

jaw 5,4 mm wide



1/2

Recamier

| Fig. | width | sharp,rigid |
|------|-------|-------------|
| 00 | 5 mm | OG 110-04 |
| 0 | 7 mm | OG 110-07 |
| 1 | 9 mm | OG 110-08 |
| 2 | 11 mm | OG 110-10 |
| 3 | 12 mm | OG 110-12 |
| 4 | 14 mm | OG 110-14 |
| 5 | 15 mm | OG 110-15 |
| 6 | 16 mm | OG 110-16 |
| 7 | 19 mm | OG 110-18 |
| 8 | 20 mm | OG 110-19 |
| 9 | 21 mm | OG 110-21 |
| 10 | 23 mm | OG 110-23 |
| 11 | 25 mm | OG 202-26 |
| 12 | 30 mm | OG 202-28 |
| 13 | 35 mm | OG 200-34 |
| 14 | 40 mm | OG 200-39 |





1/2

HS 115-00

35 cm / 13 5/8"

with spring connector, self retaining,
complete with 2 interchangeable cones
large and small

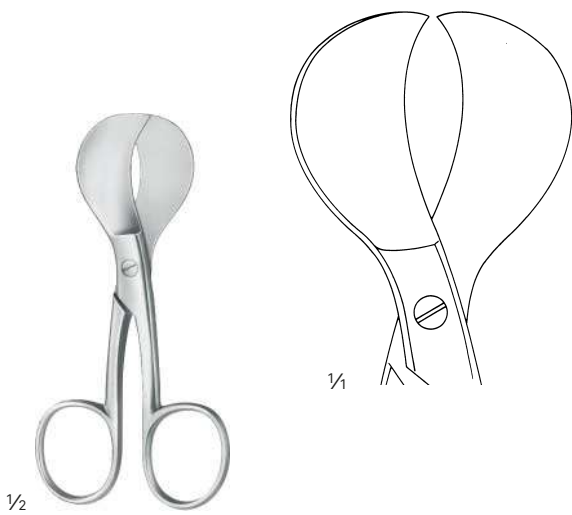

Mod. USA
MA 456-10
 10,5 cm / 4¹/₈"

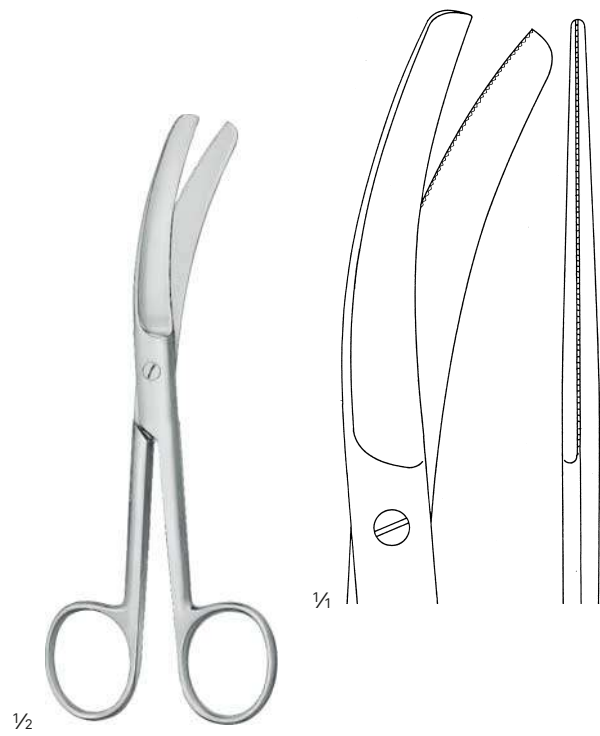

Busch
MA 458-16
 16 cm / 6²/₈"
 one toothed cutting edge

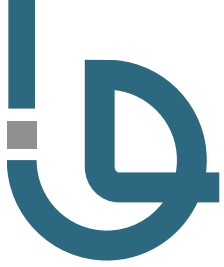

Braun-Stadler
MA 453-14
14,5 cm / 5⁵/₈"

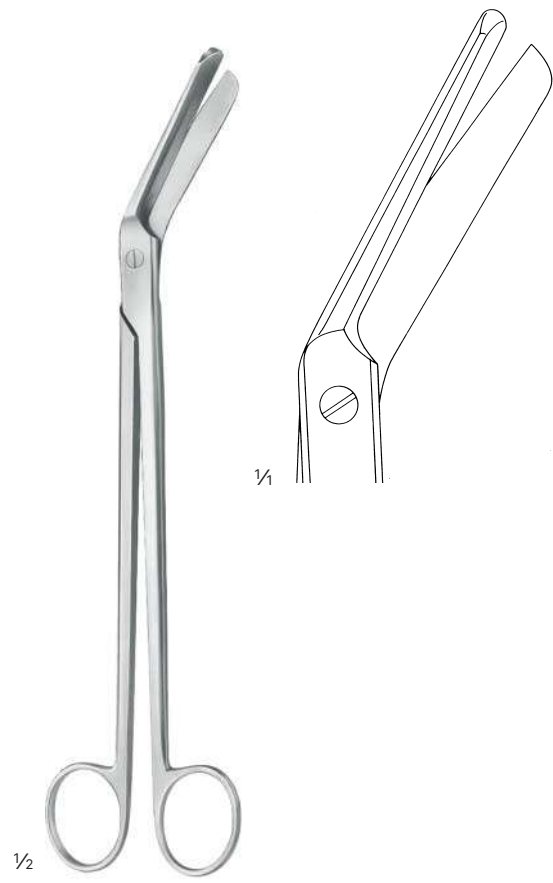
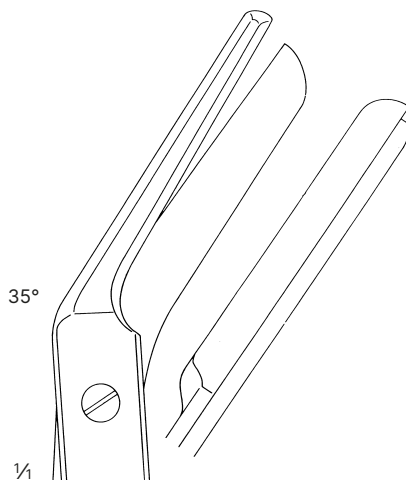

Braun-Stadler
MA 453-22
22 cm / 8⁵/₈"



1/2

Nägele

TN 100-35

35 cm / 13 5/8"



1/3

Winter

28 cm / 11"

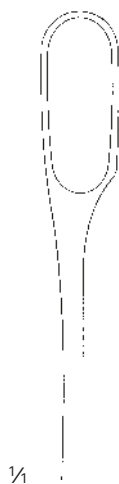

1/4

9,5 mm

Fig.1

CM 252-01



13,5 mm

Fig.2

CM 252-02



9,5 mm

Fig.1

CM 262-01



13,5 mm

Fig.2

CM 262-02

Bone and Traumatology Instruments

Osteotoms
Gouges
Chisels
Spongiosa Gouges
Mallets
Bone Curette
Periosteal Raspatories
Bone Files and Rasp
Elevators
Bone Levers
Knee Retractors
Spinal Retractors
Meniscus and Cartilage Forceps
Bone Reposition Forceps
Bone Holding Forceps
Bone Holding Clamps
Bone Rongeurs
Bone Cutting Forceps
Wire Saws
Hand Drills
Screw Drivers
Wire Traction Bows
Wire Guides
Bone Wires
Wire Holders
Flat Nose Pliers
Wire Cutting Pliers
Plaster Shears
Plaster Spreaders



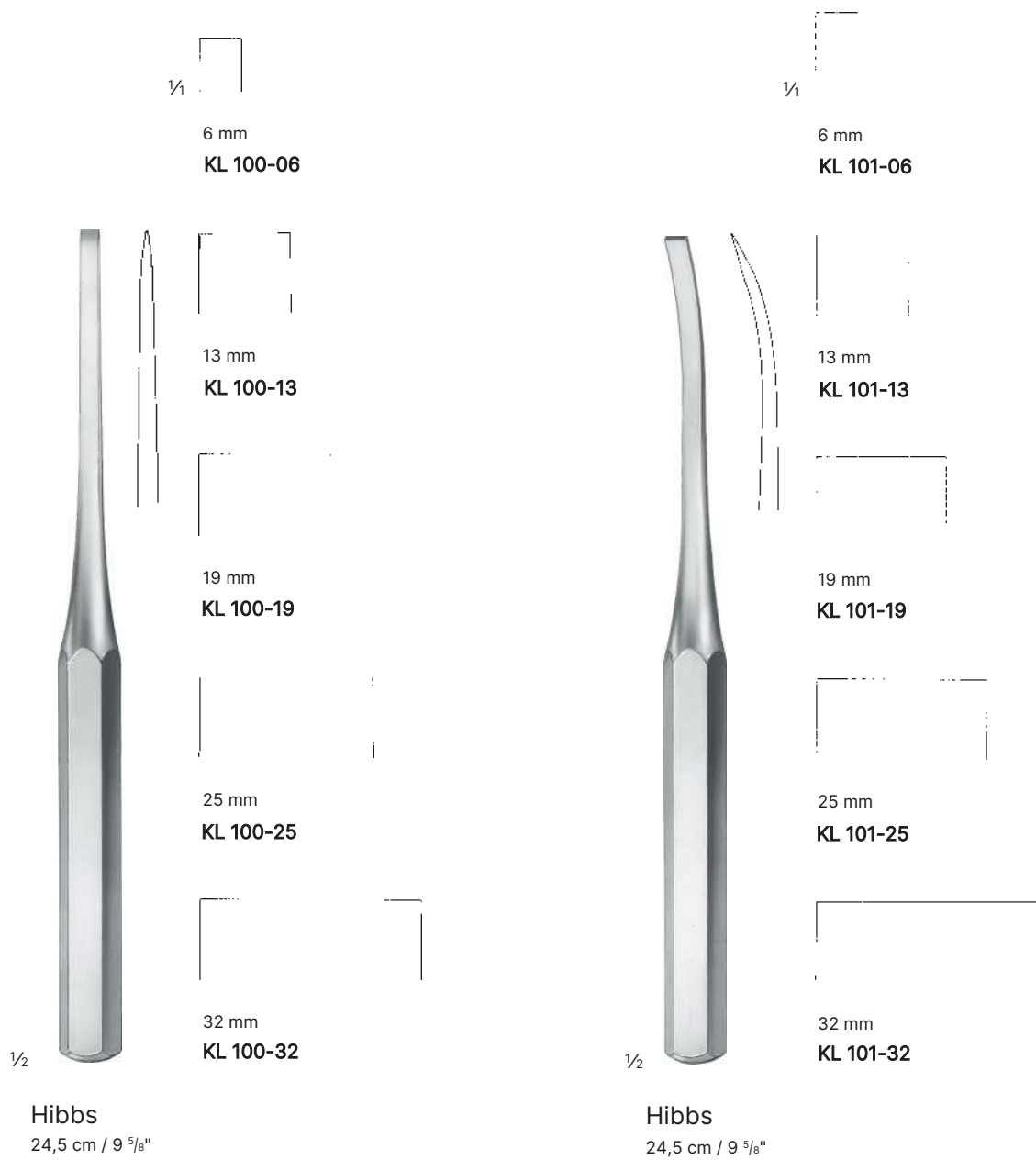

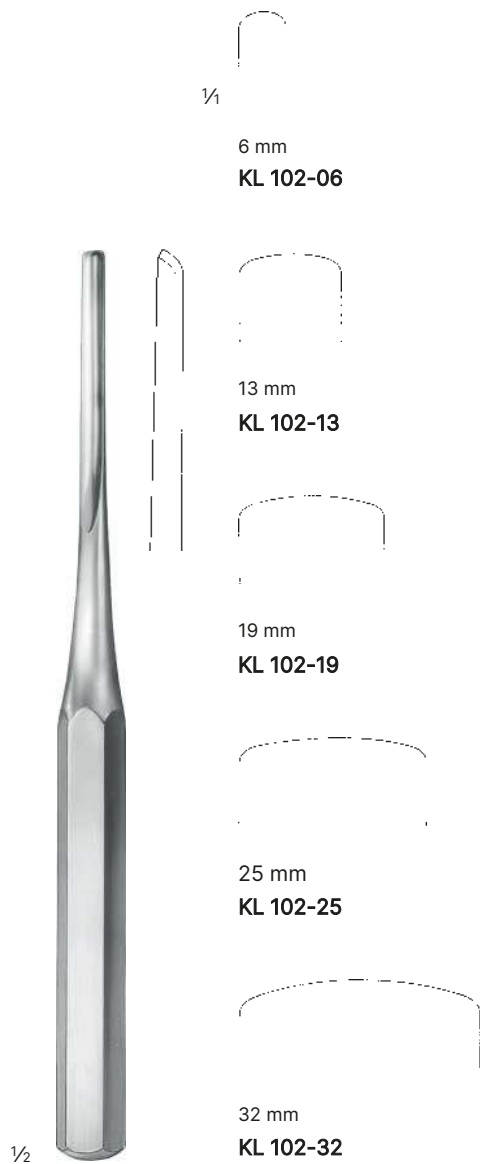

Hibbs
24,5 cm / 9 5/8"

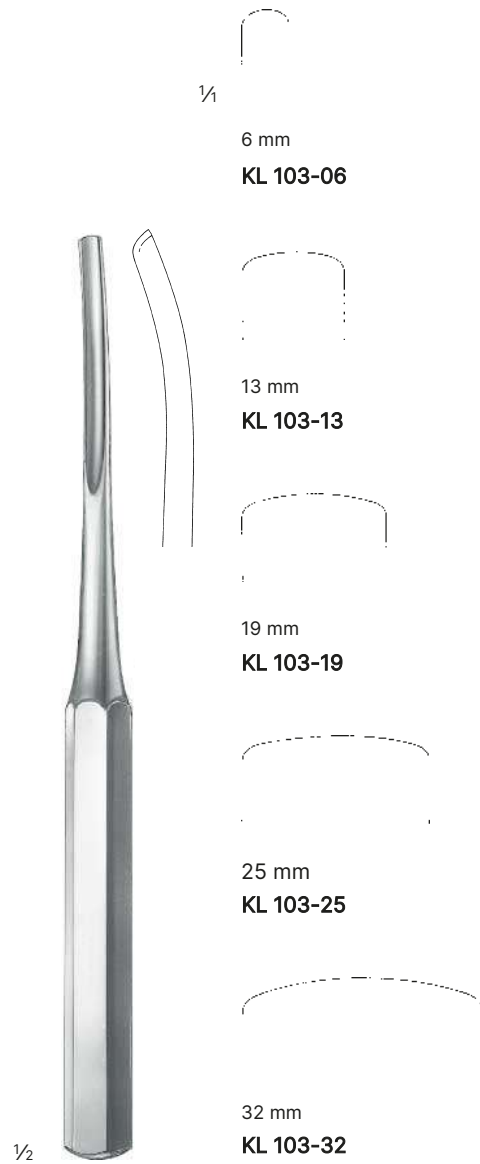

Hibbs
24,5 cm / 9 5/8"

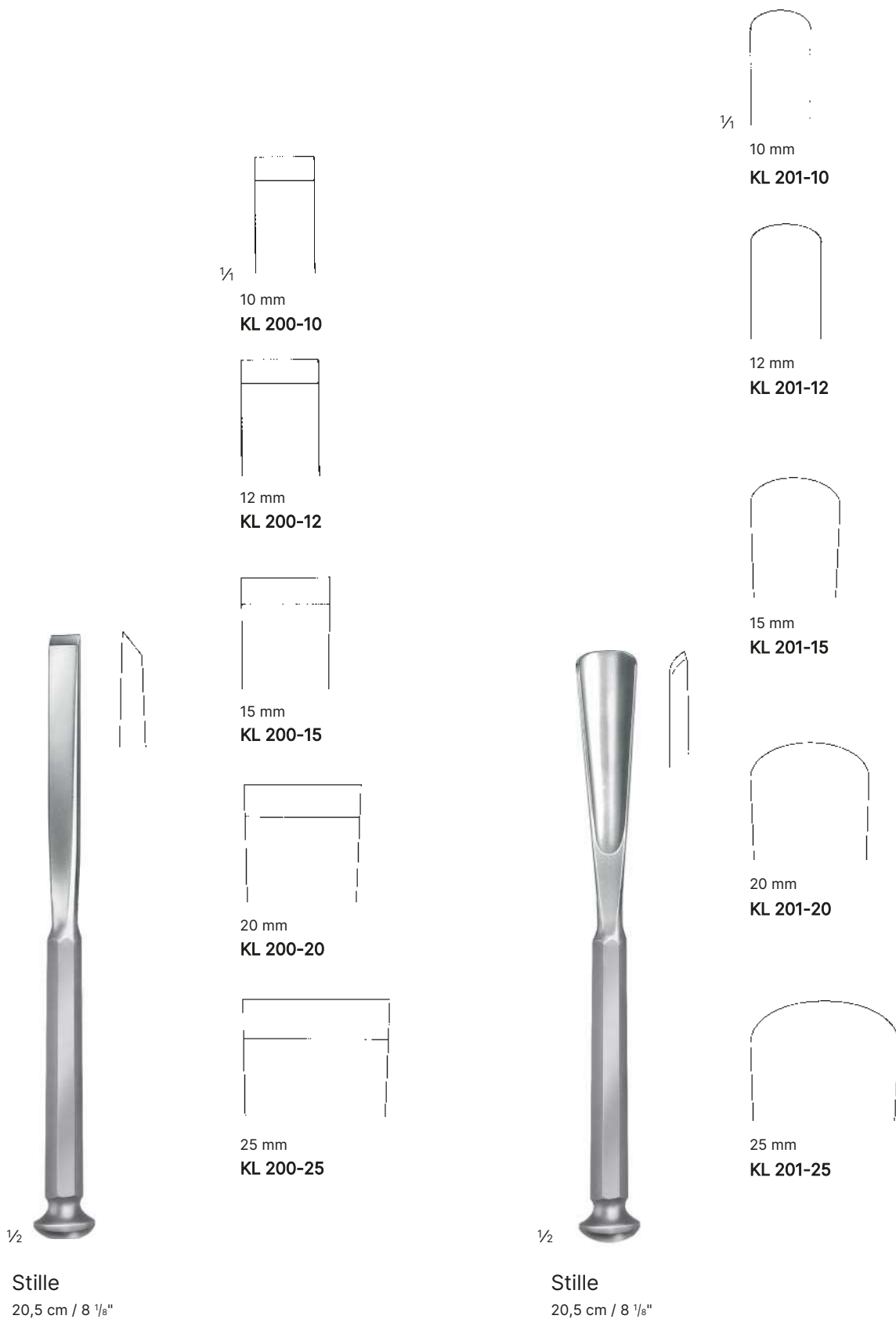

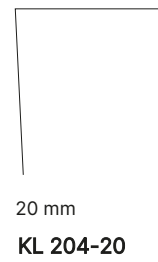
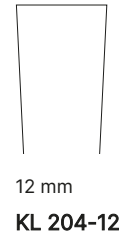
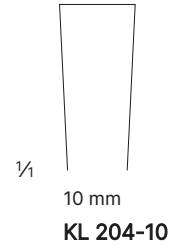
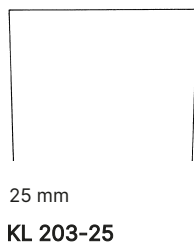
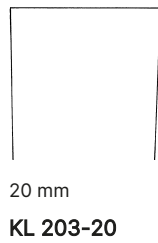
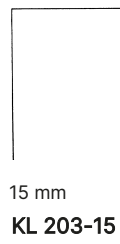
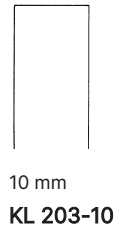
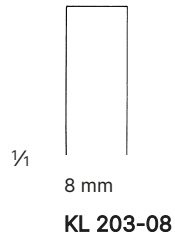

Stille
20,5 cm / 8 1/8"



Stille
20,5 cm / 8 1/8"
delicate



2 mm
KB 498-02



3 mm
KB 498-03



4 mm
KB 498-04



6 mm
KB 498-06



8 mm
KB 498-08



10 mm
KB 498-10



12 mm
KB 498-12



15 mm
KB 498-15



1/2

Lambotte-Mini
12,5 cm / 4 7/8"

The image displays two Lambotte osteotomes, one on the left and one on the right, both with a length of 24 cm (9 4/8"). Each instrument is shown with a series of technical drawings representing different widths. The left instrument has a straight blade, while the right one has a curved blade. The widths are listed in millimeters and their corresponding model numbers are provided.

| Width (mm) | Model Number |
|------------|--------------|
| 4 | KL 250-04 |
| 8 | KL 250-08 |
| 10 | KL 250-10 |
| 13 | KL 250-13 |
| 15 | KL 250-15 |
| 18 | KL 250-18 |
| 20 | KL 250-20 |
| 25 | KL 250-25 |
| 30 | KL 250-30 |
| 38 | KL 250-38 |
| 44 | KL 250-44 |
| 50 | KL 250-50 |
| 8 | KL 251-08 |
| 13 | KL 251-13 |
| 18 | KL 251-18 |
| 20 | KL 251-20 |
| 25 | KL 251-25 |
| 30 | KL 251-30 |
| 38 | KL 251-38 |

Lambotte
24 cm / 9 4/8"

Lambotte
24 cm / 9 4/8"



Bone and Traumatology Instruments

Spongiosa Gouges



1/4

5 mm

KL 406-05



1/4

5 mm

KL 407-05



1/2

Lexer

25 cm / 9 7/8"

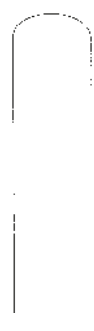

10 mm

KL 406-10



10 mm

KL 407-10



15 mm

KL 406-15

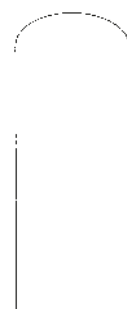

15 mm

KL 407-15



1/2

Lexer

25 cm / 9 7/8"

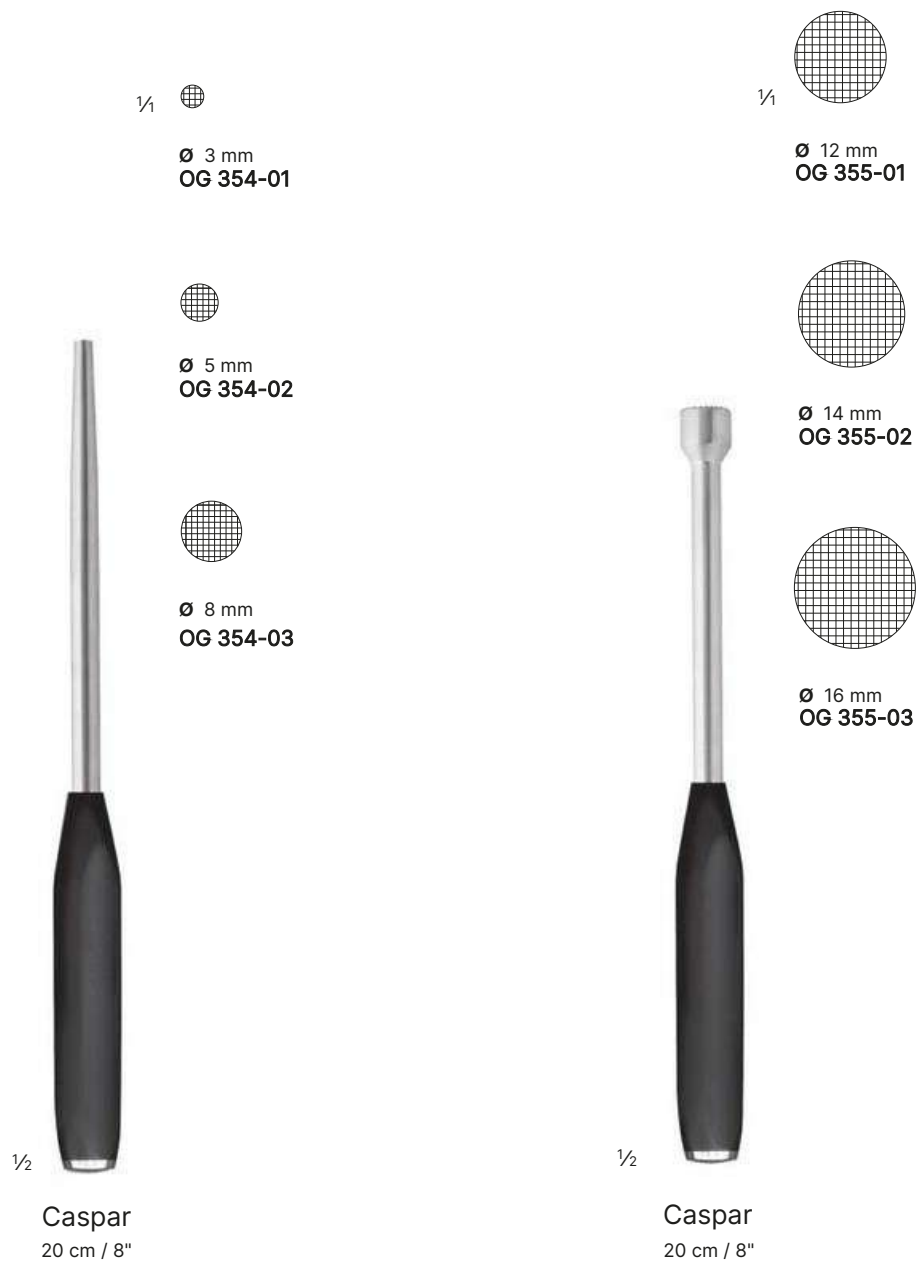



Ø 27 mm



1/2

Mead

KL 600-20

19 cm / 7 4/8"
with interchangeable
plastic disks

Ø 25 mm



1/2

KB 900-18

18,5 cm / 7 4/8"
with plastic insert

KB 901-18

Plastic insert for KB 900-18, pair

Ø 30 mm



1/2

Cottle

KB 902-18

19 cm / 7 4/8"
plane / convex

Ø 20 mm



1/2

Williger

KL 600-22

16,5 cm / 6 4/8"

Ø 34 mm



1/2

KL 602-24
24,5 cm / 9 5/8"

Ø 40 mm



1/2

Ombredanne
KB 902-24
24 cm / 9 1/2"

Ø 45 mm



1/2

Bergmann
KB 906-24
24,5 cm / 9 3/7"



Bone and Traumatology Instruments

Bone Curettes

1/4



3,5 mm
Fig.000

OG 248-01



4,0 mm
Fig.00

OG 248-02

1/4



Ø 3,0 mm
Fig.000

OG 250-01



4,5 mm
Fig.0

OG 248-03



5,5 mm
Fig.1

OG 248-04



Ø 4,0 mm
Fig.00

OG 250-02



Ø 5,0 mm
Fig.0

OG 250-03

oval spoon



6,0 mm
Fig.2

OG 248-05



7,5 mm
Fig.3

OG 248-06



Ø 6,0 mm
Fig.1

OG 251-01



Ø 8,0 mm
Fig.2

OG 251-02



8,5 mm
Fig.4

OG 248-07



10,0 mm
Fig.5

OG 248-08



Ø 10,0 mm
Fig.3

OG 251-03



Ø 12,0 mm
Fig.4

OG 251-04

1/2



Bruns

23 cm / 9 "

1/2



Bruns

17 cm / 6 5/8"



3,5 mm

Fig.000

OG 252-01



4 mm

Fig.00

OG 252-02



3,0 mm

Fig.0000

OG 254-01



3,7 mm

Fig.000

OG 254-02



5 mm

Fig.0

OG 252-03



5,5 mm

Fig.1

OG 253-01



4,5 mm

Fig.00

OG 254-03



5,2 mm

Fig.0

OG 254-04



6,5 mm

Fig.2

OG 253-02



7,5 mm

Fig.3

OG 253-03



6,8 mm

Fig.1

OG 254-05



8,5 mm

Fig.2

OG 255-01

oval spoon



9,0 mm

Fig.4

OG 253-04



1/2

Schede

17 cm / 6 5/8"

oval spoon



10,0 mm

Fig.3

OG 255-02



11,5 mm

Fig.4

OG 255-03



1/2

Volkmann

17 cm / 6 5/8"



13,0 mm

Fig.5

OG 255-04



14,5 mm

Fig.6

OG 255-05



1/4 

2,8 mm

Fig.0000

OG 259-01



3,6 mm

Fig.000

OG 259-02



4,4 mm

Fig.00

OG 259-03

oval spoon



1/2

Daubenspeck

20 cm / 7 7/8"



5,2 mm

Fig.0

OG 259-04

oval spoon

1/4 

2,0 mm

Fig.1

OG 257-02



2,4 mm

Fig.2

OG 257-03



2,6 mm

Fig.3

OG 257-04



2,8 mm

Fig.4

OG 257-05

1/2

Lempert

21,5 cm / 8 4/8"



4,8 mm

OG 260-01



4,8 mm

OG 261-01

oval spoon



4,8 mm

OG 262-01



1/2

25 cm / 9 7/8"

round spoon



Ø 6,5 mm



1/2

6,0 mm

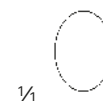

1/4
oval spoon

OG 706-21

21 cm / 8 2/8"

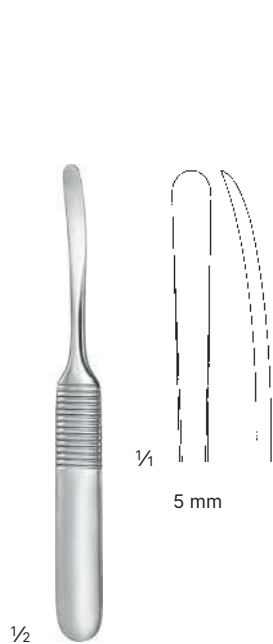

Williger
OG 277-01
13 cm / 5 1/8"

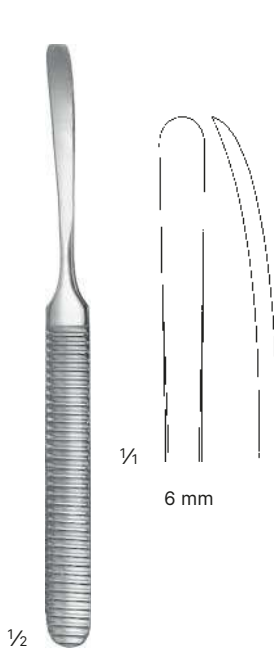

Williger
OG 277-02
16 cm / 6 3/8"



OG 288-02
16,5 cm / 6 5/8"

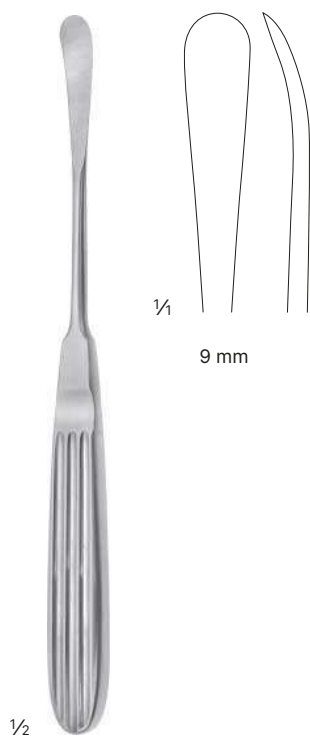

Cottle
KB 463-20
19,5 cm / 7 5/8"

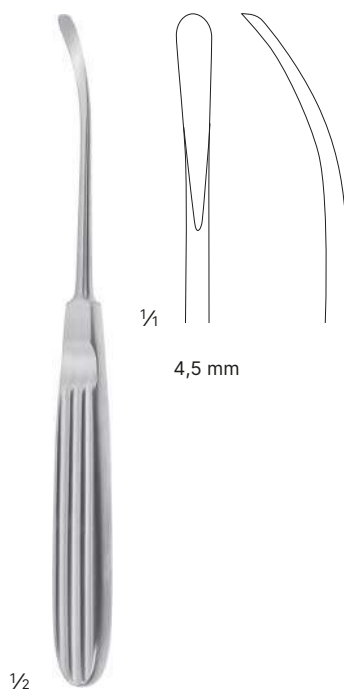

Landolt
OG 279-17
17,5 cm / 6 7/8"



1/2

Farabeuf
15 cm / 5 7/8"

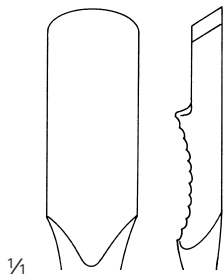

1/4

12,5 mm

OG 280-14

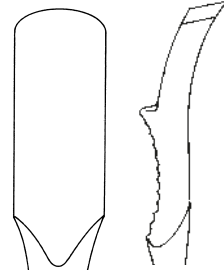

12,5 mm

OG 281-14



1/2

Farabeuf-Collin
16 cm / 6 2/8"



1/4

11 mm

OG 282-16

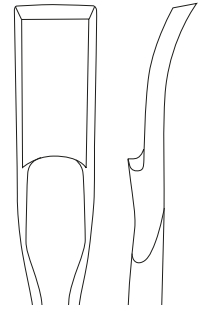

11 mm

OG 283-16



1/2

Sedillot
OG 284-18
18,5 cm / 7 2/8"

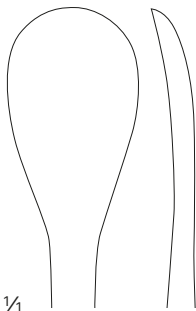

1/4

18 mm

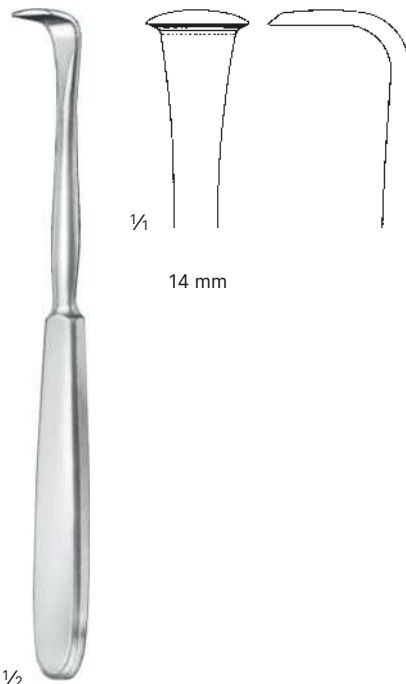

1/2

Langenbeck
OG 286-18
19 cm / 7 4/8"

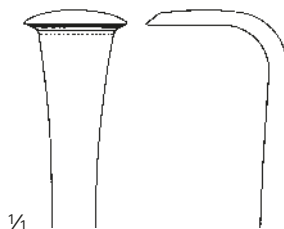

1/4

14 mm

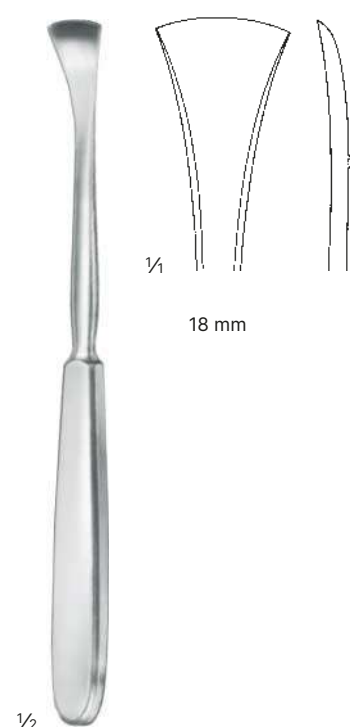

1/2

Langenbeck
OG 286-19
19 cm / 7 4/8"

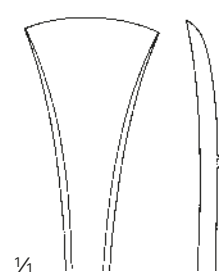

1/4

18 mm

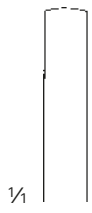
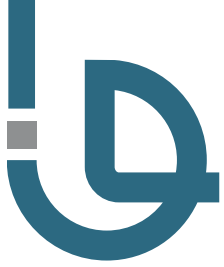

5 mm

OG 276-05



10 mm

OG 276-10

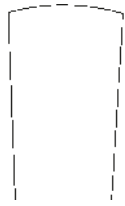

15 mm

OG 276-15

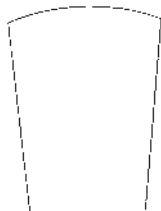

20 mm

OG 276-20

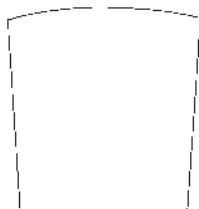

25 mm

OG 276-25

1/2



Lambotte
21,5 cm / 8 4/8"



1/2

Cobb
28 cm / 11"



10 mm

OG 291-10



13 mm

OG 291-13

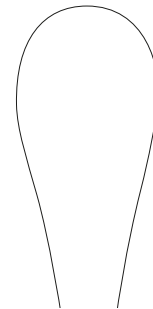

19 mm

OG 291-19

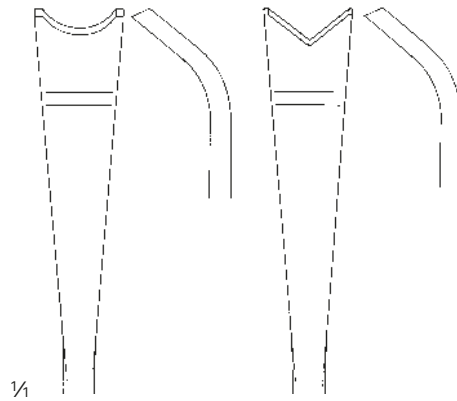

12 mm

Fig.1

OG 451-01

18,5 cm / 7 2/8"

12 mm

Fig.2

OG 451-02

21,5 cm / 8 3/8"

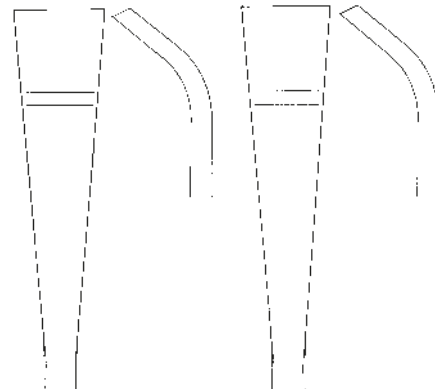

13 mm

Fig.3

OG 451-03

18,5 cm / 7 2/8"

13 mm

Fig.4

OG 451-04

21,5 cm / 8 3/8"

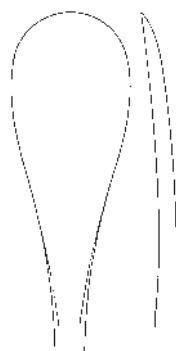

15 mm

Fig.5

OG 451-05

21 cm / 8 2/8"

Semb

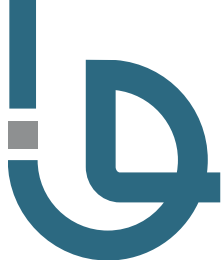

1/2

Doyen

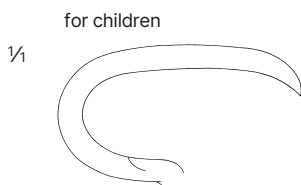

1/4

OG 424-01
17,5 cm / 6 7/8"



OG 424-02
17,5 cm / 6 7/8"

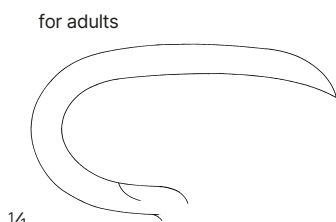

1/4

OG 423-01
17,5 cm / 6 7/8"



OG 423-02
17,5 cm / 6 7/8"



OG 350-01
19 cm / 7 4/8"

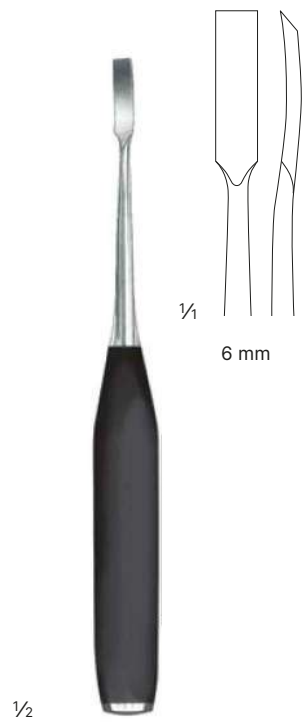

OG 350-02
18 cm / 7 1/8"



OG 350-03
18 cm / 7 1/8"

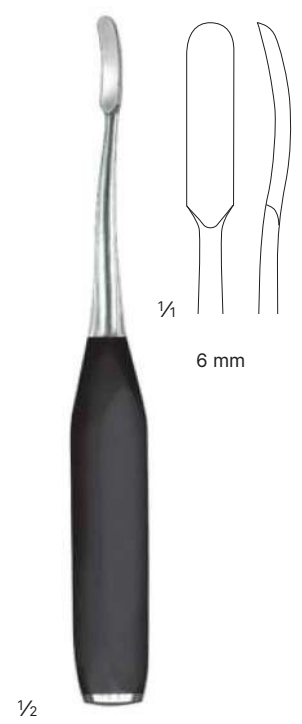

OG 350-04
18 cm / 7 1/8"



OG 351-01
20 cm / 7 7/8"



OG 351-02
20 cm / 7 7/8"

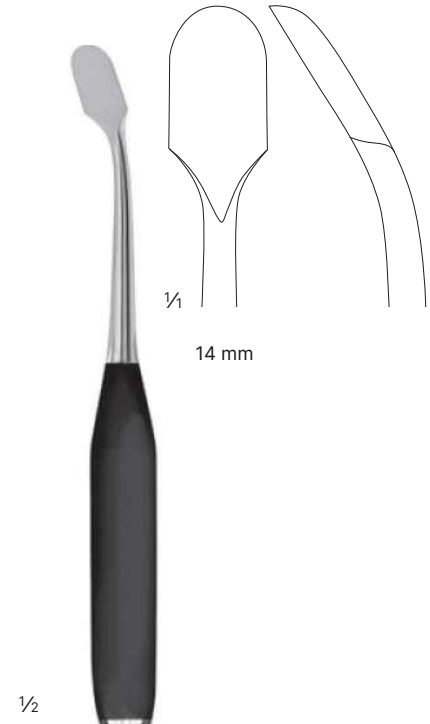

OG 351-03
20 cm / 7 7/8"

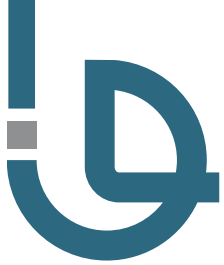

1/2

Miller

downwards cutting

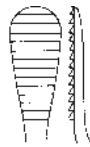

6,6 mm

Fig.1

KB 516-01

18 cm / 7 1/8"

4,5 mm

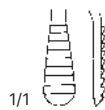

1/1

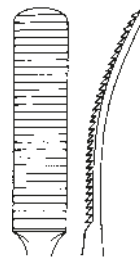

6,8 mm

Fig.2

KB 516-02

18 cm / 7 1/8"

6,2 mm

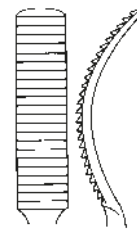
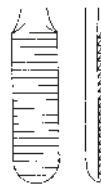

7,0 mm

Fig.3

KB 516-03

18 cm / 7 1/8"

4,6 mm

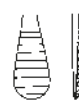

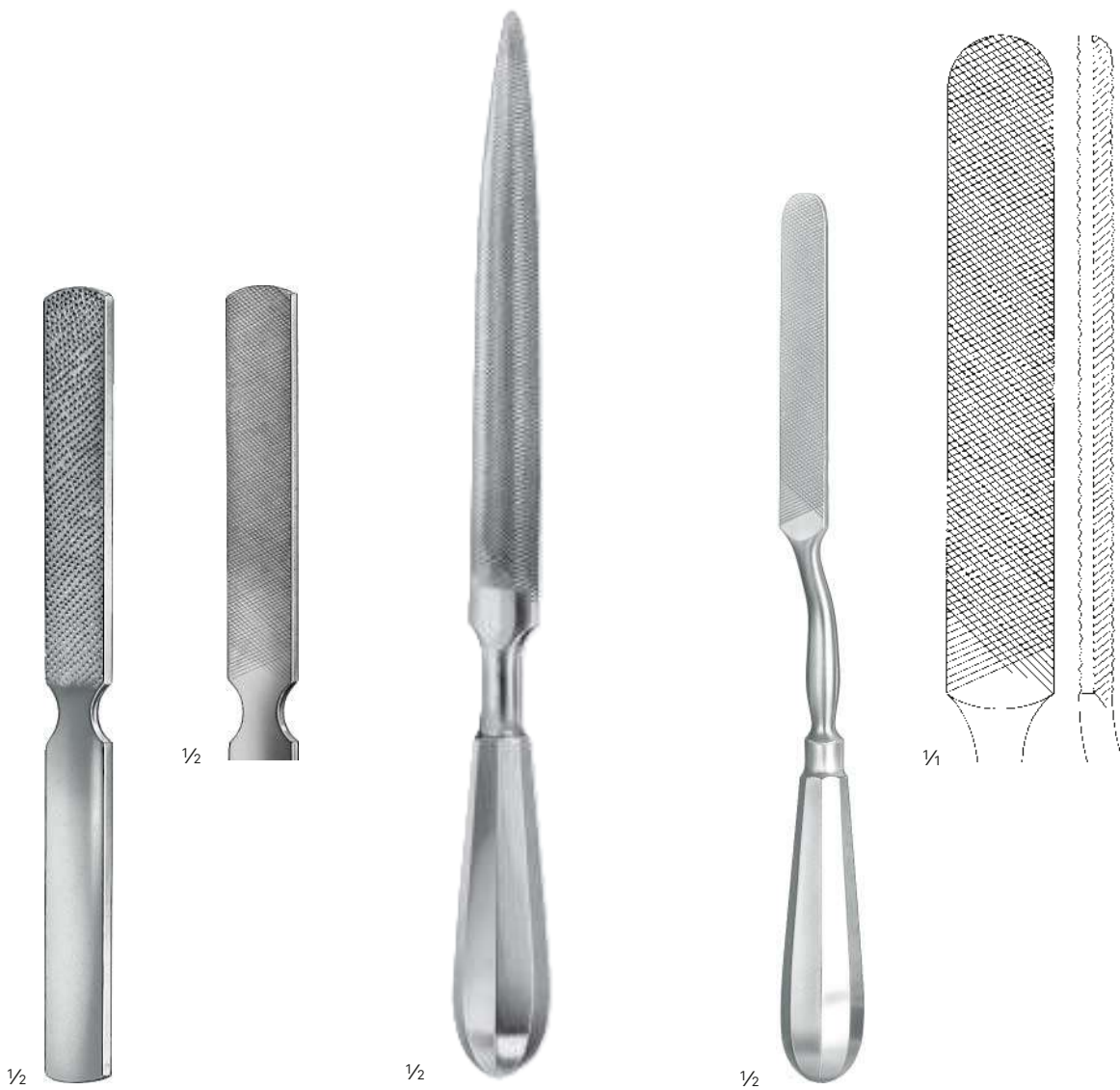

OM 420-22
22 cm / 8 5/8"

OM 421-19
29 cm / 11 3/8"

OM 422-24
24 cm / 9 3/8"

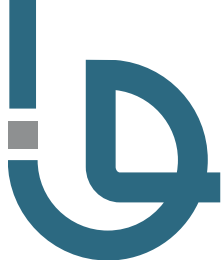

Bone and Traumatology Instruments

Elevators

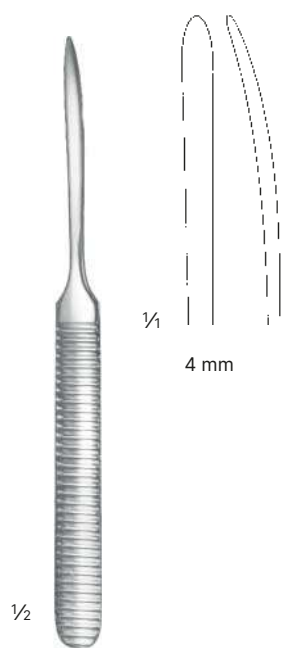

Williger
OG 220-01
16 cm / 6 2/8"

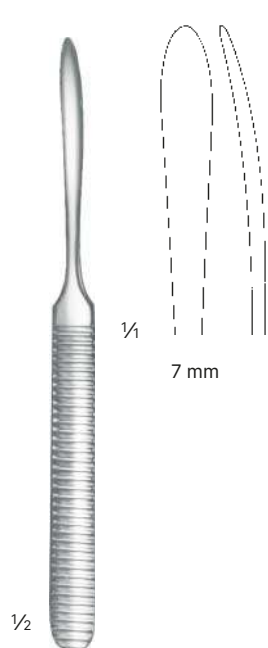

Williger
OG 220-02
17 cm / 6 6/8"

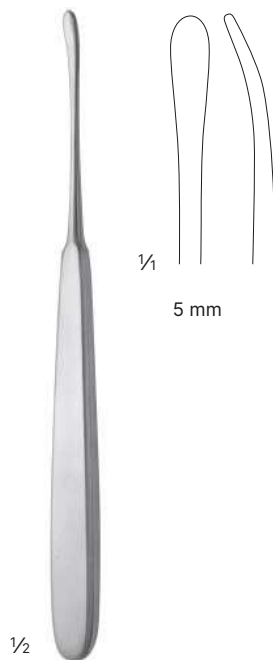

Sebileau
OG 220-17
17 cm / 6 6/8"

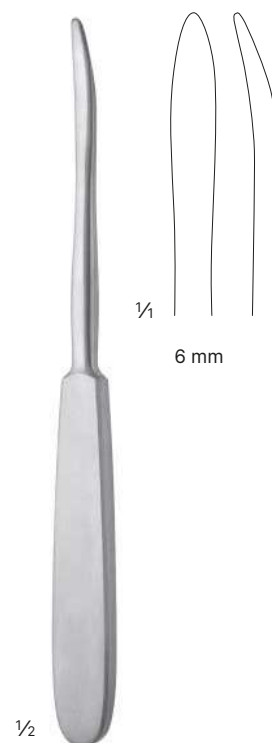

Quervain
OG 221-19
19,5 cm / 7 5/8"



Langenbeck

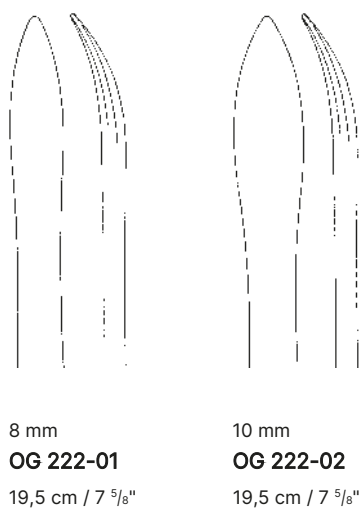

8 mm
OG 222-01
19,5 cm / 7 5/8"

10 mm
OG 222-02
19,5 cm / 7 5/8"

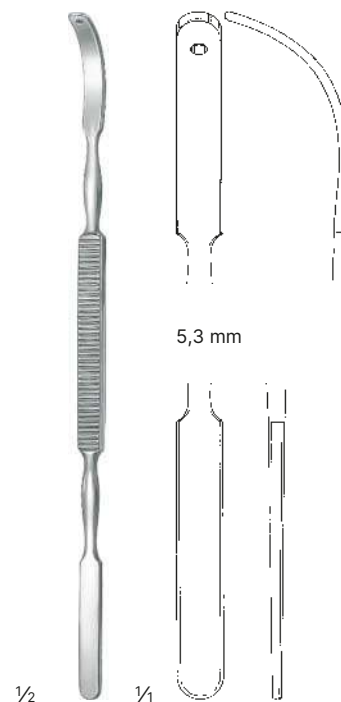

McDonald
KB 357-19
18,5 cm / 7 2/8"

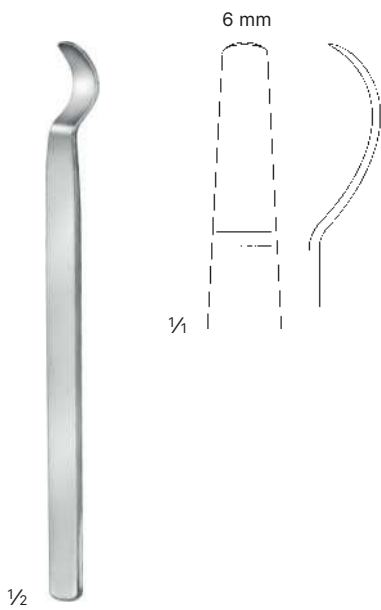

YC 216-15
15 cm / 5 7/8"

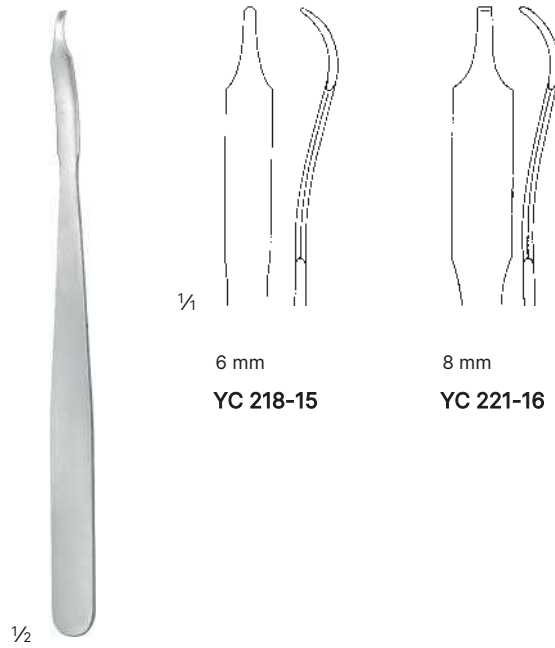

Hohmann Mini
16 cm / 6 2/8"

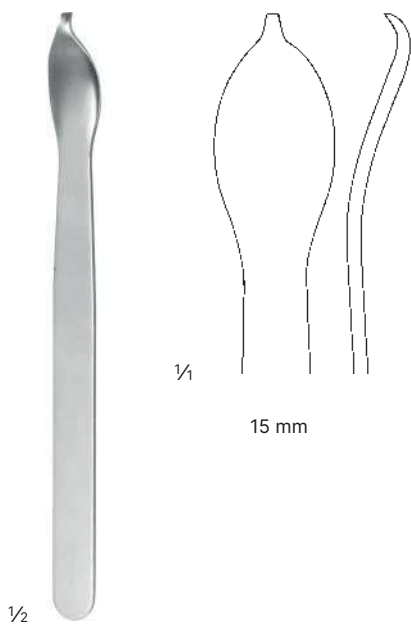

YC 219-15
16 cm / 6 2/8"

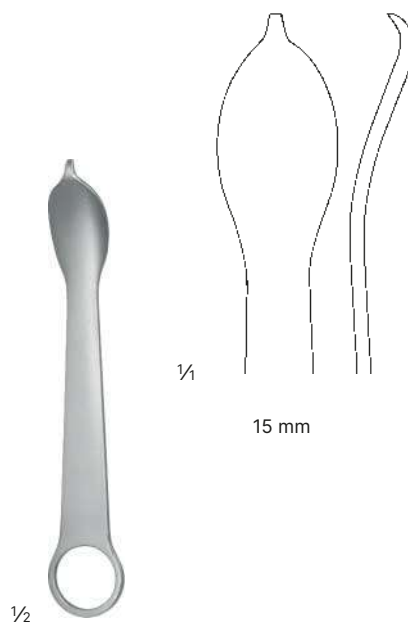

YC 220-15
12 cm / 4 6/8"

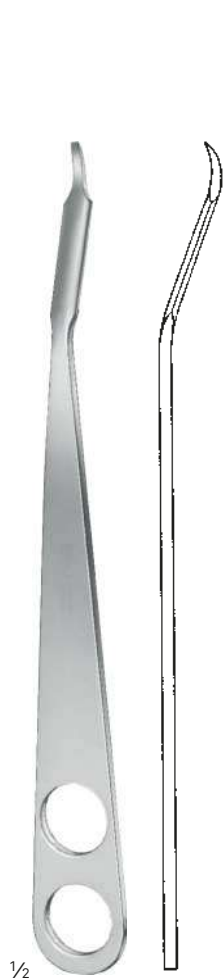

8 mm
Hohmann
YC 211-22
22 cm / 8 ⁵/₈"

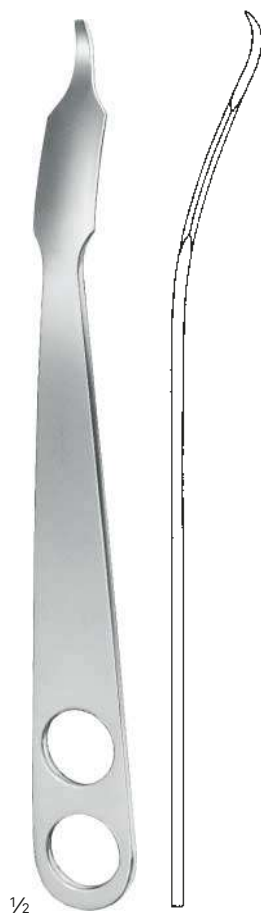

18 mm
Hohmann
YC 213-24
24 cm / 9 ⁴/₈"

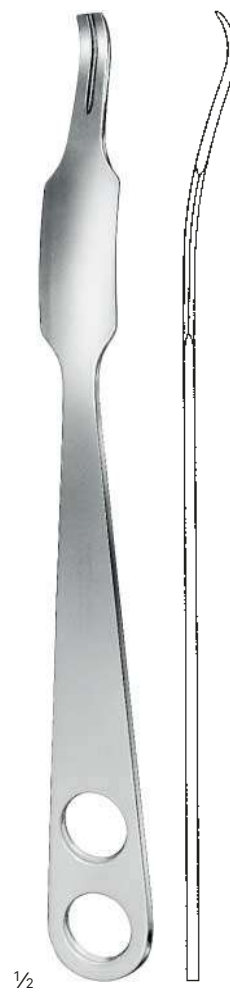

22 mm
Lange-Hohmann
YC 214-25
25 cm / 9 ⁷/₈"

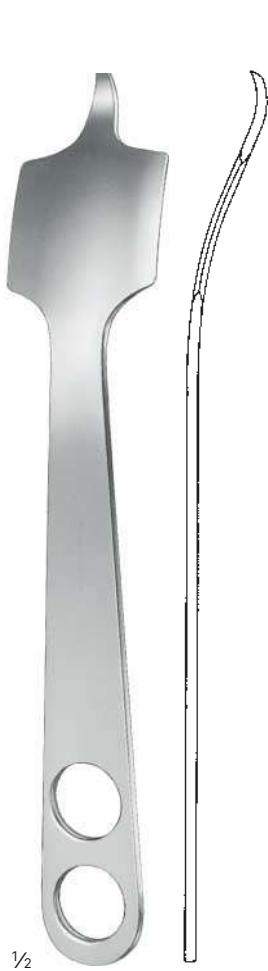

43 mm
Hohmann
YC 208-24
23,5 cm / 9 2/8"



70 mm
Hohmann
YC 208-25
25 cm / 9 7/8"



43 mm
Hohmann
YC 212-24
24 cm / 9 5/8"

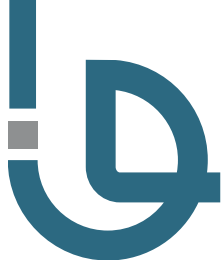

22 mm
Hohmann
YC 206-26
26 cm / 10 ²/₈"



35 mm
Hohmann
YC 207-28
28,5 cm / 11 ¹/₈"



24 mm
Hohmann
YC 209-26
27,5 cm / 10 ⁷/₈"



1/2

Bennett

1/4

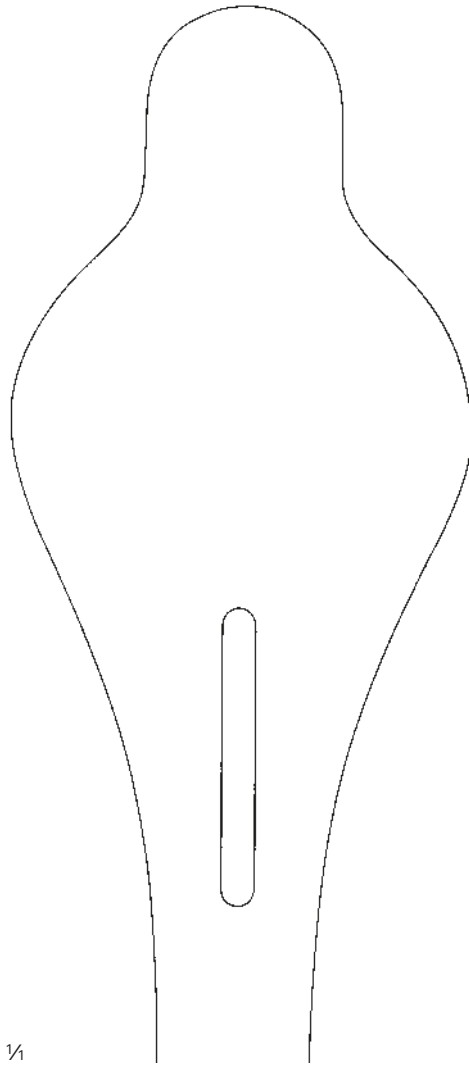

60 mm

YC 201-23

23,5 cm / 9 2/8"

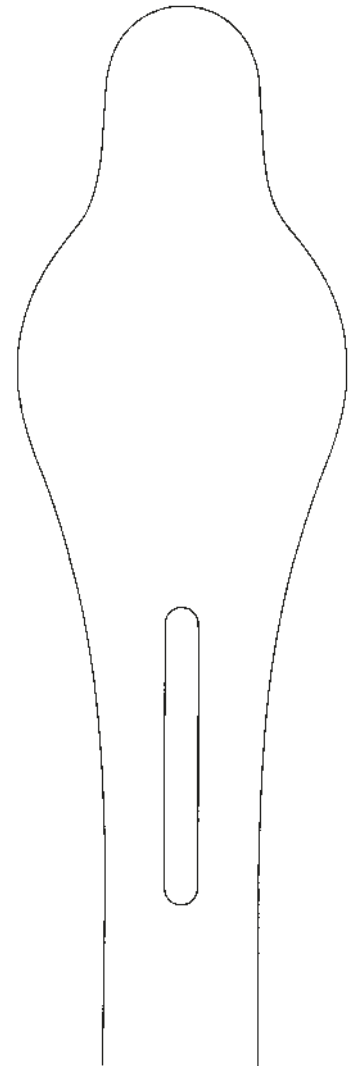

43 mm

YC 202-34

24 cm / 9 4/8"

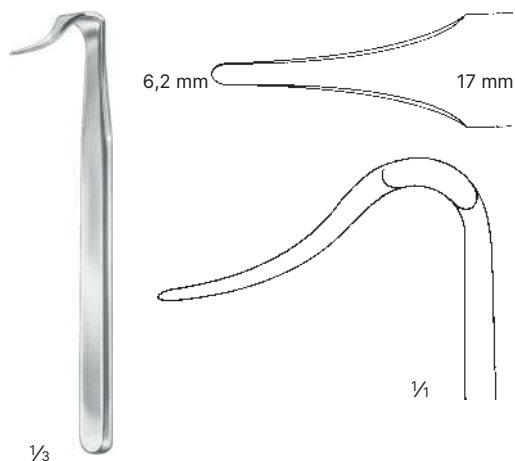

Blount
YC 200-17
17,5 cm / 6 ⁷/₈"



39 mm
Blount
YC 215-26
26,5 cm / 10 ³/₈"



47 mm
Blount
YC 215-28
26,5 cm / 10 ³/₈"



Taylor
16 cm / 6 ²/₈"

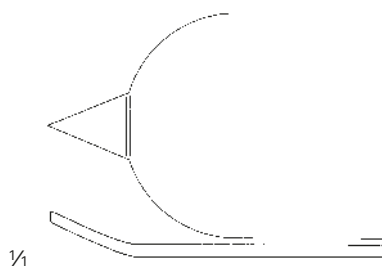

95 x 30 mm
EK 228-07
16 cm / 6 ²/₈"

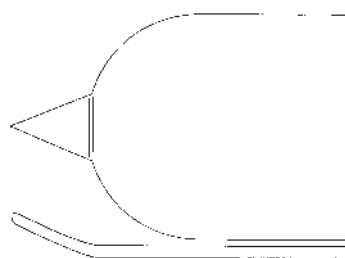

115 x 30 mm
EK 228-10
16 cm / 6 ²/₈"



Bircher-Ganske

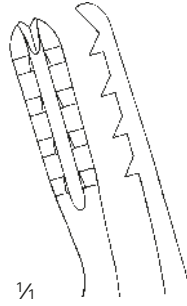

OM 152-01

20 cm / 7 7/8"

curved upwards

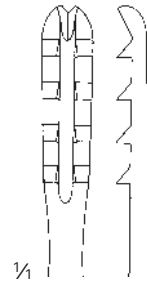

OM 200-37

20,5 cm / 8 1/8"

straight



Bircher-Ganske

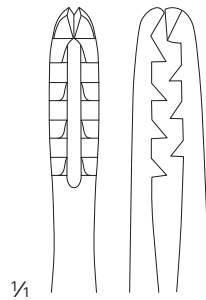

OM 152-02

20 cm / 7 7/8"

curved sideways

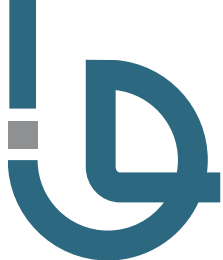

Bone and Traumatology Instruments

Bone Reposition Forceps



1/2

OM 230-13

13,5 cm / 5 3/8"



1/2

OM 230-15

15 cm / 5 7/8"

long ratchet

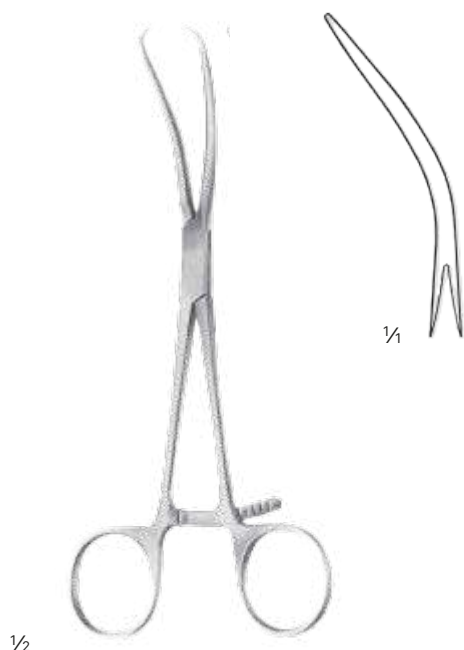

1/2

OM 230-17

17 cm / 6 3/4"



1/2

OM 230-20

20 cm / 7 7/8"

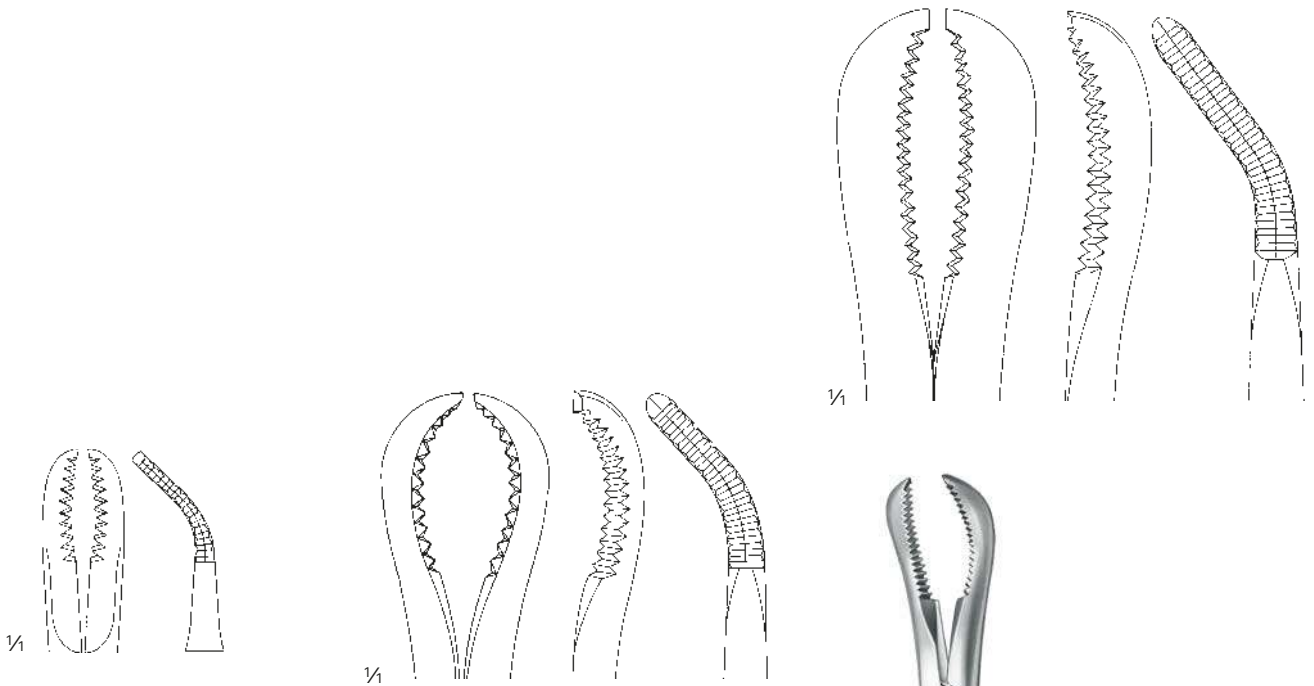

OM 231-14
14 cm / 5 4/8"



OM 231-17
17 cm / 6 4/8"



OM 231-23
23,5 cm / 9 1/8"

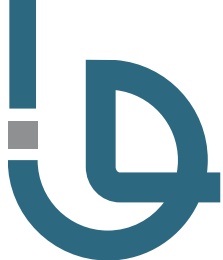

Bone and Traumatology Instruments

Bone Holding Forceps



Kern

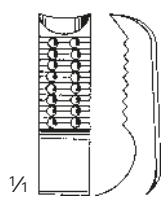

OM 205-15
15,5 cm / 6 1/8"

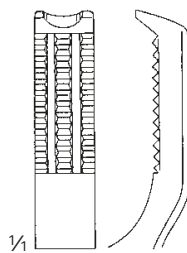

OM 205-24
24 cm / 9 1/8"

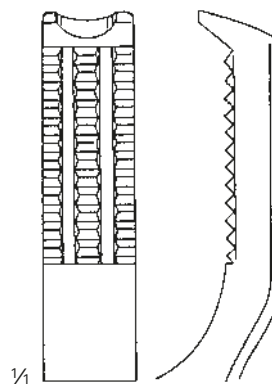

Lane
OM 205-32
32 cm / 13 "



1/1

OG 300-14
15 cm / 5 7/8"



OG 300-19
20 cm / 7 7/8"

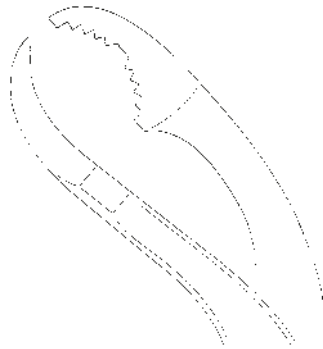

OG 300-24
24 cm / 9 4/8"

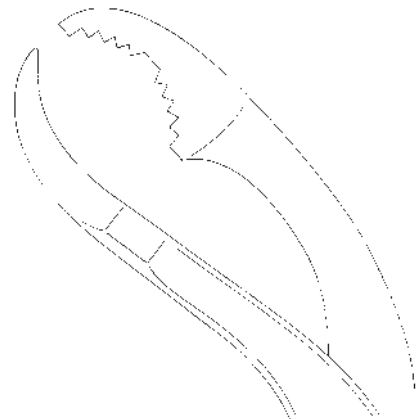

OG 300-26
26 cm / 10 2/8"



self-centering, with thread fixation

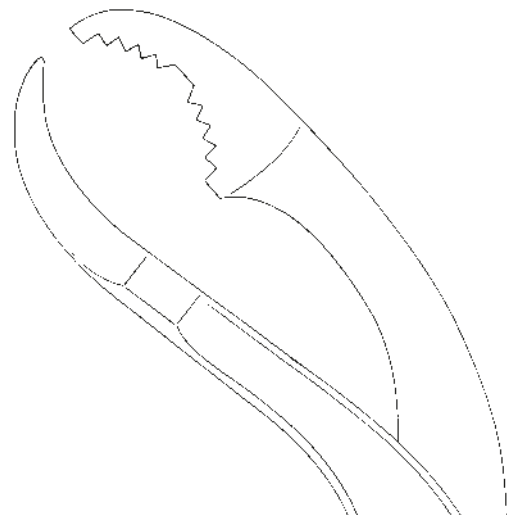
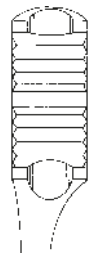

OG 300-28
28 cm / 11 "

1/2



Bone and Traumatology Instruments

Bone Holding Forceps

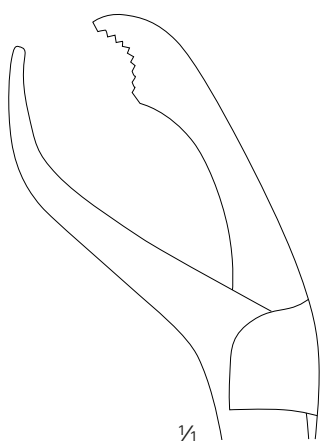
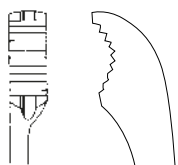

Verbrugge

OG 301-17

17,5 cm / 6 ⁷/₈"

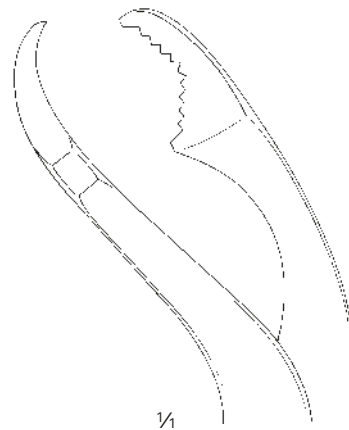

OG 302-01
25,5 cm / 10 ²/₈"

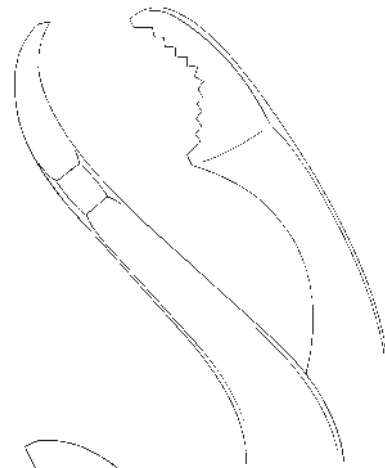

OG 302-02
26,5 cm / 10 ³/₈"

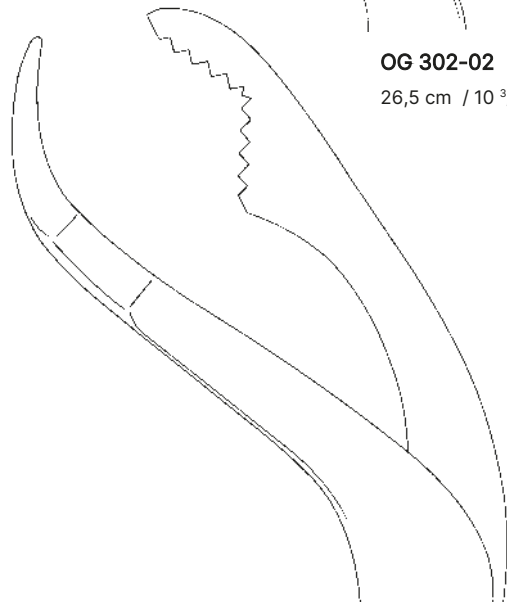

OG 302-03
27,5 cm / 10 ⁷/₈"



¹/₂
Verbrugge

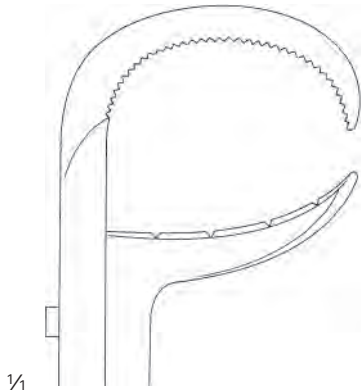
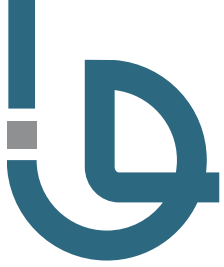

1/4

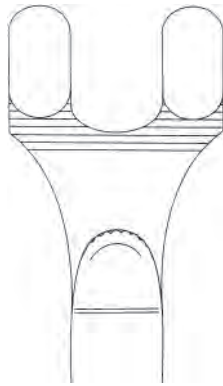

OM 310-17

17 cm / 6 4/8"



1/2 Lowman-Hoglund

OM 312-17

17,5 cm / 7"



1/2

Gerster-Lowman

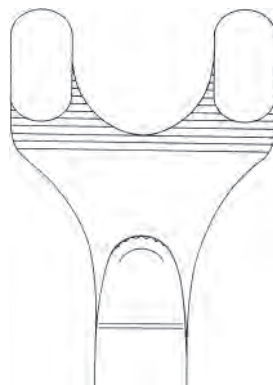

OM 310-20

20,5 cm / 8 1/8"

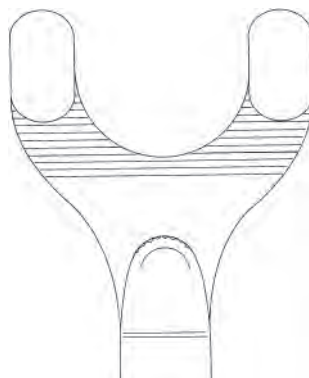

OM 311-21

21 cm / 8 2/8"



1/2

Gerster
OM 313-00



1/2

Luer



1/2

OM 319-14
15 cm / 5 9/16"

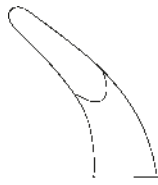

OM 319-15
15 cm / 5 9/16"



1/2

Blumenthal



1/2

OM 320-01
15,5 cm / 6 1/8"



OM 320-02
15,5 cm / 6 1/8"



1/2

Mead
OM 333-16
16 cm / 6 3/8"



1/2



1/2

Mead
OM 333-17
16,5 cm / 6 4/8"

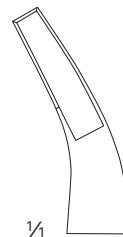

1/2



1/2

Stellbrink



1/2

OM 318-01
17,5 cm / 6 7/8"



OM 318-02
17 cm / 6 6/8"



1/2

Luer
17cm / 6 3/4"

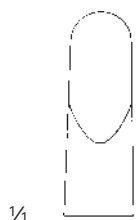

1/4

OM 340-01



OM 340-02



1/2

Hartmann
OM 322-18
18 cm / 7 1/8"

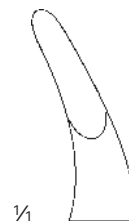

1/4



1/2

Jansen



1/4

OM 321-01
18 cm / 7 1/8"



OM 321-02
18 cm / 7 1/8"

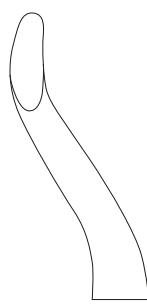

OM 329-19
19 cm / 7 5/8"



1/2

Lempert
18,5 cm / 7 1/8"



1/4

OM 330-20



OM 331-21

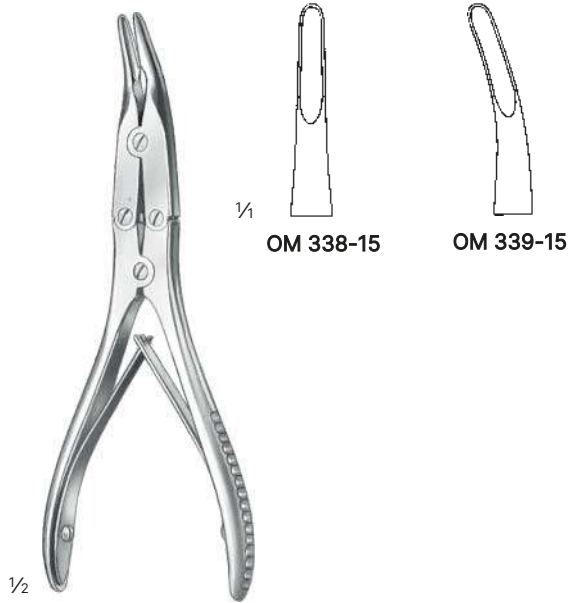

Boehler
15 cm / 5 7/8"



Beyer
OM 335-18
18 cm / 7 1/8"



Zaufal-Jansen
OM 336-18
18 cm / 7 1/8"



Mayfield
OM 340-17
17 cm / 6 5/8"

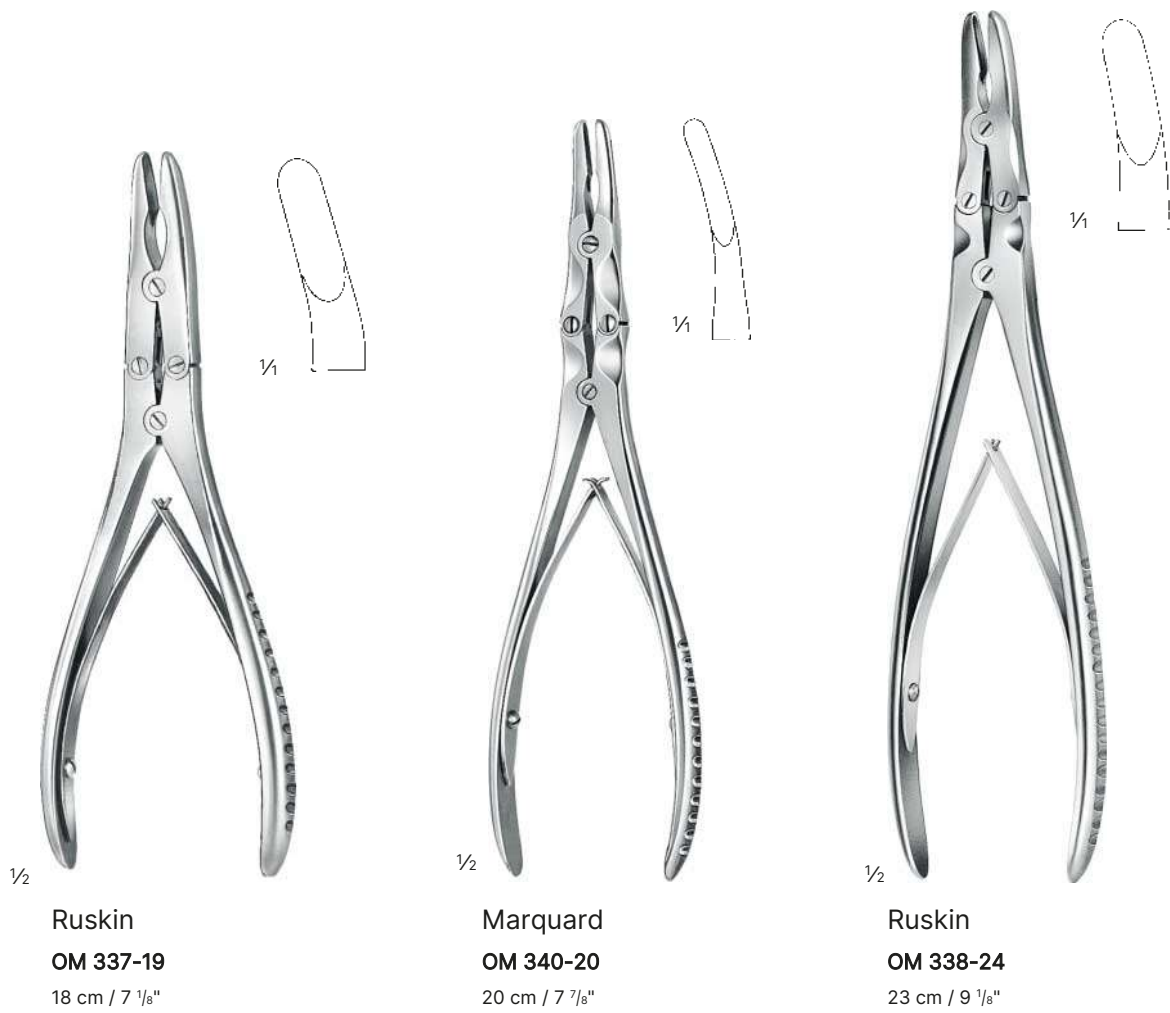
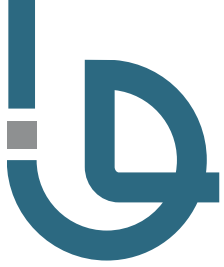

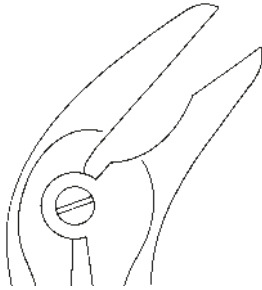

Frykholm
OM 352-24
24 cm / 9 1/8"



Leksell-Stille
OM 354-24
24 cm / 9 1/8"

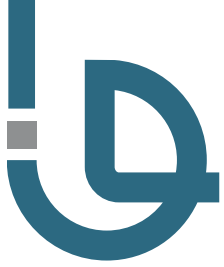

Echlin
23 cm / 9 "

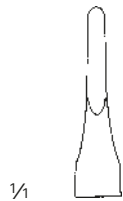

OM 350-23



OM 351-23



OM 351-25



Stille
OM 353-23
23,5 cm / 9 2/8"

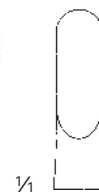

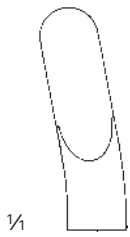

1/4

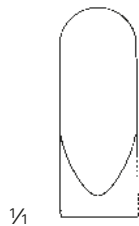

1/4

OM 357-22

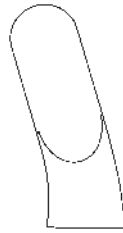

OM 258-22



1/4



1/2

Stille-Ruskin
OM 355-24
24 cm / 9 5/8"



1/2

Stille-Luer
22,5 cm / 8 7/8"



1/2

Semb
OM 358-27
23,5 cm / 9 2/8"

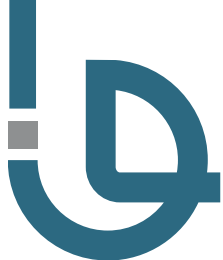

1/2

Liston

1/4



OM 360-14
14 cm / 5 4/8"



OM 360-17
17 cm / 6 6/8"

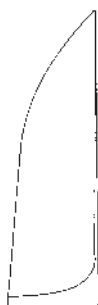

OM 360-20
20 cm / 7 7/8"

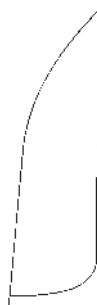

OM 360-22
22 cm / 8 5/8"



1/2

Liston

1/4



OM 361-14
14 cm / 5 4/8"



OM 361-17
17 cm / 6 6/8"

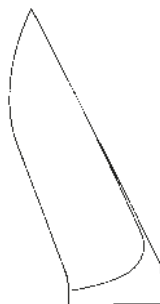

OM 361-20
20 cm / 7 7/8"

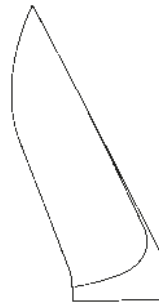

OM 361-22
22 cm / 8 5/8"

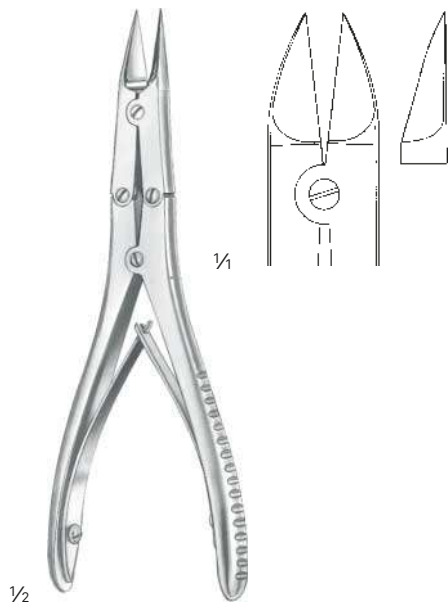

Boehler
OM 362-15
15 cm / 5 7/8"

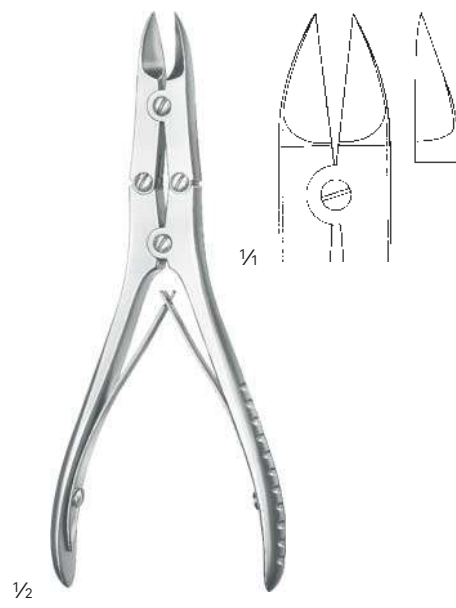

Boehler
OM 363-15
15 cm / 5 7/8"



Ruskin-Liston

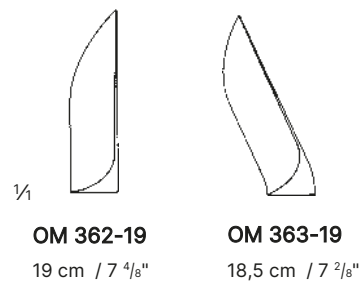

OM 362-19
19 cm / 7 4/8"

OM 363-19
18,5 cm / 7 2/8"



Stille-Liston
OM 366-28
28 cm / 11 "

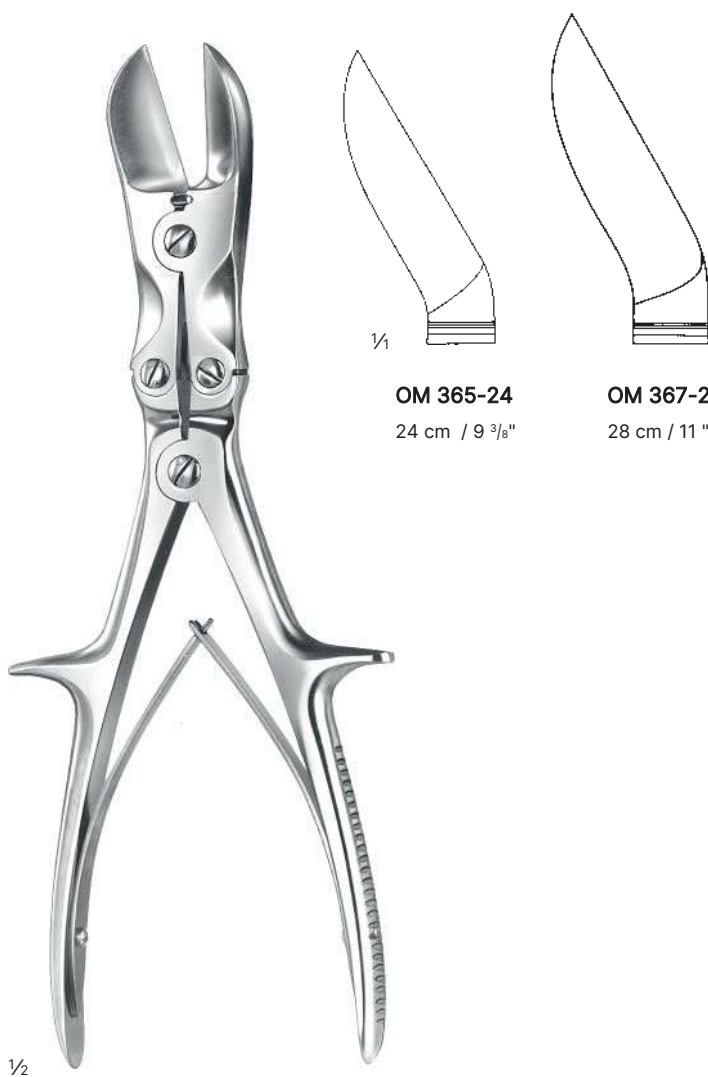

OM 365-24
24 cm / 9 3/8"

OM 367-28
28 cm / 11 "



Liston-Key-Horsley

OM 369-25

25,5 cm / 10 1/8"



1/2

Gigli

OF 940-30
30 cm / 11 6/8"

OF 940-40
40 cm / 15 6/8"

OF 940-50
50 cm / 19 6/8"



1/2

Gigli
OF 665-00
Handle



1/2

De Martel
OF 945-33
33 cm / 13 "
Guide



1/3

Fig. 1

RG 610-09

Conical burr



Fig. 2

RG 610-14

Conical burr



Fig. 3

RG 610-16

Spherical burr



Fig. 4

RG 610-22

Spherical burr



1/3

Hudson
RG 605-01
28 cm / 11 "



1/3

Fig. 5

RG 611-14

Flat burr



Fig. 6

RG 612-02

Twist drill



Fig. 7

RG 610-13

Burr

RG 605-00

complete, with burrs no. 1 - 4 and extension piece



Fig. 8

RG 605-02

Extension piece



$\frac{1}{3}$

OF 910-26



OF 900-16

Wrench

Ø 0,8 -7 mm



$\frac{1}{2}$

OF 910-16

Handle with three
jaw chuck, with key



OF 910-04

Wrench



| | 6 mm | 4 mm | 6 mm | 6 mm | 3,5 mm | 2,5 mm | 1,5 mm |
|---------------------------|-----------|-----------|-----------|-----------|-----------|-----------|-----------|
| $\frac{1}{4}$ | | | | | | | |
| 20 cm / 8 $\frac{2}{8}$ " | OF 720-20 | OF 725-20 | OF 721-20 | OF 724-20 | OF 722-20 | OF 723-20 | OF 726-20 |
| 25 cm / 9 $\frac{7}{8}$ " | OF 720-25 | OF 725-25 | OF 721-25 | OF 724-25 | OF 722-25 | OF 723-25 | OF 726-25 |



1/2

inner width

OF 880-11 180 x 100 mm
7" x 4"

OF 880-17 270 x 160 mm
10 4/8" x 6 2/8"

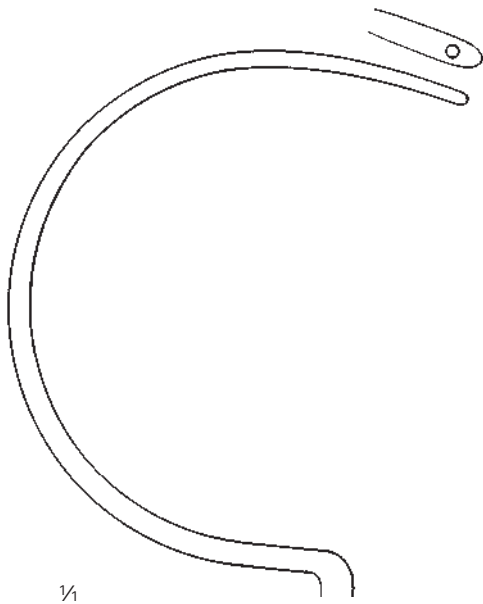

Fig. 1
OF 810-30
30,5 cm / 12 1/8"

1/4

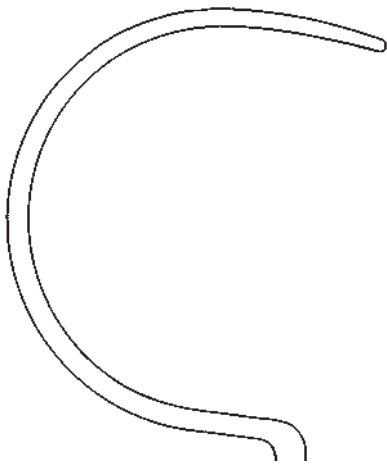

Fig. 2
OF 810-29
28,5 cm / 11 1/8"



1/2
Demel

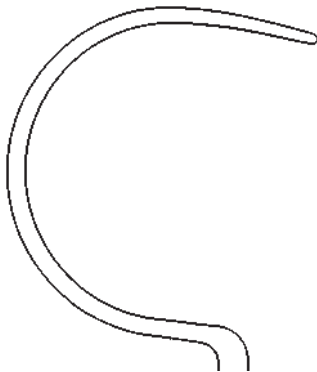
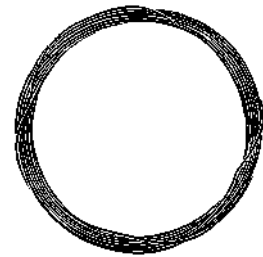
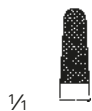
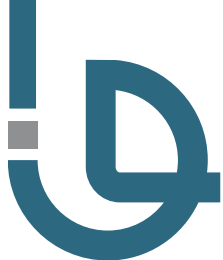

Fig. 3
OF 810-28
27,5 cm / 10 7/8"

Steel wire, soft
Length
10 m



| Ø | |
|--------|------------------|
| 0,2 mm | OF 850-02 |
| 0,3 mm | OF 850-03 |
| 0,5 mm | OF 850-05 |
| 0,6 mm | OF 850-06 |
| 0,8 mm | OF 850-08 |
| 0,9 mm | OF 850-09 |
| 1,0 mm | OF 850-10 |
| 1,2 mm | OF 850-12 |
| 1,5 mm | OF 850-15 |



PO 945-13
15 cm / 5 7/8"



PO 945-18
18 cm / 7 1/8"

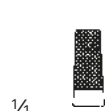

PO 946-01
15 cm / 5 7/8"



PO 946-02
18 cm / 7 1/8"



PO 949-17
17 cm / 6 3/4"



Berry
PO 947-18
18,5 cm / 7 1/8"
heavy pattern



 TC



PO 948-01

slim



PO 948-02

medium



PO 948-03

wide



1/2

18 cm / 7"

1/1



OF 457-02

slim



OF 457-03

medium



OF 457-04

wide

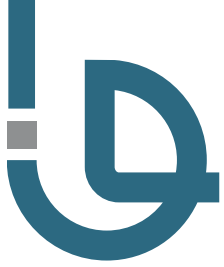

Bone and Traumatology Instruments

Flat Nose Pliers



1/2

OF 400-14
14 cm / 5 3/8"

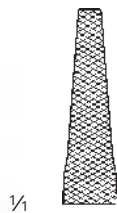

1/4



1/2

17 cm / 6 6/8"



1/4

OF 450-17



OF 451-17
with crosswise groove



1/2

OF 452-19
19 cm / 7 4/8"
pointed

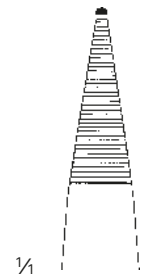

1/4



1/2

OF 455-18
18,5 cm / 7 3/8"
parallel grip

1/4



1/2

OF 456-20
20 cm / 7 7/8"
vise grip

1/4





Bone and Traumatology Instruments

Wire Cutting Pliers



Universal

12 cm / 4 ⁵/₈"

max Ø = 0,4 mm
soft wire



MA 889-12

max Ø = 1,0 mm max Ø = 0,5 mm
soft wire hard wire

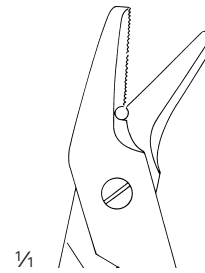

one toothed cutting edge



OF 206-14

14,5 cm / 5 ⁶/₈"

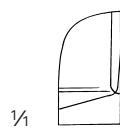

for soft wires up to
Ø 1,5 mm
for hard wires up to
Ø 1,0 mm



1/2

OF 207-14
14,5 cm / 5 7/8"

Cutting width
18 mm
for soft wires up to
∅ 2,0 mm
for hard wires up to
∅ 1,2 mm



1/2

OF 208-22
22 cm / 8 3/4"

for soft wires up to
∅ 3,0 mm
for hard wires up to
∅ 2,0 mm



1/2

OF 213-18
18 cm / 6 7/8"

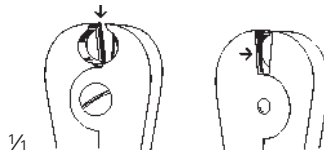

1/4

for soft wires up to
∅ 2,0 mm
for hard wires up to
∅ 1,5 mm



Bone and Traumatology Instruments

Wire Cutting Pliers



1/4
for soft wires up to
Ø 2,0 mm
for hard wires up to
Ø 1,7 mm

1/2

OF 214-17
17,5 cm / 6 7/8"

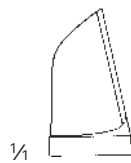

1/4
for soft wires up to
Ø 3,0 mm
for hard wires up to
Ø 2,2 mm



1/2

OF 215-23
23,5 cm / 9 2/8"



1/2

OF 216-23
23,5 cm / 9 2/8"

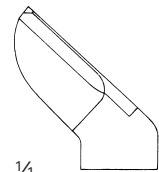

1/4
for soft wires up to
Ø 2,8 mm
for hard wires up to
Ø 2,2 mm



for wires up to
Ø 6,0 mm



OF 205-47
47 cm / 18 1/2"

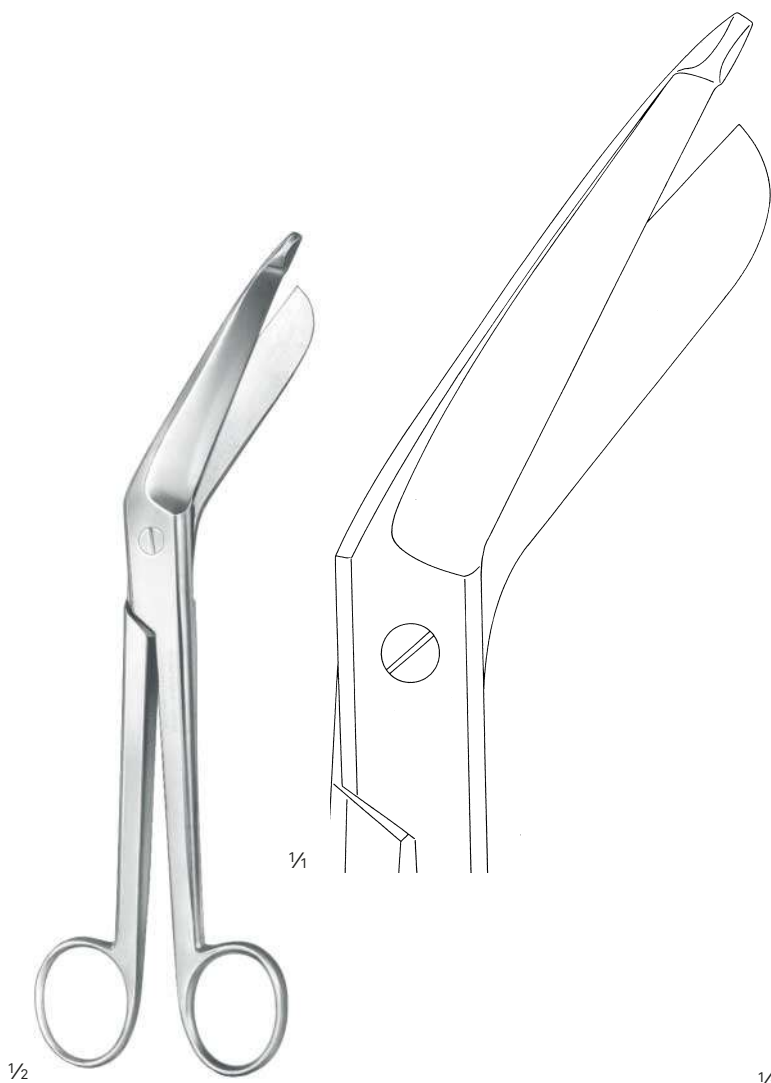
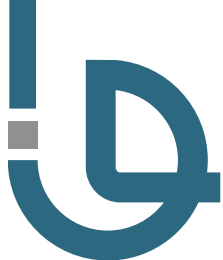

Bergmann
MA 620-23
23 cm / 9"
heavy pattern



Esmarch
MA 637-20
20 cm / 7 7/8"
heavy pattern, short blades

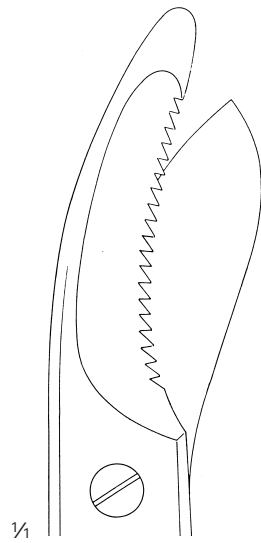

MA 640-24
one toothed cutting edge



MA 641-24



$\frac{1}{2}$

Brun's
24 cm / 9 $\frac{4}{8}$ "



Bone and Traumatology Instruments

Plaster Spreaders, Plaster Shears

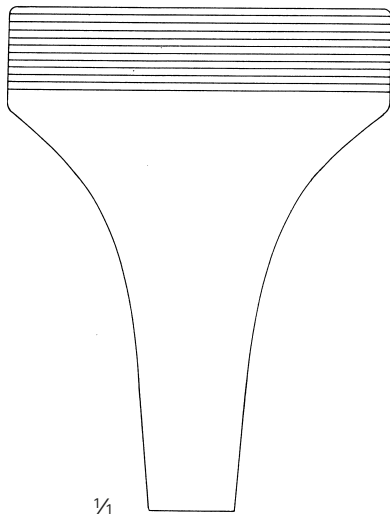

OF 200-27
27 cm / 10 ⁵/₈"

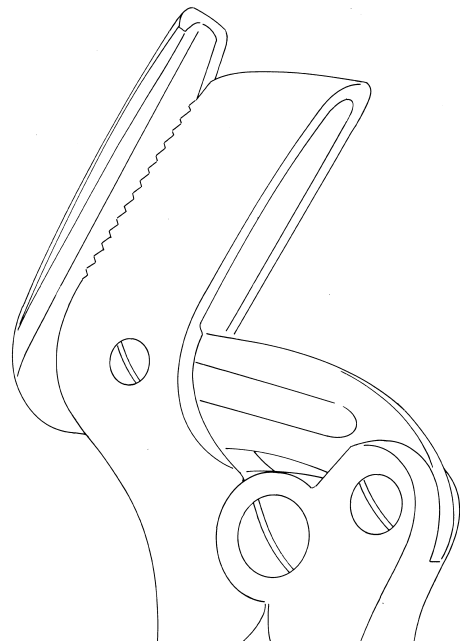

OF 204-37
37 cm / 14 ¹/₈"



Hennig



Stille-Martin

Suction Tubes





Suction Tubes

Suction Tubes

| | working length | tube diameter |
|------------------|----------------|---------------|
| AS 100-04 | 110 mm | Ø1,5 mm |
| AS 100-06 | 110 mm | Ø2,0 mm |
| AS 100-08 | 110 mm | Ø2,5 mm |
| AS 100-10 | 110 mm | Ø3,0 mm |
| AS 100-12 | 110 mm | Ø4,0 mm |
| AS 100-15 | 110 mm | Ø5,0 mm |
| | | |
| AS 101-04 | 130 mm | Ø1,5 mm |
| AS 101-06 | 130 mm | Ø2,0 mm |
| AS 101-08 | 130 mm | Ø2,5 mm |
| AS 101-10 | 130 mm | Ø3,0 mm |
| AS 101-12 | 130 mm | Ø4,0 mm |
| AS 101-15 | 130 mm | Ø5,0 mm |
| | | |
| AS 102-04 | 160 mm | Ø1,5 mm |
| AS 102-06 | 160 mm | Ø2,0 mm |
| AS 102-08 | 160 mm | Ø2,5 mm |
| AS 102-10 | 160 mm | Ø3,0 mm |
| AS 102-12 | 160 mm | Ø4,0 mm |
| AS 102-15 | 160 mm | Ø5,0 mm |
| | | |
| AS 103-04 | 200 mm | Ø1,5 mm |
| AS 103-06 | 200 mm | Ø2,0 mm |
| AS 103-08 | 200 mm | Ø2,5 mm |
| AS 103-10 | 200 mm | Ø3,0 mm |
| AS 103-12 | 200 mm | Ø4,0 mm |
| AS 103-15 | 200 mm | Ø5,0 mm |



Fergusson



1/2

Frazier

19,5 cm / 7 5/8"

AS 120-15
AS 120-20
AS 120-25
AS 120-30
AS 120-35
AS 120-40
AS 120-50

| | working length | tube diameter |
|-----------|----------------|---------------|
| AS 120-15 | 130 mm | Ø1,5 mm |
| AS 120-20 | 130 mm | Ø2 mm |
| AS 120-25 | 130 mm | Ø2,5 mm |
| AS 120-30 | 130 mm | Ø3,0 mm |
| AS 120-35 | 130 mm | Ø3,5 mm |
| AS 120-40 | 130 mm | Ø4,0 mm |
| AS 120-50 | 130 mm | Ø5,0 mm |



1/2

Ø4 mm

Fergusson

AS 250-12

18 cm / 7"



1/2

Plester

19,5 cm / 7 5/8"

AS 200-15
AS 200-20
AS 200-25
AS 200-30

Ø1,5 mm
Ø2,0 mm
Ø2,5 mm
Ø3,0 mm



1/2

Frazier

AS 201-02
AS 201-03
AS 201-04
AS 201-05

| | working length | tube diameter |
|-----------|----------------|---------------|
| AS 201-02 | 90 mm | Ø2,0 mm |
| AS 201-03 | 90 mm | Ø3,0 mm |
| AS 201-04 | 90 mm | Ø4,0 mm |
| AS 201-05 | 90 mm | Ø5,0 mm |

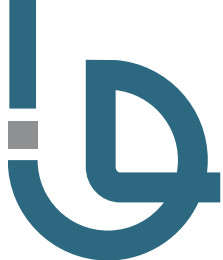

Suction Tubes

Suction Tubes



Eicken-Killian
14 cm / 5 4/8"
with Luer-Lock

- 1/4
- Ø 1,5 mm
AS 115-15
 - Ø 2,5 mm
AS 115-25
 - Ø 3,0 mm
AS 115-30



Fergusson
18,5 cm / 7"

- AS 110-45** Ø4,5 mm
- AS 110-55** Ø5,5 mm



1/2

Baron

- AS 270-01
- AS 270-02
- AS 270-03

| | working length | tube diameter |
|-----------|----------------|---------------|
| AS 270-01 | 75 mm | Ø1,0 mm |
| AS 270-02 | 75 mm | Ø1,5 mm |
| AS 270-03 | 75 mm | Ø2,0 mm |



1/2

Luer



1/4

Ø3,0 mm
AS 111-30
16,5 cm / 6 4/8"
working length
110 mm

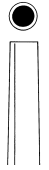

Ø3,5 mm
AS 111-35
16,5 cm / 6 4/8"
working length
110 mm



1/2

AS 310-01

AS 310-00
complete, 1 handle 4 tips



1/2

- AS 310-02 Ø0,5 mm
- AS 310-03 Ø0,7 mm
- AS 310-04 Ø1,0 mm
- AS 310-05 Ø1,3 mm



1/2

House
AS 311-05
4,5 cm / 1 6/8"
Suction adapter



- AS 310-03
- AS 310-04
- AS 310-05



Suction Tubes

Suction Tubes



Ø2,3 mm
Wullstein
AS 300-00
14 cm / 5 1/4" ^a
Complete, with handle and 3 tips



4,5 cm / 1 5/8" ^a
Micro suction cannula



AS 300-00
AS 300-01

AS 300-02
AS 300-03
AS 300-04

tube diameter

Ø0,4 mm
Ø0,6 mm
Ø0,8 mm



Ø2,5 mm
Wullstein
AS 300-01
14 cm / 5 1/4" ^a
Handle with tube, only

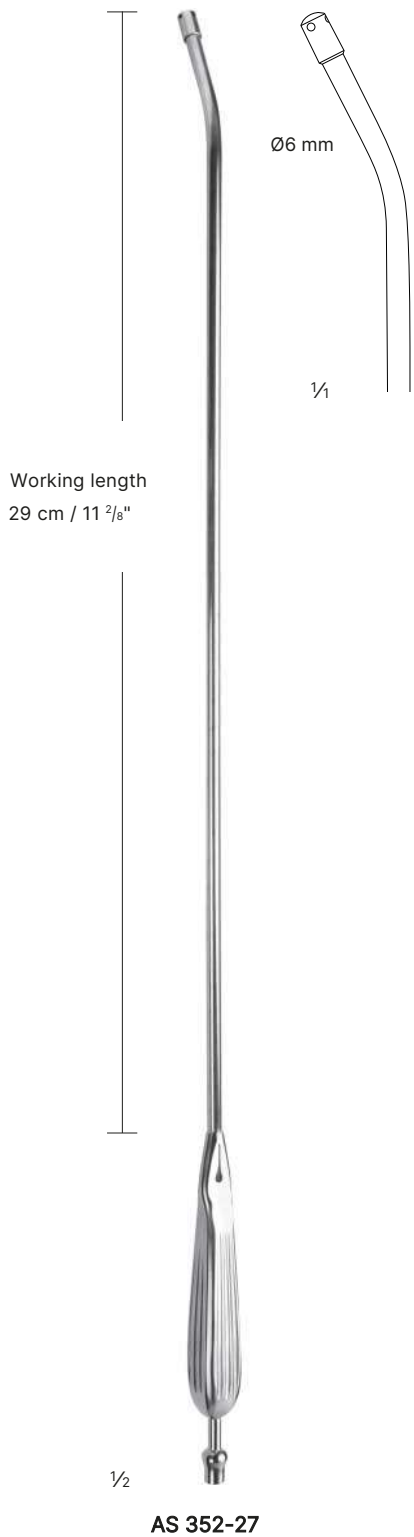



Suction Tubes

Suction Tubes



Ø10 mm
AS 356-28
28,5 cm / 11 1/8"



1/2
Ø10 mm
Yankauer
AS 355-27
27 cm / 10 5/8"
complete, with suction
tip and connector



1/2

Poole
AS 360-01
24 cm / 9 4/8"
Ø10 mm



1/2

Poole
AS 360-02
24 cm / 9 4/8"
Ø8 mm

Otology and Micro Ear Surgery Instruments

Ear Speculas
Tuning Forks
Tympanum Perfarators
Ear Curettes
Ear Lopps
Foreign Body Lever
Ear Hooks
Ear Forceps
Ear Polypus Forceps
Micro Ear Forceps
Micro Ear Needles
Micro Ear Knives
Micro Ear Needles
Micro Ear Periosteal Elevator
Micro Measuring Probes
Micro Ear Dissector





1/2

Hartmann

1/4 ○

Ø2,0 mm

KB 131-01

○

Ø3,0 mm

KB 131-02

○

Ø4,0 mm

KB 131-03

KB 131-00

Hartmann Ear
Speculum Set pieces 3

KB 131-01

KB 131-02

KB 131-03



1/2

Hartmann

1/4 ○

Ø3,5 mm

KB 130-01

○

Ø5,0 mm

KB 130-02

○

Ø6,0 mm

KB 130-03

○

Ø7,5 mm

KB 130-04

KB 130-00

Hartmann Ear
Speculum Set pieces 3

KB 130-01

KB 130-02

KB 130-03

KB 130-04



1/2
Hartmann
DP 100-01
C 128



1/2
Hartmann
DP 100-02
C1 256



1/2
Hartmann
DP 100-03
C2 512



1/2
Hartmann
DP 100-04
C3 1024



1/2
Hartmann
DP 100-05
C4 2048



1/2
Hartmann
DP 100-06
C5 4096

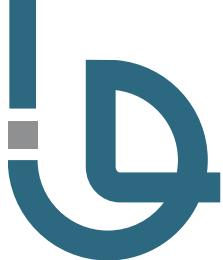

$\frac{1}{2}$
Politzer
BS 500-16
16,5 cm / 6 $\frac{1}{8}$ "
sickle



$\frac{1}{2}$
Politzer
BS 502-16
16 cm / 5 $\frac{7}{8}$ "
needle vertically



$\frac{1}{2}$
Politzer
BS 503-17
16 cm / 6 $\frac{2}{8}$ "
needle horizontally



$\frac{1}{2}$
Lucae
BS 501-18
18 cm / 7 $\frac{1}{8}$ "
needle vertically



$\frac{1}{2}$
Lucae
BS 501-19
18 cm / 7 $\frac{1}{8}$ "
needle horizontally

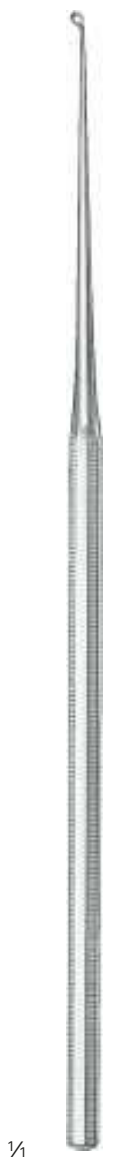

1/1

Buck
15 cm / 6 5/8"

blunt

1/1

| | | | |
|------------------|---------|---------|---|
| DP 141-01 | Fig.000 | Ø1,5 mm | ○ |
| DP 141-02 | Fig.00 | Ø2,0 mm | ○ |
| DP 141-03 | Fig.0 | Ø2,5 mm | ○ |
| DP 141-04 | Fig.1 | Ø3,0 mm | ○ |
| DP 141-05 | Fig.2 | Ø3,5 mm | ○ |
| DP 141-06 | Fig.3 | Ø4,0 mm | ○ |
| DP 141-07 | Fig.4 | Ø4,5 mm | ○ |

sharp

| | | | |
|------------------|---------|---------|---|
| DP 130-01 | Fig.000 | Ø1,5 mm | ○ |
| DP 130-02 | Fig.00 | Ø2,0 mm | ○ |
| DP 130-03 | Fig.0 | Ø2,5 mm | ○ |
| DP 130-04 | Fig.1 | Ø3,0 mm | ○ |
| DP 130-05 | Fig.2 | Ø3,5 mm | ○ |
| DP 130-06 | Fig.3 | Ø4,0 mm | ○ |
| DP 130-07 | Fig.4 | Ø4,5 mm | ○ |

straight blunt

| | | | |
|------------------|--------|---------|---|
| DP 140-02 | Fig.00 | Ø2,0 mm | ○ |
| DP 140-03 | Fig.0 | Ø2,5 mm | ○ |
| DP 140-04 | Fig.1 | Ø3,0 mm | ○ |
| DP 140-05 | Fig.2 | Ø3,5 mm | ○ |

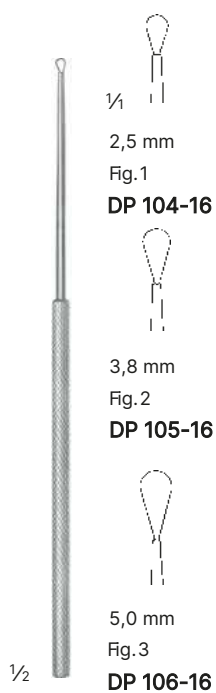

Billeau
16,5 cm / 6 4/8"

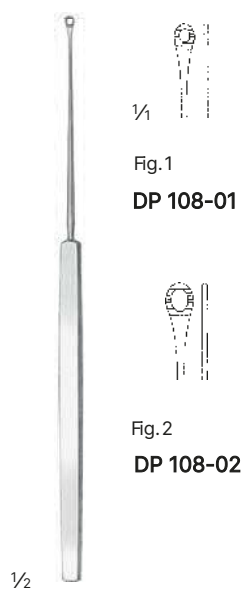

Shapleigh
15 cm / 5 7/8"



Zaufal
DP 113-01
15 cm / 5 7/8"
Foreign Body Lever



Lucae
14 cm / 5 4/8"



Wagener
14 cm / 5 4/8"

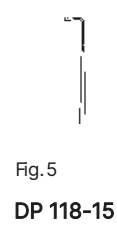
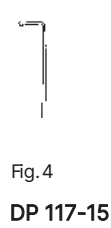
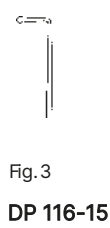
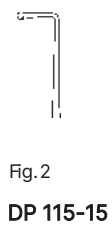
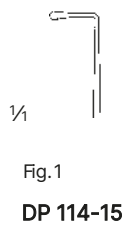



Troeltsch (Wilde)
FO 700-11
10,5 cm / 4 1/8"



Troeltsch (Wilde)
FO 700-12
11 cm / 4 3/8"

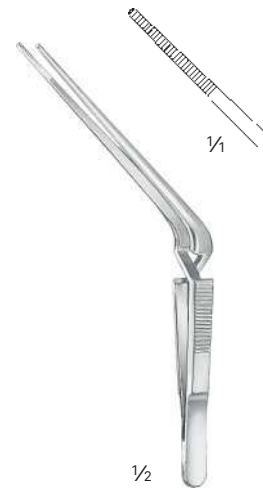

Troeltsch (Wilde)
FO 702-13
12,5 cm / 4 7/8"



Gruenwald
FO 703-14
14,5 cm / 5 6/8"



Jansen

16 cm / 6 2/8"
FO 705-16
18 cm / 7"
FO 705-18
21,5 cm / 8 4/8"
FO 705-20

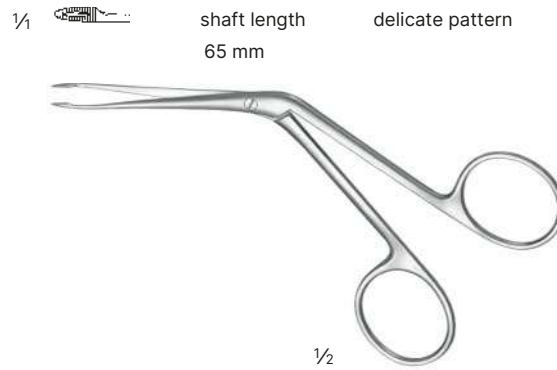

Hartmann
KB 184-01

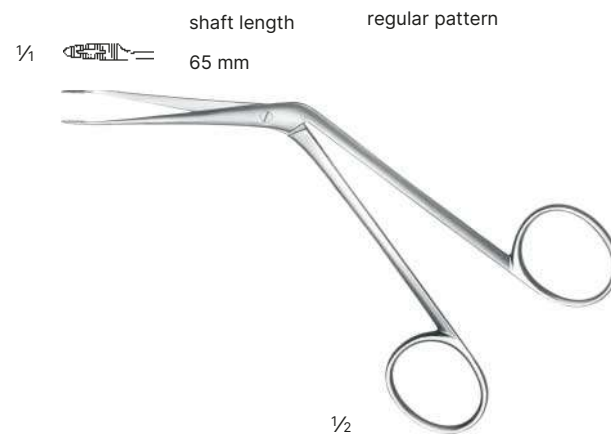

Hartmann
KB 184-02



Otology and Micro Ear Surgery Instruments

Micro Ear, Forceps

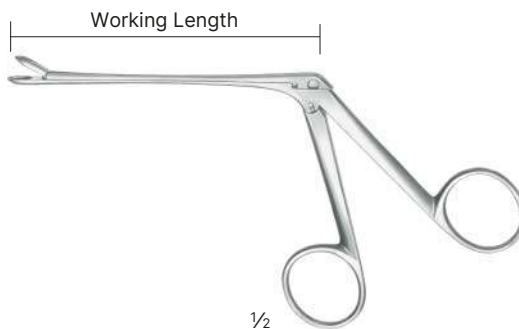

| | | | | |
|-----------------|--------------------|------------------|-------------------------------------|------------------|
| | 8mmx1.8mm | 8mmx1mm | 1x2 toothed 8mmx1mm | 8mmx1.8mm |
| 1/4 | | | | |
| | Hartmann | Hartmann | Hartmann | Hartmann |
| Working Length: | 8,5 cm | 8,5 cm | 8,5 cm | 14 cm |
| | KB 111-08 | KB 101-08 | KB 102-06 | KB 108-19 |
| | | | | |
| 1/4 | | ∅ 2,0 mm | ∅ 2,5 mm | ∅ 3,0 mm |
| | Hartmann | Hartmann | Hartmann | Hartmann |
| Working Length: | 8,5 cm | 8,5 cm | 8,5 cm | 8,5 cm |
| | KB 112-01 | KB 103-02 | KB 105-02 | KB 106-03 |
| | | | | |
| 1/4 | ∅ 3,0 mm | | ∅ 2,0 mm | |
| | Hartmann-Wullstein | Struempel | Hartmann-Hoffmann | Hartmann |
| Working Length: | 8,5 cm | 8,5 cm | 8,5 cm | 8,5 cm |
| | KB 107-03 | KB 113-01 | KB 112-02 through-cutting | KB 104-07 |

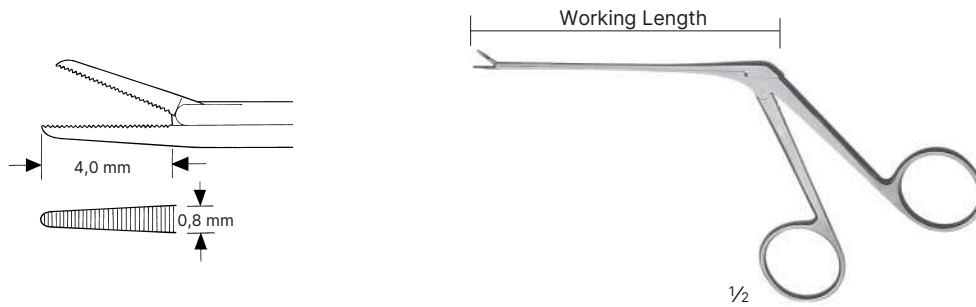

| | straight, serrated | bent upwards, serrated | right, serrated | left, serrated |
|-----------------|--------------------|------------------------|------------------|------------------|
| 1/4 | | | | |
| Working Length: | 8 cm | 8 cm | 8 cm | 8 cm |
| | KB 200-01 | KB 200-03 | KB 200-05 | KB 200-07 |

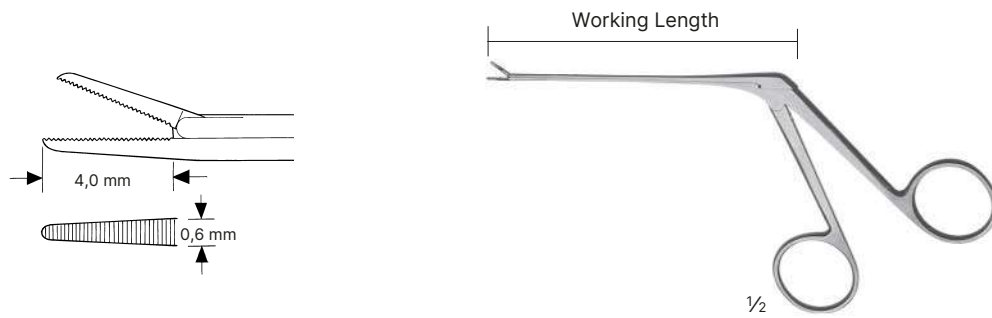

Working Length: 8 cm
KB 111-06

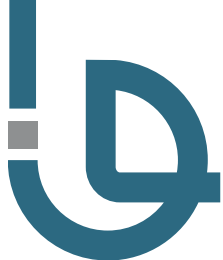

Otology and Micro Ear Surgery Instruments

Micro Ear Forceps

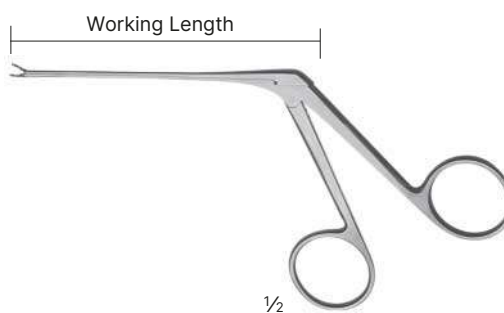
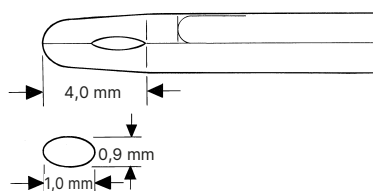

| cup | straight | bent upwards | right | left |
|-----------------|------------------|------------------|------------------|------------------|
| 1/4 | | | | |
| Working Length: | 8 cm | 8 cm | 8 cm | 8 cm |
| | KB 121-01 | KB 121-02 | KB 121-03 | KB 121-04 |

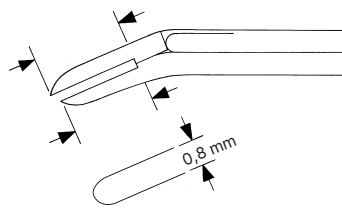

angled downward

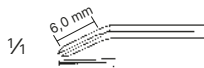

0,8 x 6 mm

Working Length: 8 cm

KB 121-06

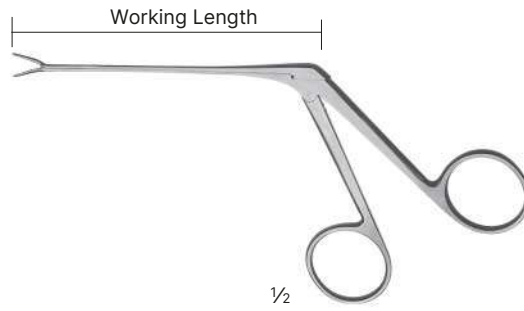

McGee

Wire Bending Forceps

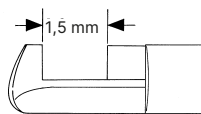

up-cutting



down-cutting



Working Length: 9 cm

KB 121-07

9 cm

KB 121-08

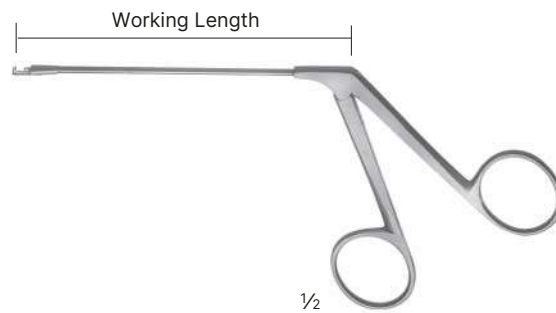

House-Dieter

Malleus Nipper

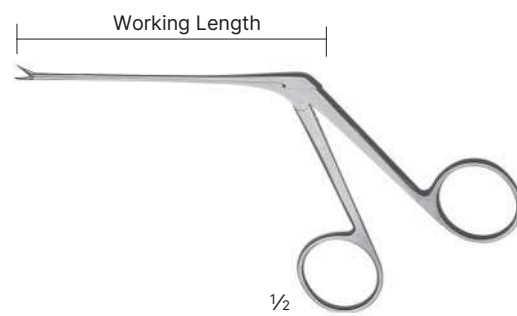
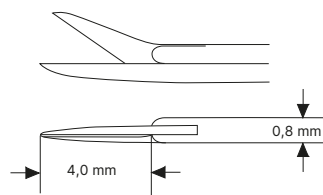

Bellucci

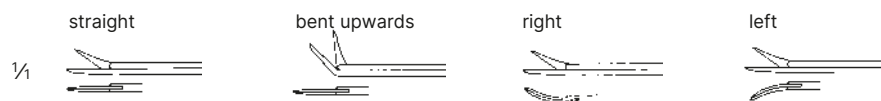

Working Length: 8 cm
KB 120-01

8 cm
KB 120-02

8 cm
KB 120-03

8 cm
KB 120-04

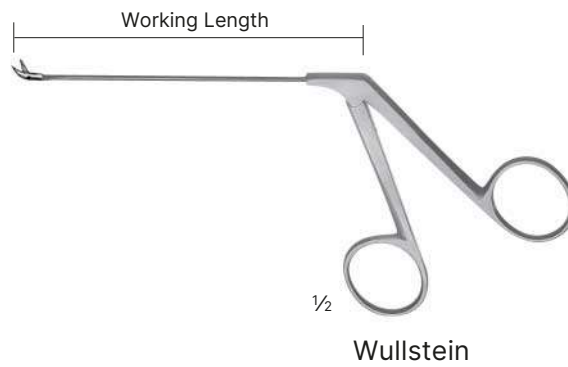
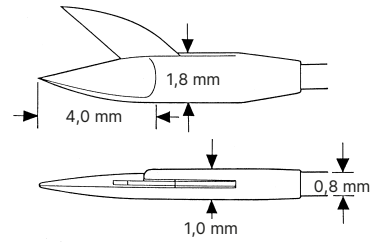

| | | | | |
|-----------------|------------------|------------------|------------------|------------------|
| | straight | bent upwards | right | left |
| 1/4 | | | | |
| Working Length: | 9 cm | 9 cm | 9 cm | 9 cm |
| | KB 202-01 | KB 202-02 | KB 202-03 | KB 202-04 |

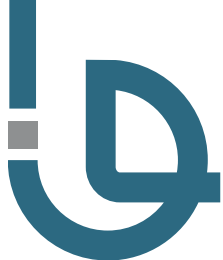

Otology and Micro Ear Surgery Instruments

Micro Ear Needles, Micro Ear Hooks

1/4



Barbara
HO 300-01



Barbara
HO 300-02



Barbara
HO 300-03



Rosen
HO 300-04



45°
hook

Barbara



90°
hook

Barbara



Barbara

| | |
|------------------|--------|
| HO 304-03 | 0,3 mm |
| HO 304-06 | 0,6 mm |
| HO 304-10 | 1,0 mm |
| HO 304-12 | 1,2 mm |
| HO 304-15 | 1,5 mm |
| HO 304-20 | 2,0 mm |
| HO 304-25 | 2,5 mm |

| | |
|------------------|--------|
| HO 305-03 | 0,3 mm |
| HO 305-06 | 0,6 mm |
| HO 305-10 | 1,0 mm |
| HO 305-12 | 1,2 mm |
| HO 305-15 | 1,5 mm |
| HO 305-20 | 2,0 mm |
| HO 305-25 | 2,5 mm |

| | |
|------------------|--------|
| HO 306-05 | 0,5 mm |
| HO 306-10 | 1,0 mm |

1/4

16 cm / 6 2/8"





Schuknecht
HO 310-04
 14,5 cm / 5 7/8"
 Sickle Knife



Wullstein
HO 310-06
 15,5 cm / 6 1/8"
 Sickle Knife



Tabb
HO 310-08
 15,5 cm / 6 1/8"
 Mucosa Knife



Plester
HO 310-10
 15 cm / 5 7/8"
 Flap Knife

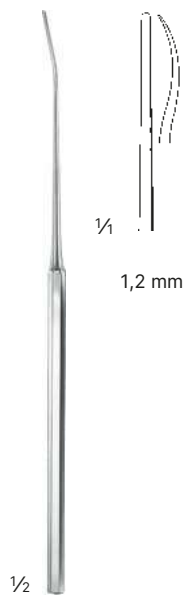

Rosen
HO 313-12
 15 cm / 5 7/8"
 Micro Ear Periosteal Elevator



Rosen
 15 cm / 5 7/8"

| | | | |
|------------------|-------|---------|--|
| HO 317-30 | Fig.1 | Ø3,0 mm | |
| HO 317-28 | Fig.2 | Ø2,8 mm | |
| HO 317-26 | Fig.3 | Ø2,6 mm | |
| HO 317-20 | Fig.4 | Ø2,0 mm | |
| HO 317-16 | Fig.5 | Ø1,6 mm | |
| HO 317-14 | Fig.6 | Ø1,4 mm | |
| HO 317-10 | Fig.7 | Ø1,0 mm | |



Otology and Micro Ear Surgery Instruments

Micro Measuring Probes, Micro Ear Hooks, Micro Ear Dissector



1/2

House

15,5 cm / 6 1/8"



1/4

HO 322-01

Marking up to
3,5 mm



HO 322-02

Marking up to
4,0 mm



HO 322-03

Marking up to
4,5 mm



1/2

Fisch



1/4

HO 347-01

15 cm / 5 7/8"
angled to right



HO 347-02

15 cm / 5 7/8"
angled to left



HO 346-01

15,5 cm / 6 1/8"
angled to right



HO 346-02

15,5 cm / 6 1/8"
angled to left



45°
Exploring Hook

2,0 mm
blunt

1/4

Shea

HO 332-20

15 cm / 5 7/8"



90°
Attic Dissector

3,0 mm
blunt

Austin

HO 333-30

15 cm / 5 7/8"



1/2

Barbara

15,5 cm / 6 1/8"

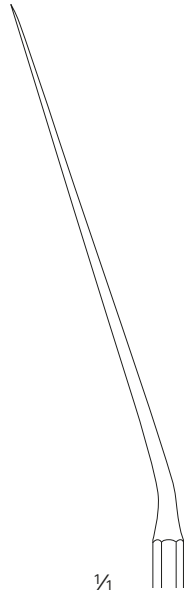

1/4

HO 360-01

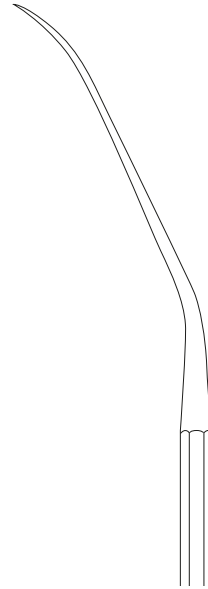

HO 360-02



1/2

15,5 cm / 6 1/8"



90°

angled upwards

1/4

- HO 361-03** 0,3 mm
- HO 361-06** 0,6 mm
- HO 361-10** 1,0 mm



90°

angled downwards

- HO 362-03** 0,3 mm
- HO 362-06** 0,6 mm
- HO 362-10** 1,0 mm



curved upwards

- HO 363-04** 0,5 mm
- HO 363-10** 1,0 mm



curved downwards

- HO 364-04** 0,5 mm
- HO 364-10** 1,0 mm



Otology and Micro Ear Surgery Instruments

Micro Ear Curettes



1/2

House

14,5 cm / 5 9/16"



Ø 1,0 mm



Ø 1,5 mm

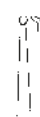

Ø 1,0 mm

Ø 1,2 mm



1/1

HO 365-02

Ø 1,8 mm



HO 365-03

Ø 1,2 mm

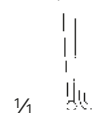

1/1

HO 365-04

Rhinology, Rinoplasty, Sinus and Hypophysectomy Instruments

Nasal Speculas
Nasal Forceps
Ethmoid Forceps
Nasal Cutting Forceps
Antrum Punches
Nasal Tampon Forceps
Septum Forceps
Septum Scissors
Nasal Scissors
Swivel Knives
Mucosa Knife
Rhinoplastic Knives
Septum Elevators
Ostium Seeker
Periosteal Elevators
Septum Chisels
Septum Gouges
Osteotomes
Rhinoplastic Chisels
Nasal Saws
Cartilage Crusher
Nasal Bone Files
Rasps
Nasal Hooks
Nasal Retractor



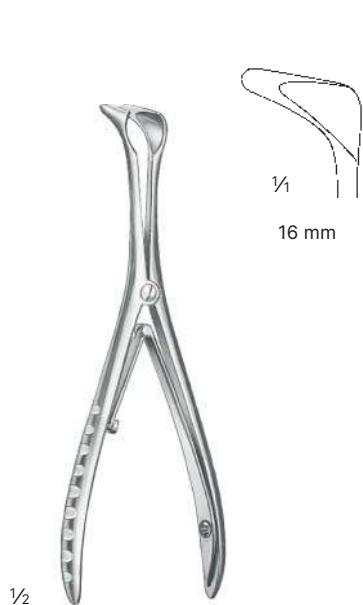

1/2

Tieck-Halle

KB 250-13

13 cm / 5 1/8"

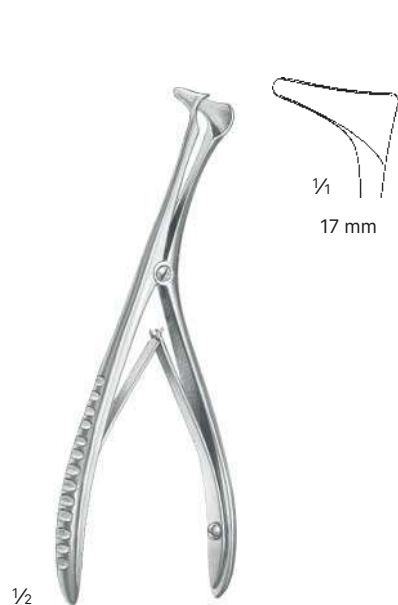

1/2

Beckmann

KB 255-14

13 cm / 5 1/8"

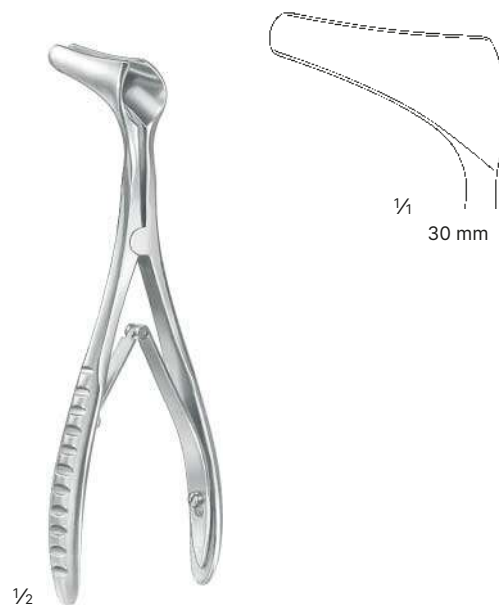

1/2

Mod. Wien

KB 259-14

13,5 cm / 5 3/8"



1/2

Hartmann-Halle

16 cm / 6 2/8"

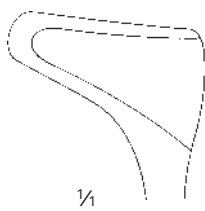

1/4

Fig.1

KB 250-16

27 mm

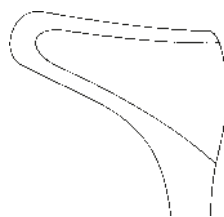

Fig.2

KB 251-16

31 mm

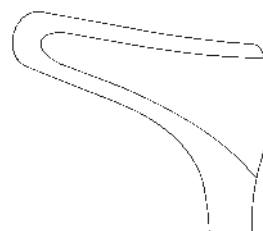

Fig.3

KB 252-16

35 mm



1/2

Killian

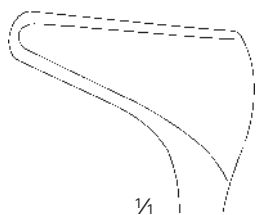

1/4

Fig.1

KB 260-01

14 cm / 5 4/8"

35 mm

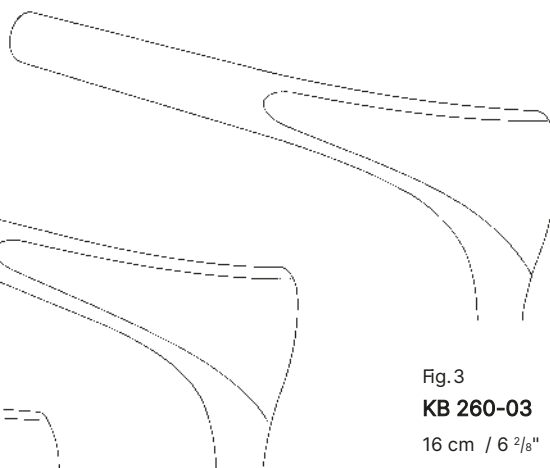

Fig.2

KB 260-02

14,5 cm / 5 9/8"

50 mm

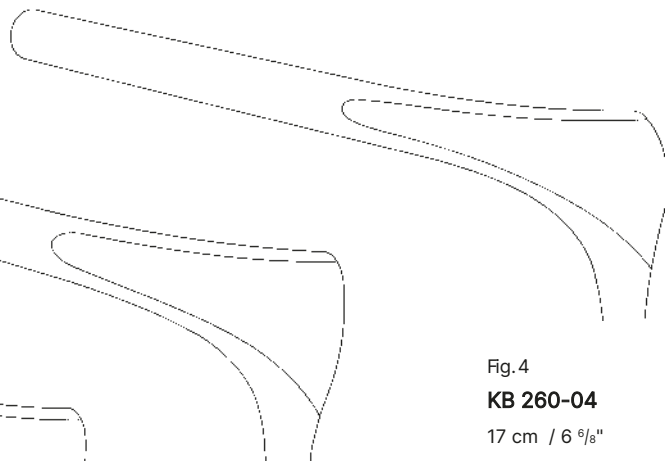

Fig.3

KB 260-03

16 cm / 6 2/8"

75 mm

Fig.4

KB 260-04

17 cm / 6 7/8"

85 mm

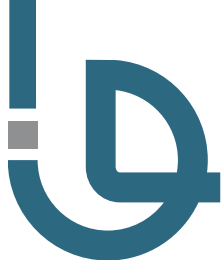

1/2

Cottle

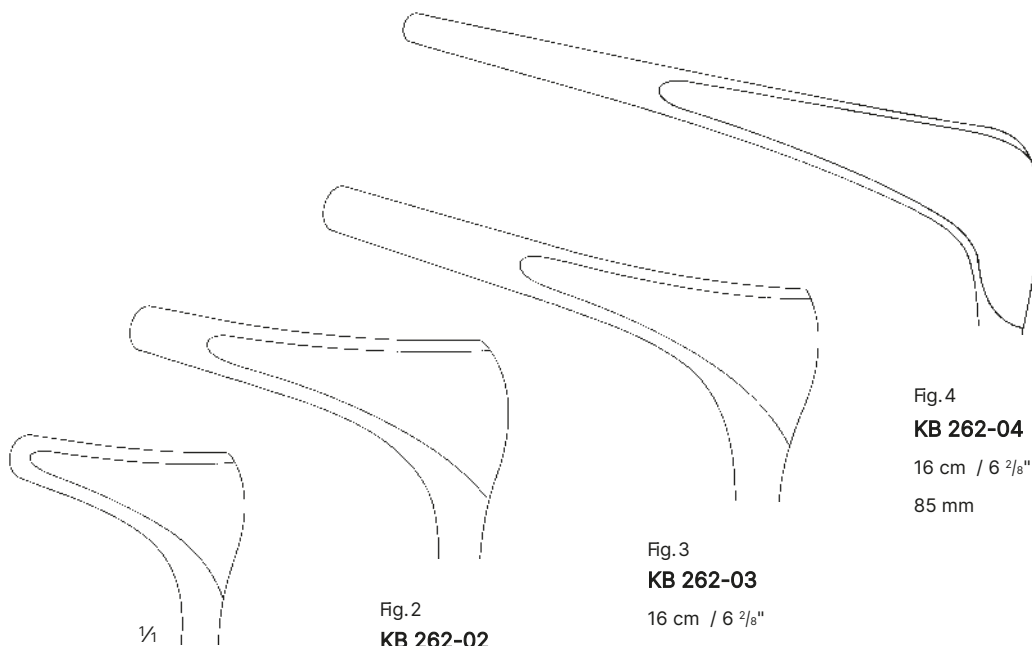
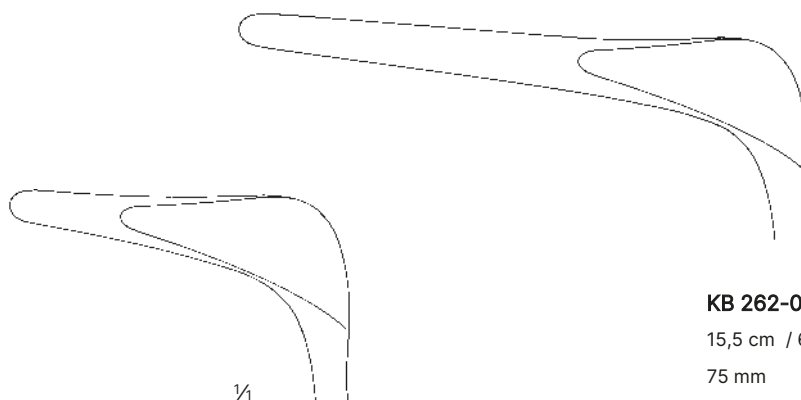

Fig.1
KB 262-01
13,5 cm / 5 3/8"
35 mm

Fig.2
KB 262-02
14 cm / 5 4/8"
50 mm

Fig.3
KB 262-03
16 cm / 6 2/8"
75 mm

Fig.4
KB 262-04
16 cm / 6 2/8"
85 mm



1/1

KB 262-05
14 cm / 5 4/8"
45 mm

KB 262-06
15,5 cm / 6 1/8"
75 mm

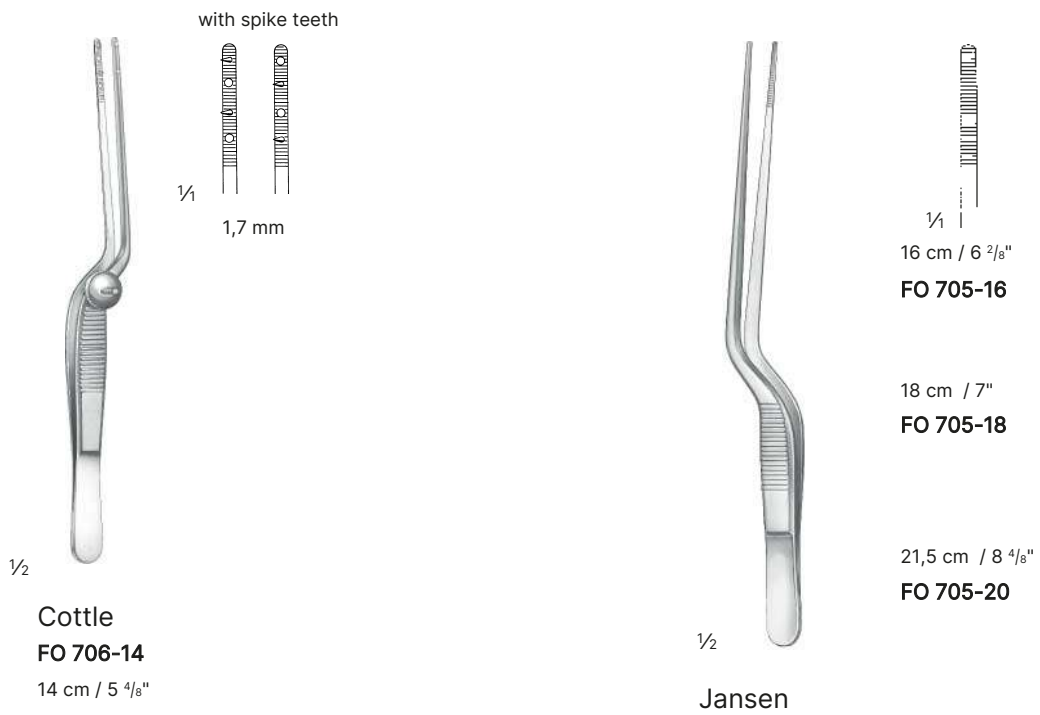
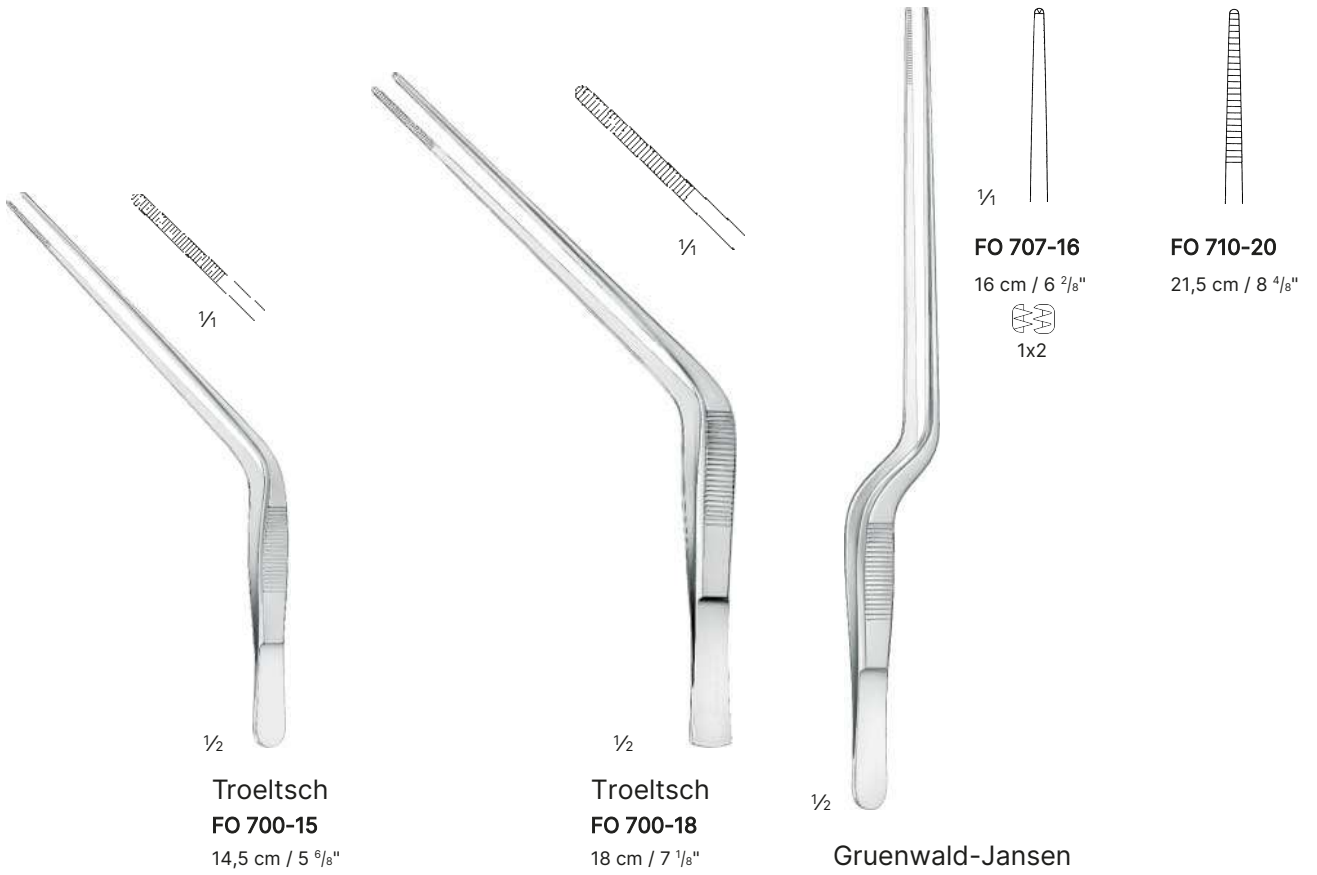

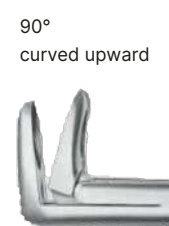
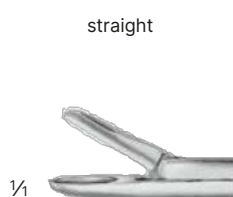
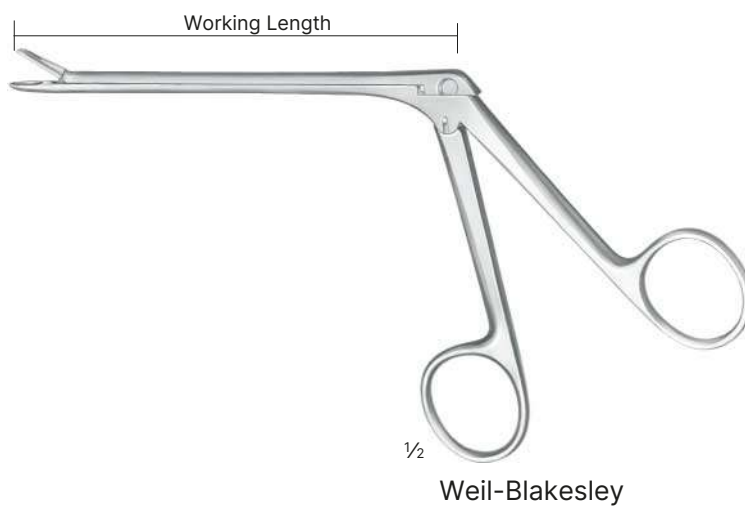

Jaw width

Working Length: 12 cm

Jaw width

Working Length: 12 cm

12 cm

Fig.1
3,0 mm



KB 450-01

Fig.1
3,0 mm



KB 451-01

KB 453-01

Fig.2
3,5 mm



KB 450-02

Fig.2
3,5 mm



KB 451-02

KB 453-02

Fig.3
4,5 mm



KB 450-03

Fig.3
4,5 mm



KB 451-03

KB 453-03

Fig.4
5,0 mm



KB 450-04

Fig.4
5,0 mm

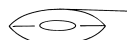

KB 452-01

KB 453-04

Fig.5
6,0 mm



KB 450-05

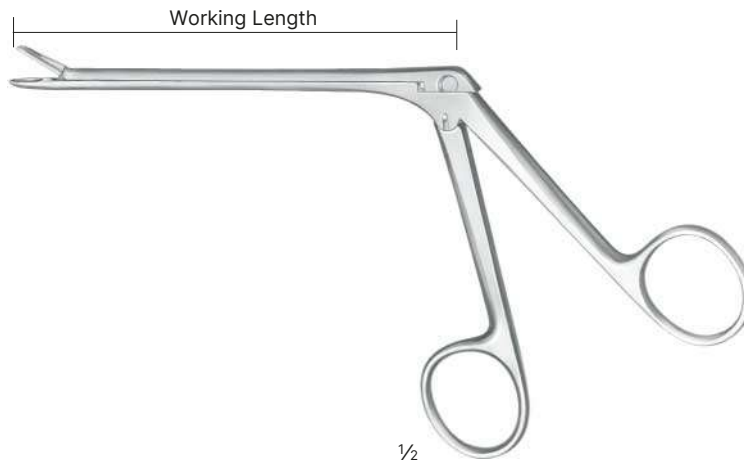

Watson-Williams

straight
Working Length: 12 cm



KB 432-01

Jaw width 7,0 mm

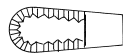

straight
12 cm



KB 432-02

8,0 mm

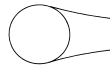

straight
12 cm



KB 432-03

5,5 mm

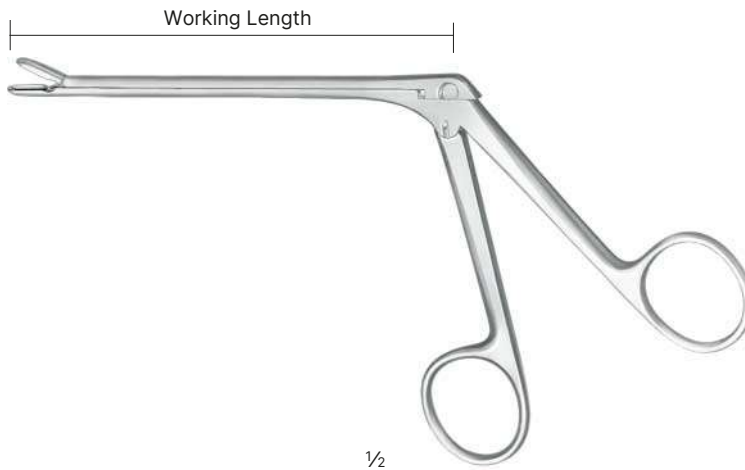

Takahashi

straight

1/4



Working Length: 12 cm

KB 433-01

Jaw width 3,5 mm



45°
angled upward



12 cm

KB 433-02

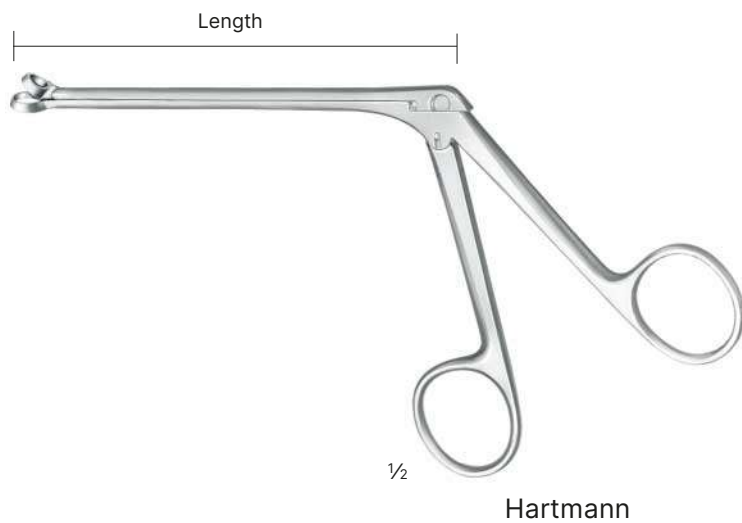

Hartmann

1/4



Hartmann

Length 12 cm

KB 437-01

8,0 mm



Schmieden

Length 12 cm

KB 438-01

Jaw width

Length

Fig.1
Ø 5,0 mm



Fig.2
Ø 7,0 mm



Fig.3
Ø 9,0 mm



Fig.4
Ø 11,0 mm



1/4



Struycken

Length 12 cm

KB 434-01

1,0 mm

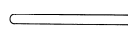

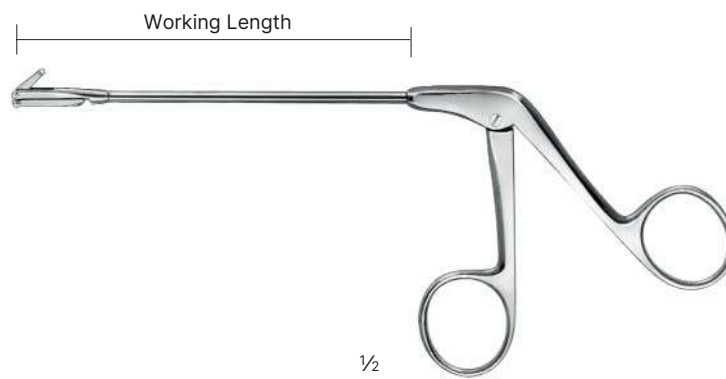

backbiting up

1/4



backbiting right



backbiting left



Jaw width
2,5 mm



Working Length: 10 cm

KB 800-01

10 cm

KB 800-02

10 cm

KB 800-03



Rhinology, Rhinoplasty, Sinus and Hypophysectomy Instruments

Nasal Tampon Forceps, Septum Forceps



Hartmann
KB 185-02
18,5 cm / 7 ²/₈"



Brünings
16,5 cm / 6 ⁴/₈"

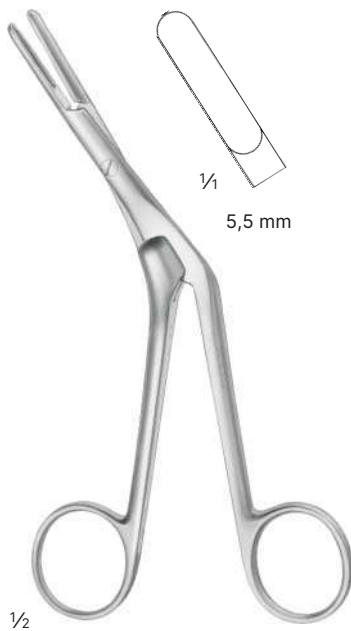
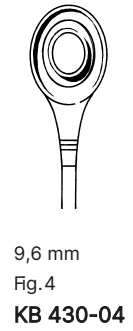
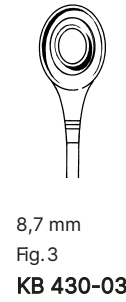
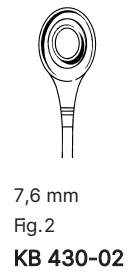
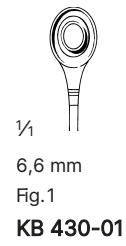

Graig
KB 428-01
16 cm / 6 ²/₈"

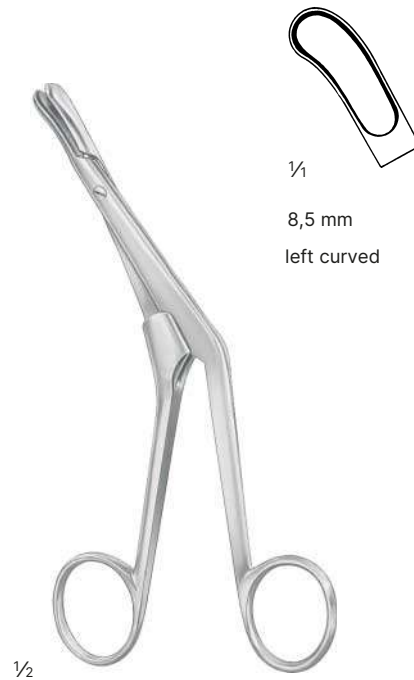

Graig
KB 428-02
15,5 cm / 6 ¹/₈"



Middleton-Jansen
KB 416-21
20,5 cm / 8 1/8"



Middleton-Jansen
KB 415-20
20 cm / 7 7/8"

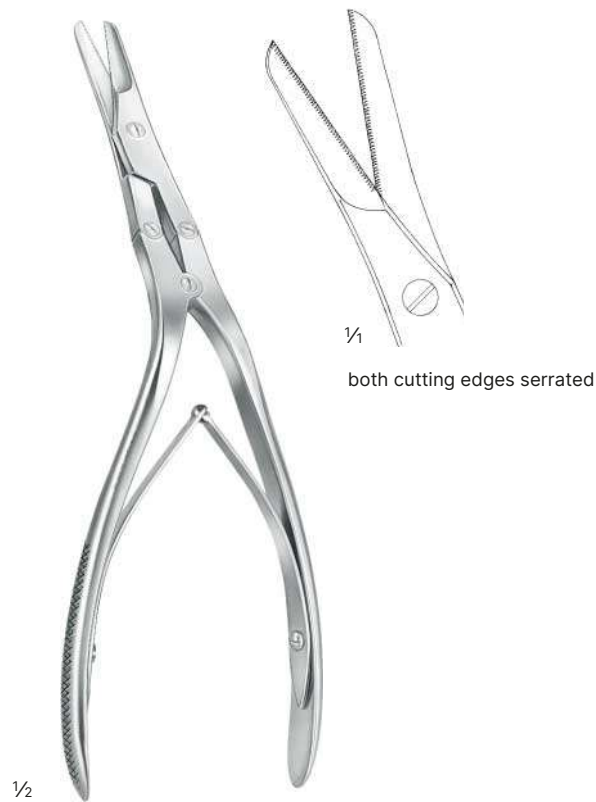

Caplan
MA 446-22
20 cm / 7 7/8"



1/2

Fomon

MA 447-13

13,5 cm / 5 2/8"

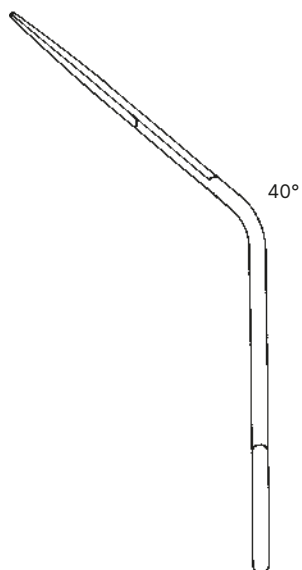

40°



1/2

Cottle

MA 450-16

16 cm / 6 2/8"

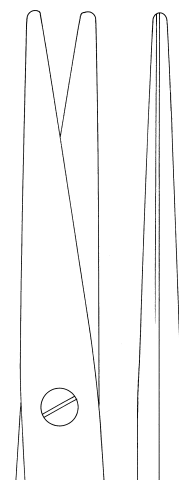

1/2

Heymann

18 cm / 7 1/8"

MA 451-18



1/4



1/2

Heymann

20 cm / 7 7/8"

MA 452-19



1/4



1/2

Ballenger
20 cm / 8 "



1/1

3 mm
KB 410-01

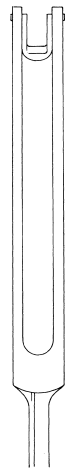

4 mm
KB 410-02

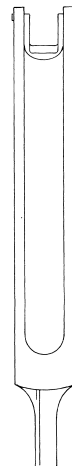

5 mm
KB 410-03



1/2

Ballenger
20,5 cm / 8 1/8 "

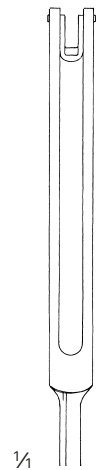

1/1

3 mm
KB 411-03



4 mm
KB 411-04

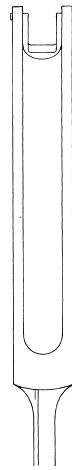

5 mm
KB 411-05

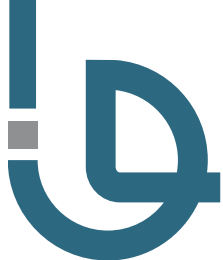

Freer
KB 350-15
15,5 cm / 6 1/8"
Mucosa Knife

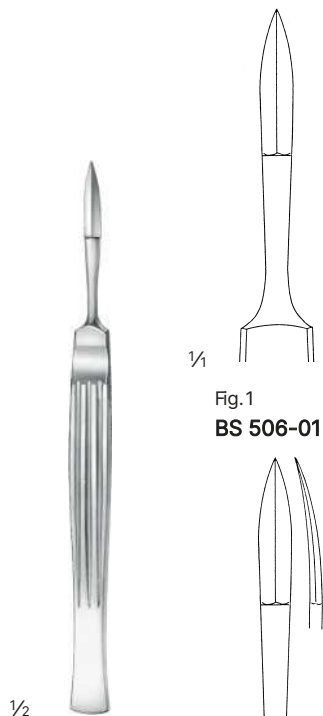
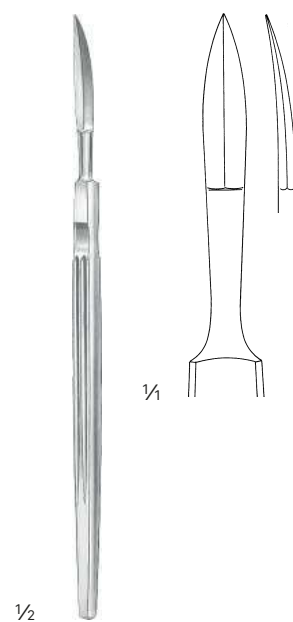

Fig.1
BS 506-01

Fig.2
BS 506-02

Joseph
15 cm / 5 7/8"



Fomon
BS 510-01
16,5 cm / 6 4/8"

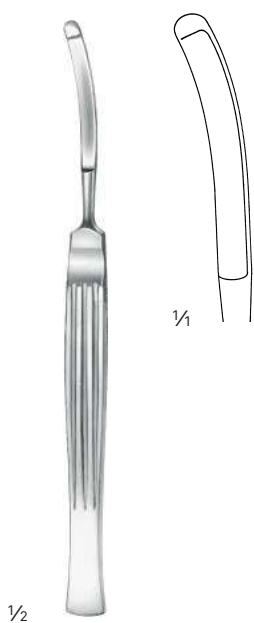

Converse
BS 508-01
16 cm / 6 2/8"

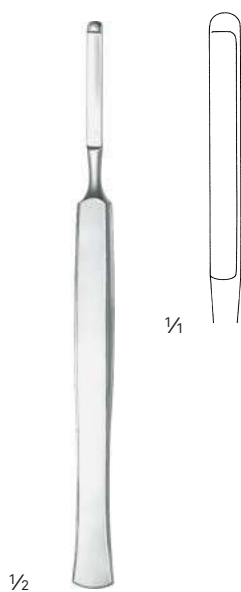

Joseph
BS 507-01
15,5 cm / 6 1/8"

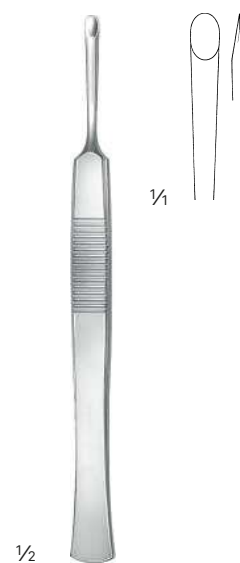

Cottle
BS 509-01
14 cm / 5 4/8"

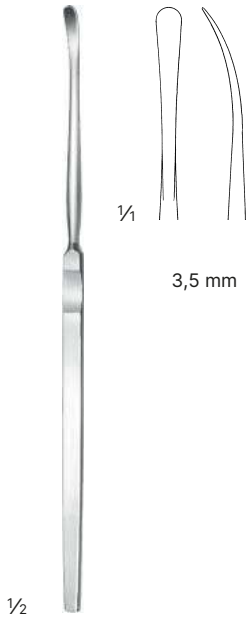

Halle
KB 350-18
 16 cm / 6 2/8"

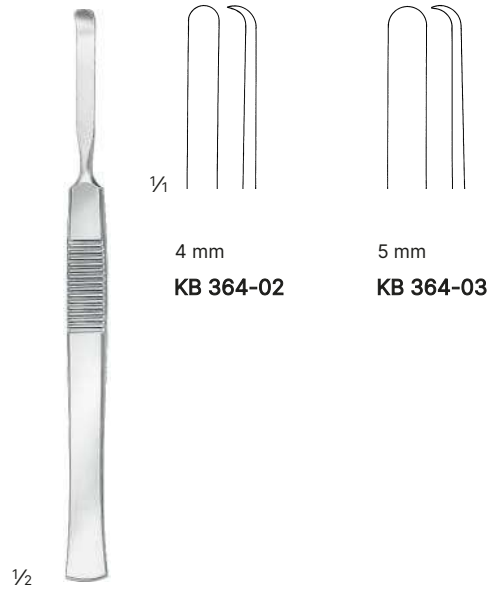

McKenty
 15 cm / 5 7/8"



Freer
 19 cm / 7 4/8"



5 mm
KB 351-19
 blunt

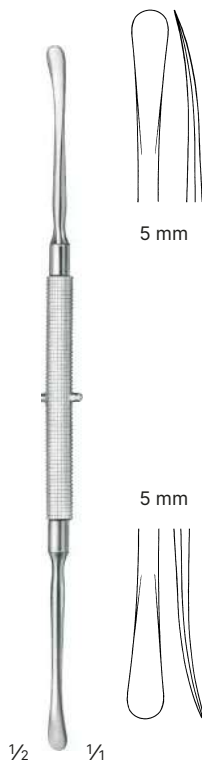

Freer
KB 353-18
 18 cm / 7 1/8"



5 mm

5 mm

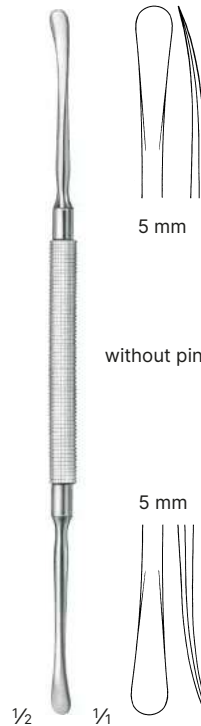

Freer
KB 354-18
 18 cm / 7 1/8"



5 mm

without pin in handle, sharp / blunt



Killian
KB 355-18
18 cm / 7 1/8"

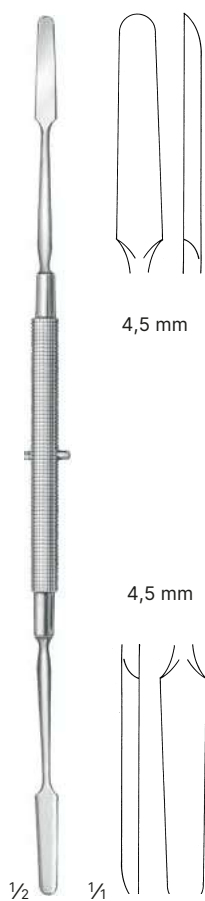

Killian
KB 359-18
23,5 cm / 9 2/8"

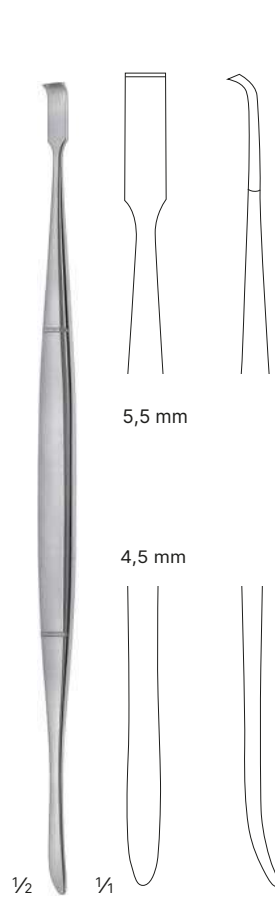

Howard
KB 362-21
21,5 cm / 8 4/8"

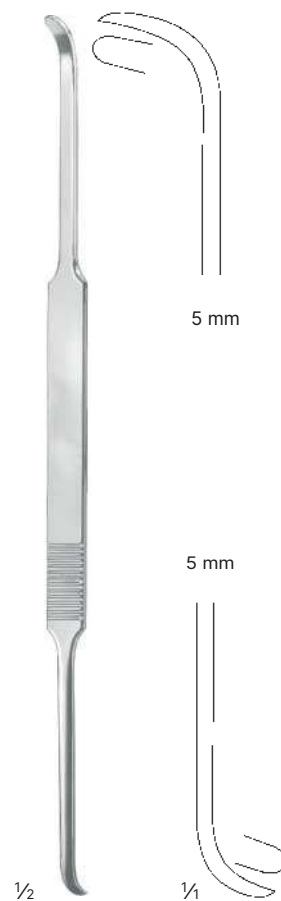

Cottle
KB 462-20
23,5 cm / 9 2/8"

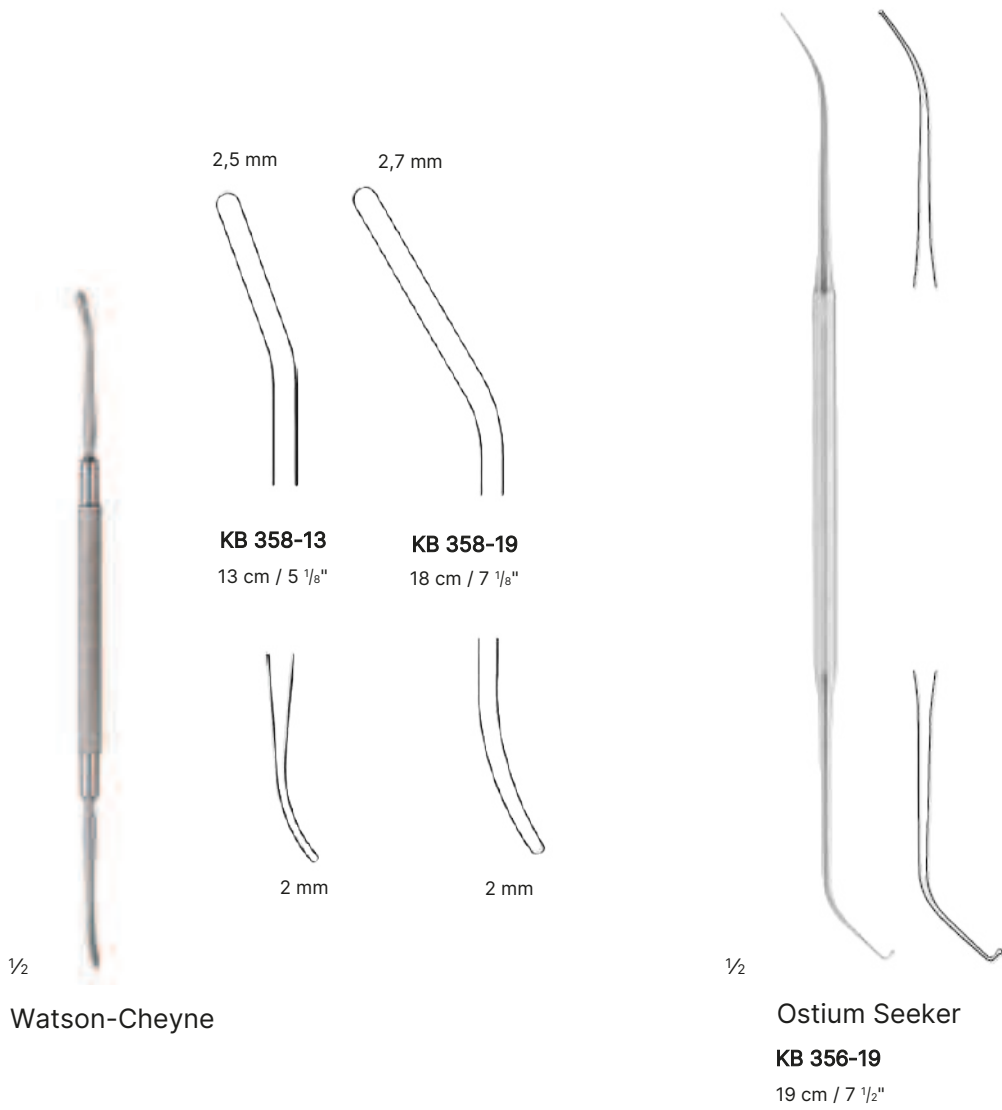

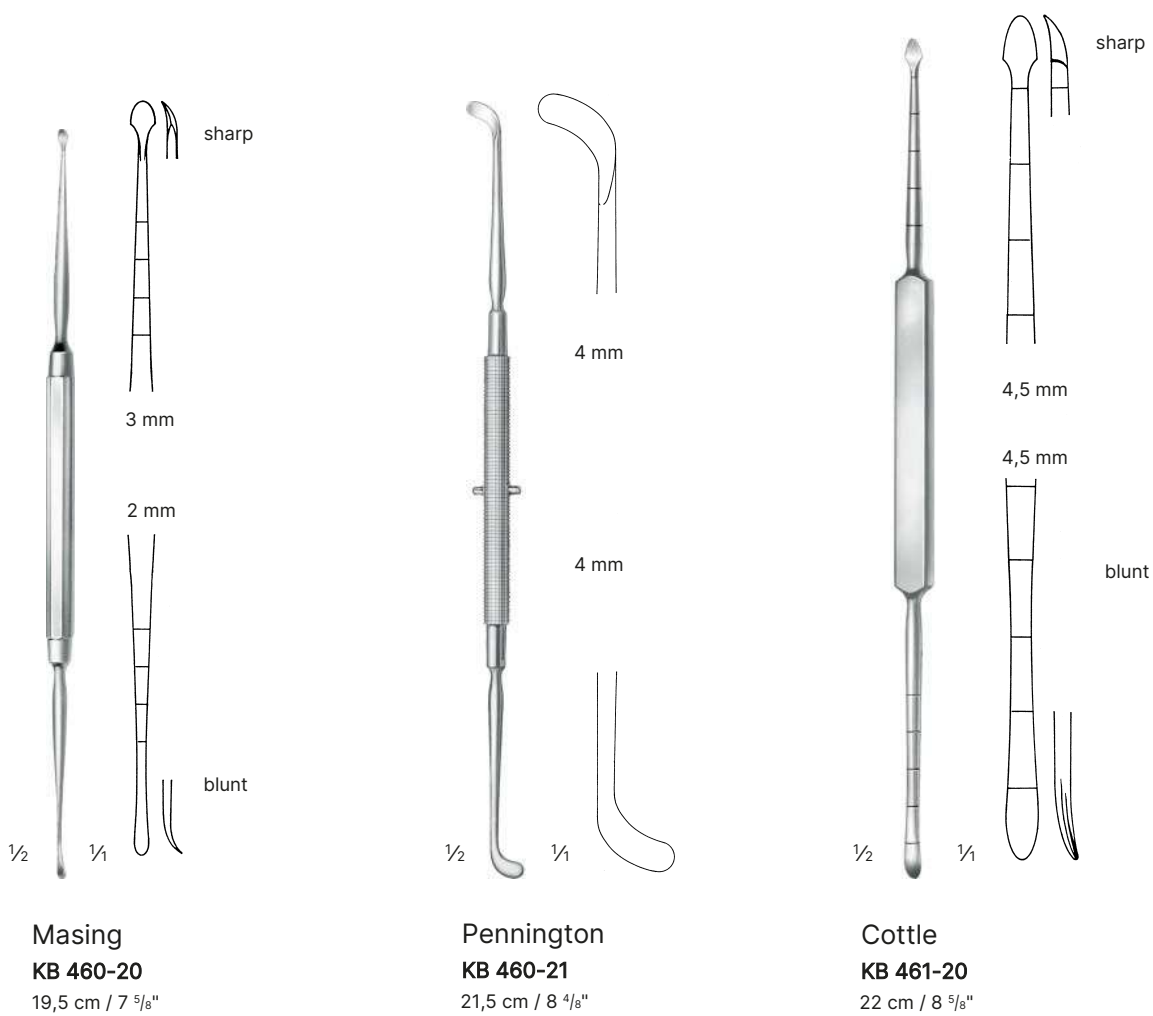



1/4
4 mm
KB 368-16

Freer
16,5 cm / 6 4/8"



4 mm
KB 367-16

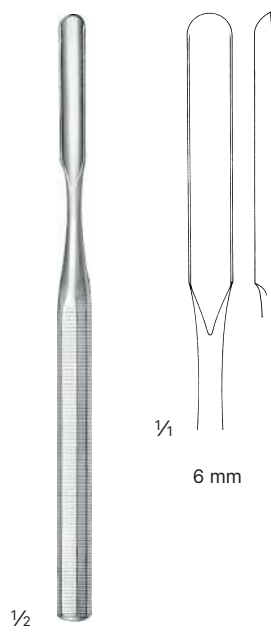

1/4
6 mm

Freer
KB 420-15
16 cm / 6 2/8"

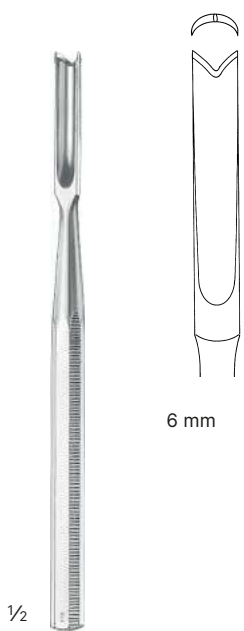

6 mm

Ballenger
KB 421-15
15 cm / 5 7/8"

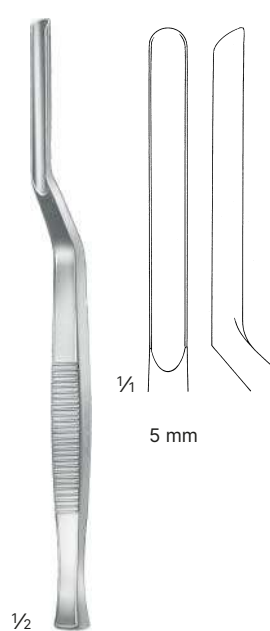

1/4
5 mm

Killian
KB 423-17
16 cm / 6 2/8"

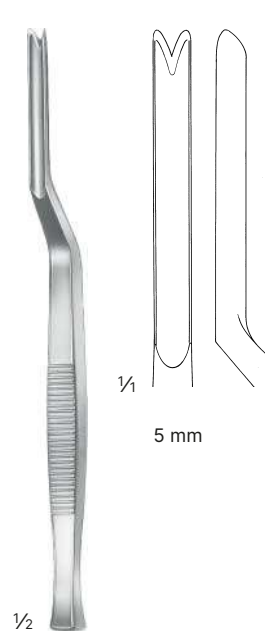

1/4
5 mm

Killian-Klaus
KB 422-17
16 cm / 6 2/8"



1/2

Cottle

18,5 cm / 7 2/8"

- | | |
|------------------|-------|
| KB 491-04 | 4 mm |
| KB 491-06 | 6 mm |
| KB 491-08 | 7 mm |
| KB 491-10 | 9 mm |
| KB 491-12 | 12 mm |



- | | |
|------------------|-------|
| KB 492-04 | 4 mm |
| KB 492-06 | 6 mm |
| KB 492-07 | 7 mm |
| KB 492-09 | 9 mm |
| KB 492-10 | 10 mm |
| KB 492-12 | 12 mm |



1/2

Cottle

KB 493-06
18,5 cm / 7 2/8"



6 mm



1/2

Cottle

18,5 cm / 7 2/8"



- | | |
|------------------|-------|
| KB 503-02 | 2 mm |
| KB 503-04 | 4 mm |
| KB 503-06 | 6 mm |
| KB 503-08 | 8 mm |
| KB 503-10 | 10 mm |
| KB 503-12 | 12 mm |



1/2

Cottle

KB 504-16
18,5 cm / 7 2/8"

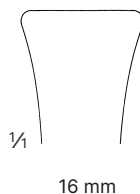

1/4

16 mm



1/2

Rubin

KB 505-14
18,5 cm / 7 2/8"



1/4

14 mm

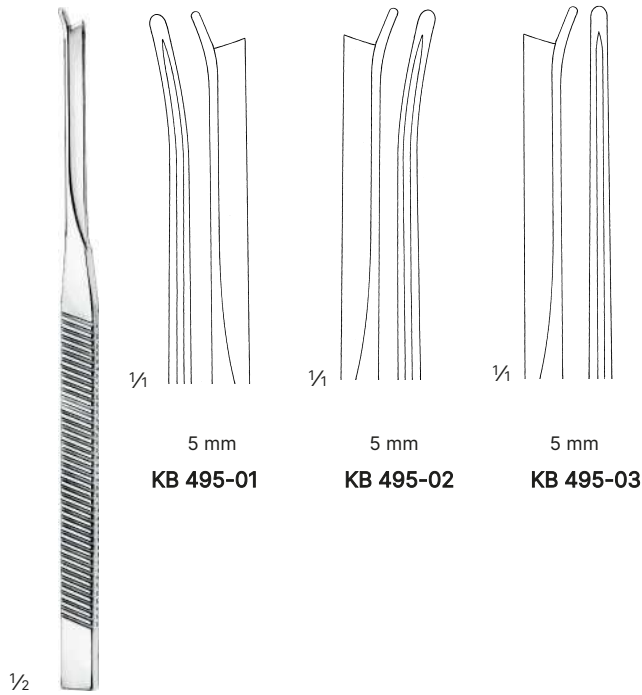

Silver-Masing

18 cm / 7 1/8"

5 mm
KB 495-01

5 mm
KB 495-02

5 mm
KB 495-03

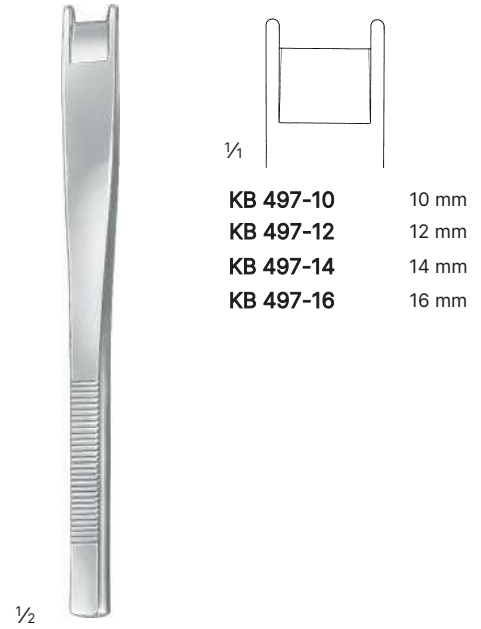

Cinelli

16 cm / 6 2/8"

KB 497-10 10 mm
KB 497-12 12 mm
KB 497-14 14 mm
KB 497-16 16 mm

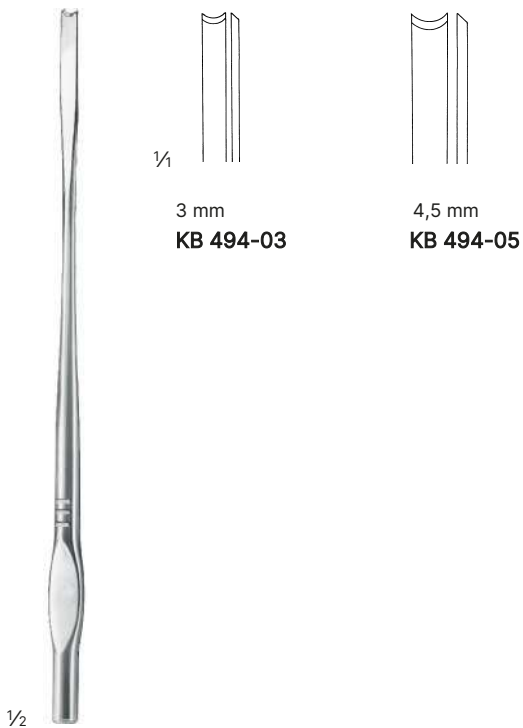

Walter

19 cm / 7 4/8"

3 mm
KB 494-03

4,5 mm
KB 494-05

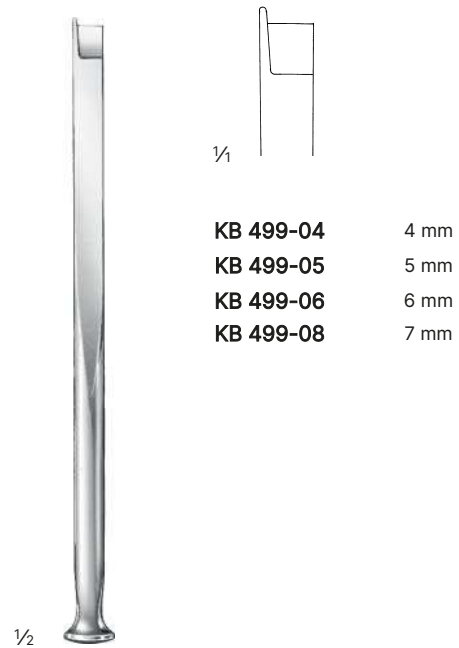

Fomon

16 cm / 6 2/8"

KB 499-04 4 mm
KB 499-05 5 mm
KB 499-06 6 mm
KB 499-08 7 mm

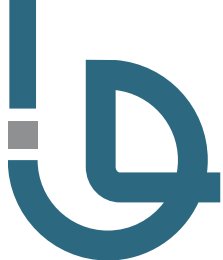

1/2

Joseph
19 cm / 7 4/8"

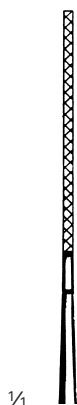

1/1

KB 558-01
working length
40 mm

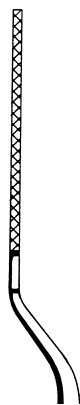

KB 558-03
working length
40 mm



KB 558-02
working length
40 mm



1/2

Cottle
KB 161-00
Cartilage Crusher
65 x 30 x 30 mm



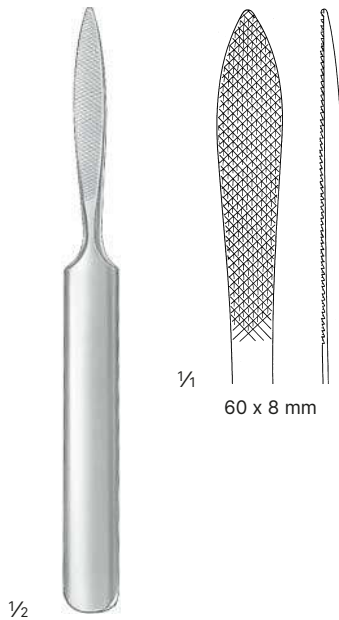

Joseph
KB 507-16
16 cm / 6 2/8"

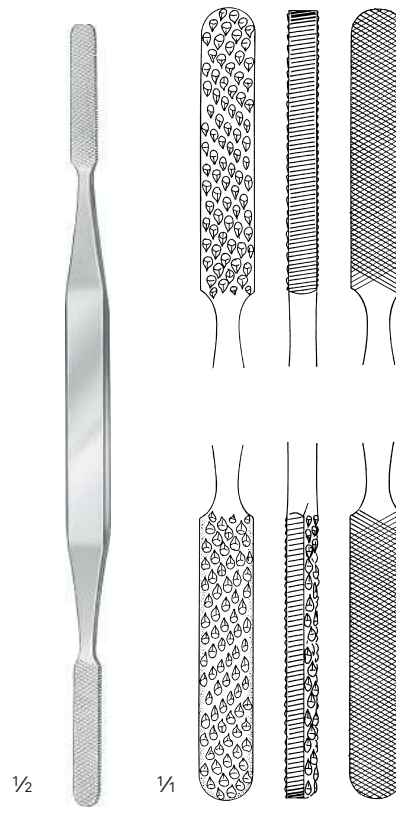

7 mm
Fomon
KB 505-21
20,5 cm / 8 1/8"



Maltz
17 cm / 6 6/8"

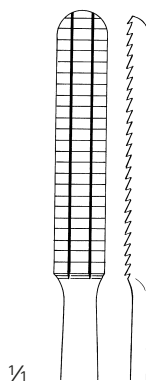

KB 510-18
drawing cut
34 x 7 mm

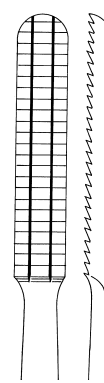

KB 511-18
pushing cut
34 x 7 mm

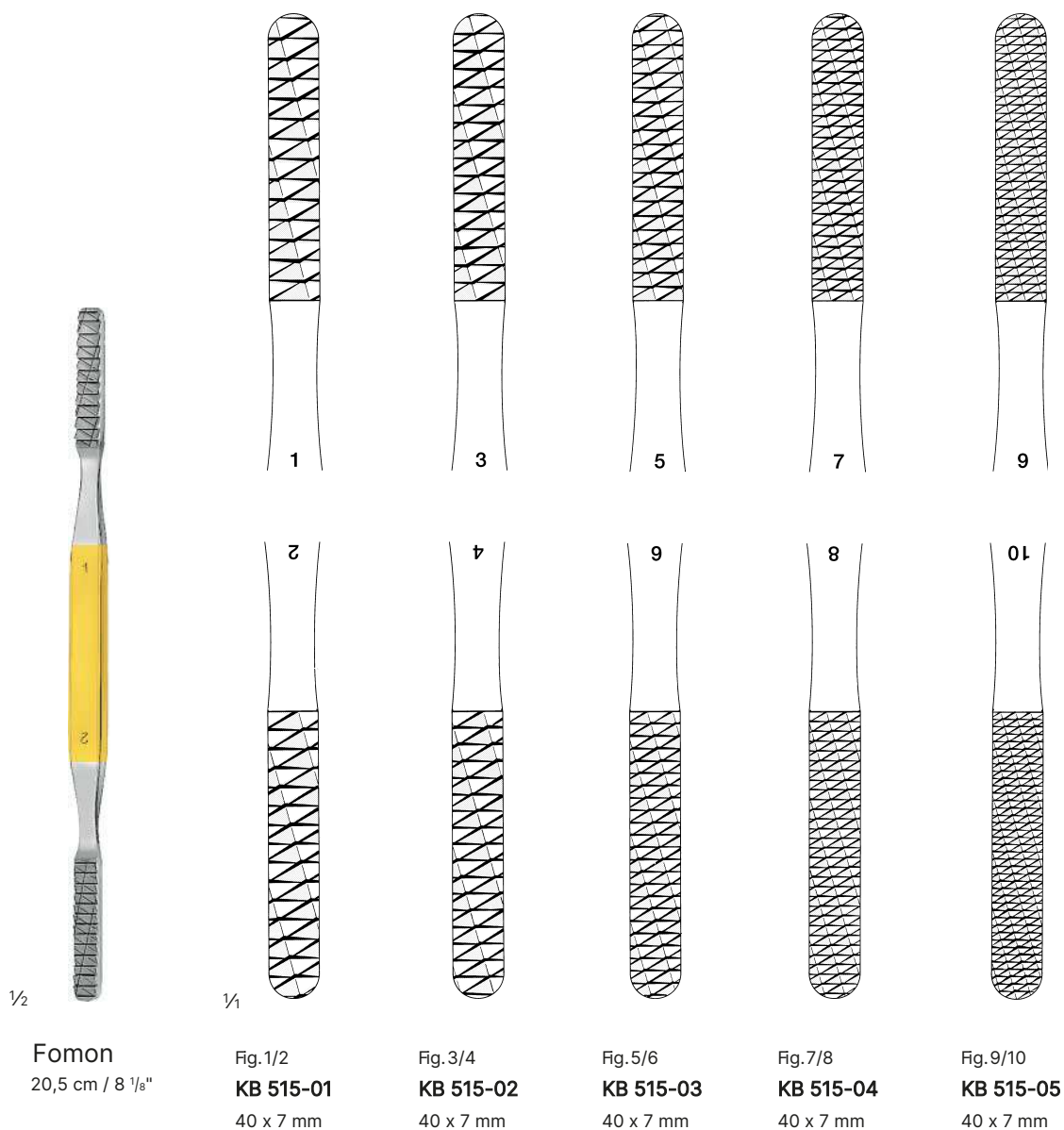

1/2

Fomon
20,5 cm / 8 1/8"

1/1

Fig. 1/2
KB 515-01
40 x 7 mm

Fig. 3/4
KB 515-02
40 x 7 mm

Fig. 5/6
KB 515-03
40 x 7 mm

Fig. 7/8
KB 515-04
40 x 7 mm

Fig. 9/10
KB 515-05
40 x 7 mm



1/2

Miller-Colburn

18 cm / 7 1/8"
downwards cutting

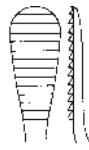

6,6 mm

Fig.1
KB 516-01

4,5 mm

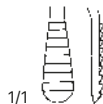

1/1

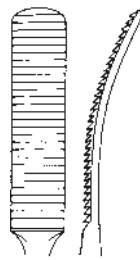

6,8 mm

Fig.2
KB 516-02

6,2 mm

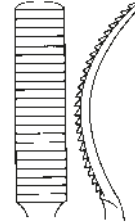
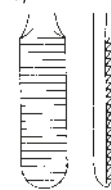

7,0 mm

Fig.3
KB 516-03

4,6 mm

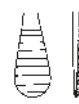

1/2

Aufricht

21 cm / 8 2/8"

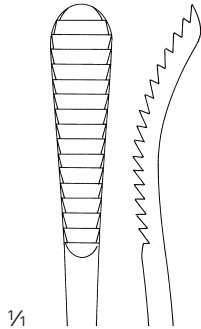

1/1

32 x 9 mm
KB 519-08
pushing cut

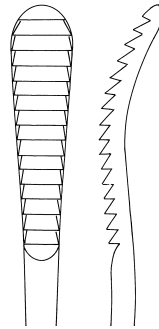

32 x 9 mm
KB 520-08
drawing cut

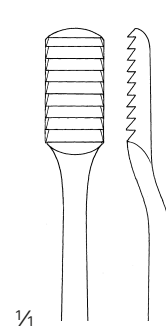

1/1

15 x 8 mm
KB 517-08
drawing cut
delicate serration

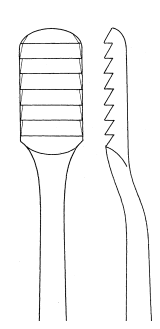

15 x 8 mm
KB 518-08
drawing cut
coarse serration



1/2

Lewis

19 cm / 7 4/8"

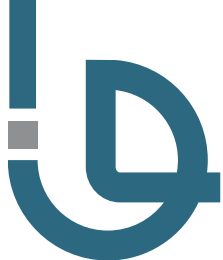

Rhinology, Rhinoplasty, Sinus and Hypophysectomy Instruments

Nasal Hooks, Nasal Retractors

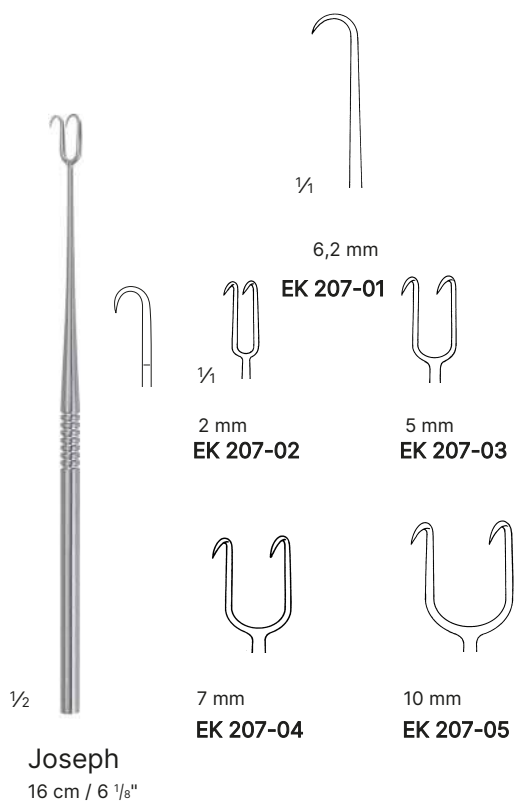
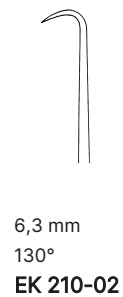

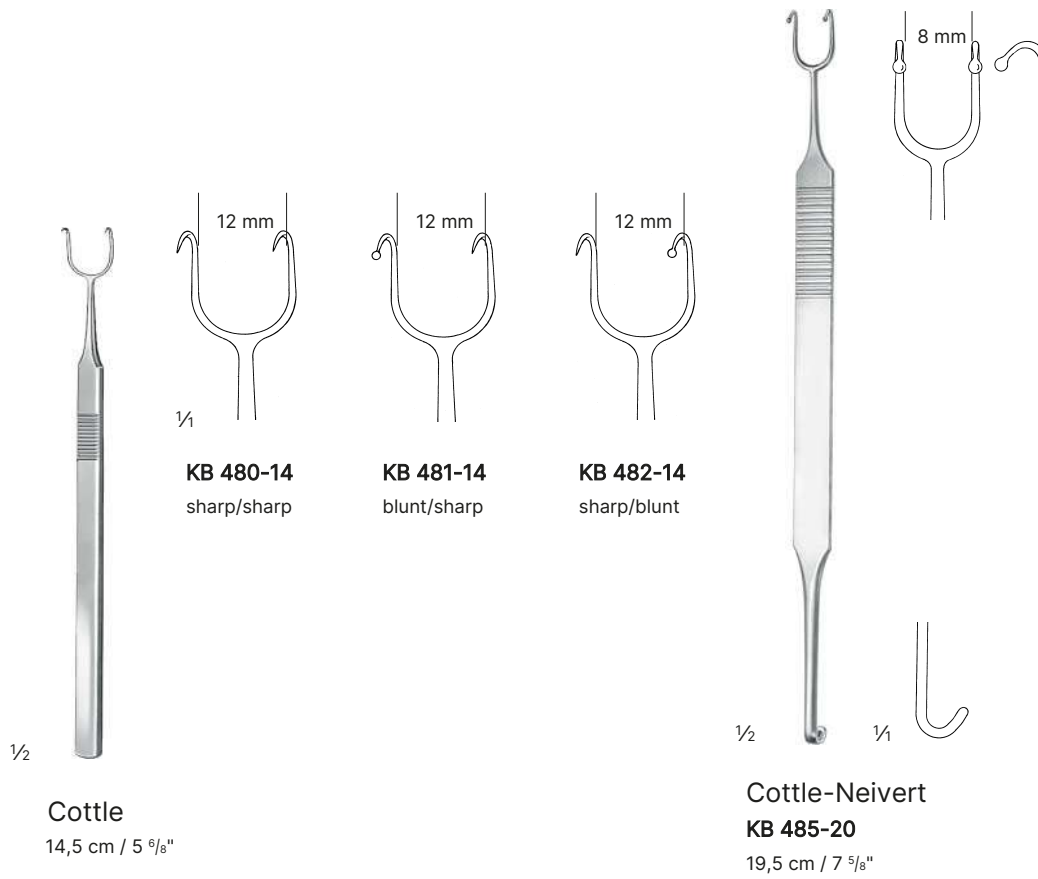



12,5 mm



1/2

Cottle
EK 216-01
14 cm / 5 4/8"
Saddle Hook

13 mm



1/2

Cottle
KB 489-15
16 cm / 6 2/8"



1/2

Aufricht
KB 487-12
12 cm / 4 6/8"
blunt

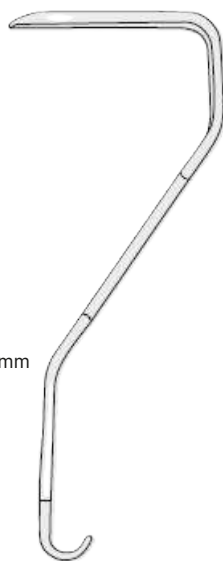

blades
60 x 6,5 mm



1/2

Aufricht
KB 488-16
19 cm / 7 4/8"

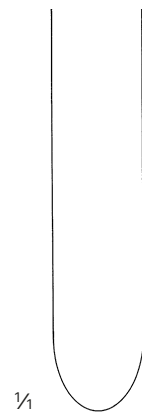

1/4

45 x 11 mm

Tonsillectomy, Adenotomy, Laryngology and Tracheotomy Instruments

Mouth Gags
Tongue Depressors
Organ and Tissue Forceps
Tissue Grasping Clamps
Tonsil Dissectors
Tonsil Scissors
Tonsil Snare
Snare Saw
Adenoid Curettes
Operation Laryngoscope
Micro Laryngeal Instruments
Tracheal Retractors
Tracheal Dilators



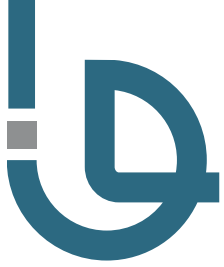

Bruenings

KB 528-02

19 cm / 7 ⁴/₈"



Weder

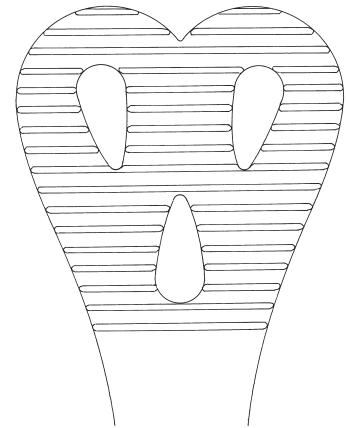

KB 529-15

15 cm / 5 ⁷/₈"

43 mm

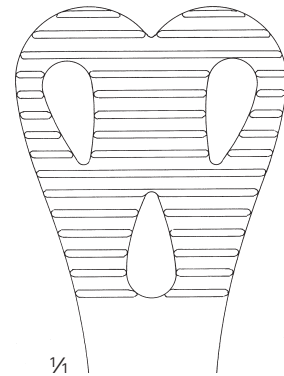

KB 528-15

14 cm / 5 ⁴/₈"

36 mm

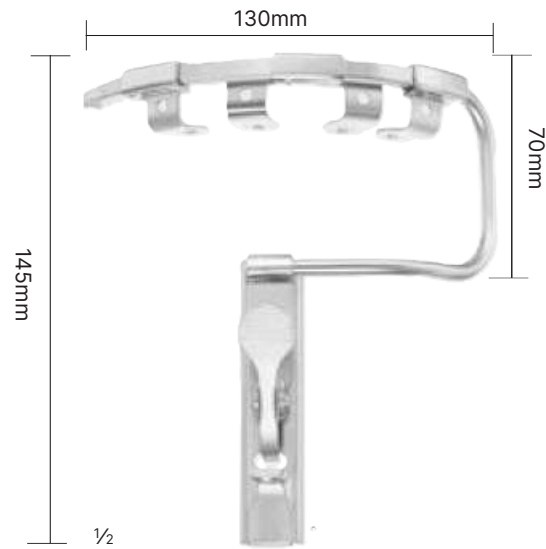

Davis-Meyer
KB 531-00

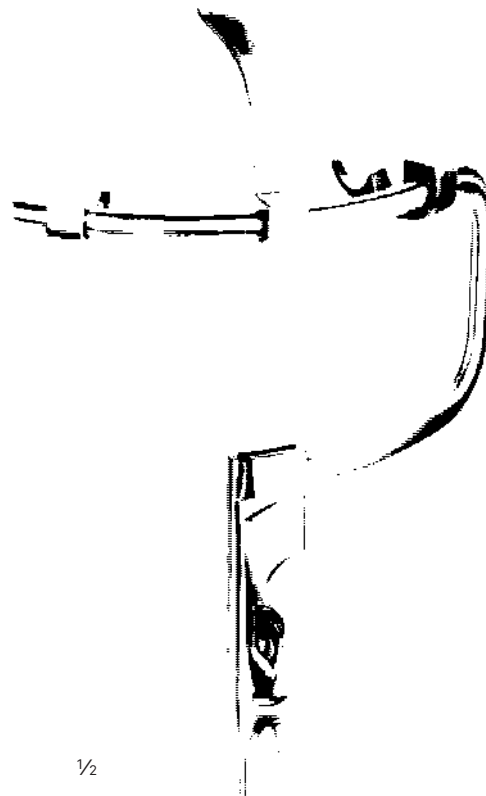

Kilner-Doughty
KB 532-00

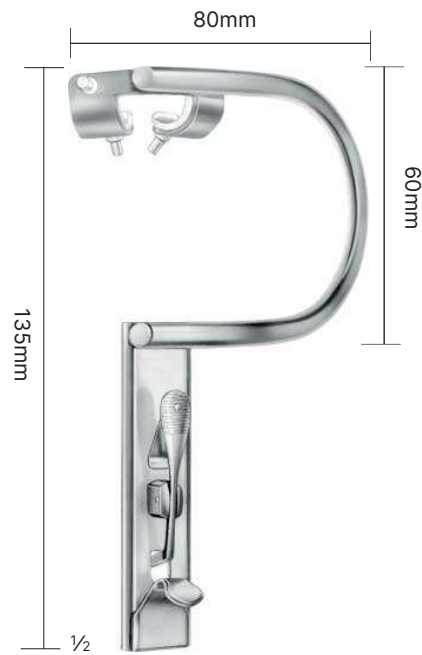
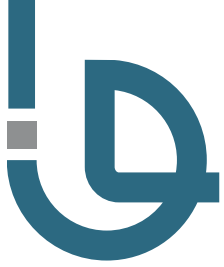

Davis-Boyle

KB 533-00

for children

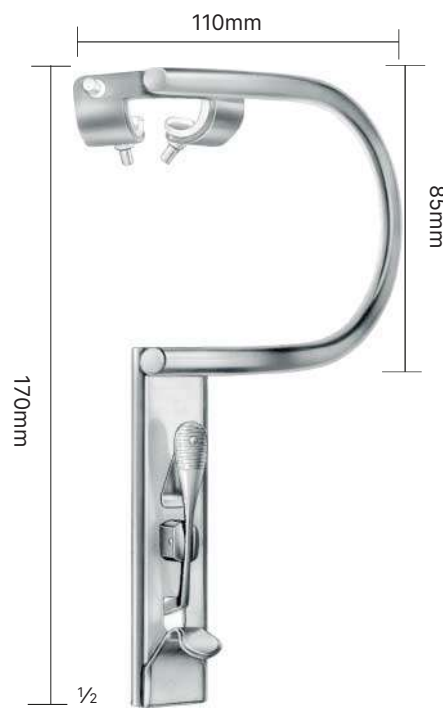

Davis Boyle

KB 533-01

for adults

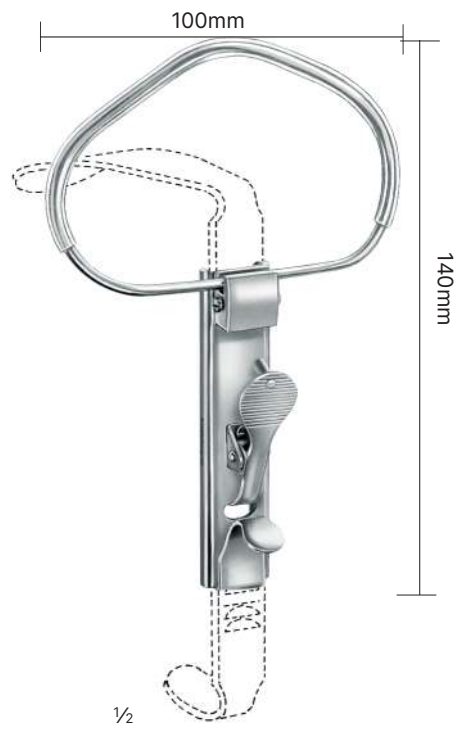

1/2

Mclvor
KB 533-02

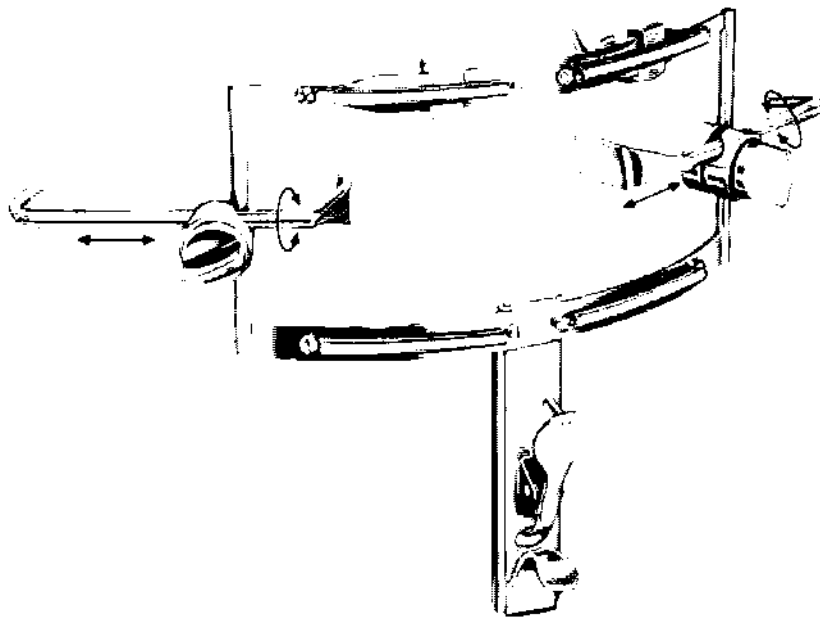

Dingmann
KB 534-00



Tonsillectomy, Adenotomy, Laryngology and Tracheotomy Instruments

Tongue Depressors



1/2

KB 530-29

67 x 29 mm

KB 530-33

75 x 33 mm

KB 530-38

85 x 38 mm



KB 530-40

92 x 40 mm

KB 530-46

100 x 46 mm



Russel Davis



KB 531-18

57 x 18 mm

KB 531-22

67 x 22 mm

KB 531-25

75 x 25 mm



KB 533-00

KB 533-01

KB 533-02

KB 531-00

KB 534-00

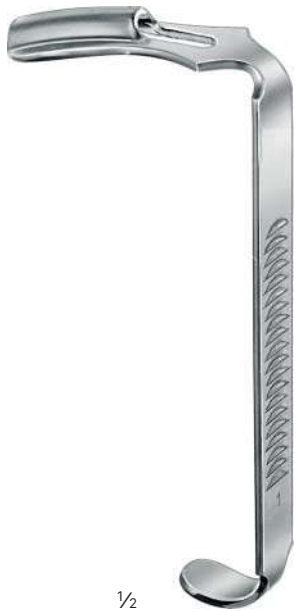

1/2

Fig. 1
KB 534-25
65 x 25 mm



Fig. 2
KB 534-29
70 x 29 mm

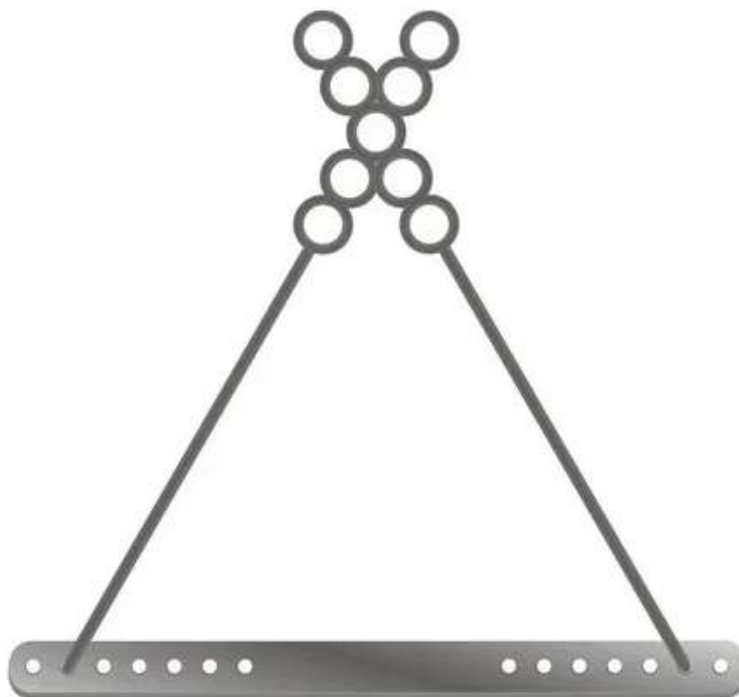

Fig. 3
KB 534-32
80 x 32 mm

Dingmann



- KB 533-00
- KB 533-01
- KB 533-02
- KB 531-00
- KB 534-00



Magauran
KB 530-00

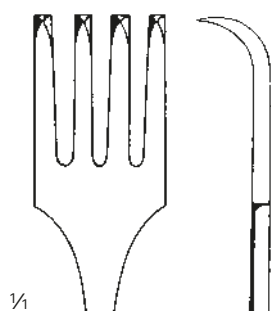

TN 102-25
26,5 cm / 10 3/8"



4x4

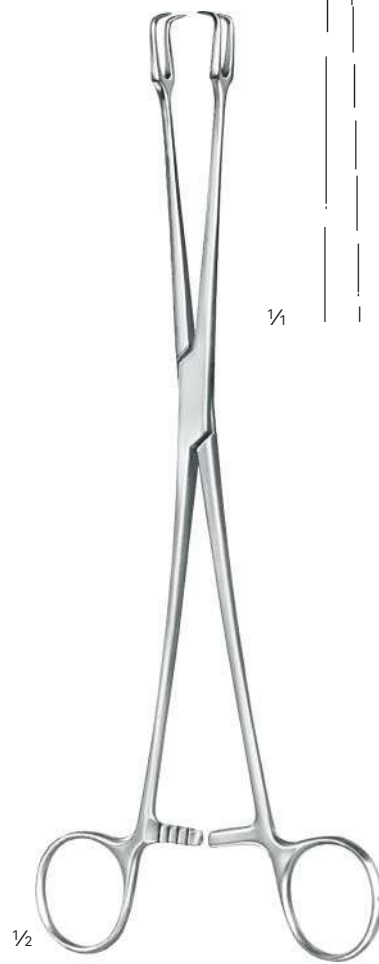
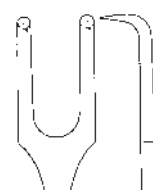

Schröder
TN 208-20
25 cm / 9 7/8"



2x2

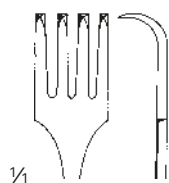

Braun
TN 207-15
16 cm / 6 2/8"



4x4

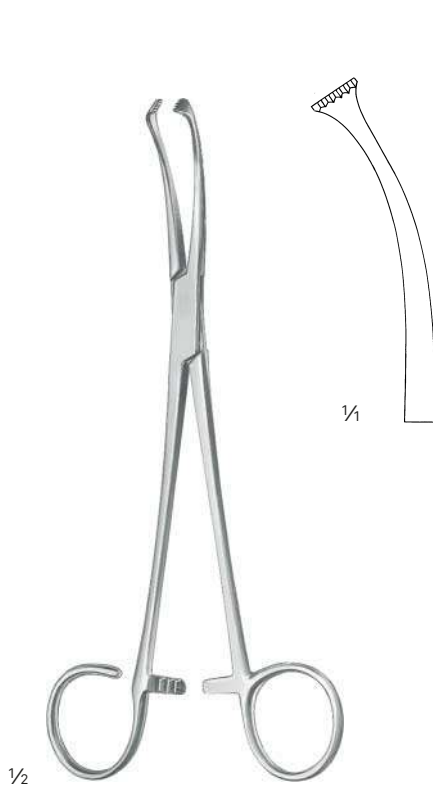

White
KB 544-01
18 cm / 7 1/8"

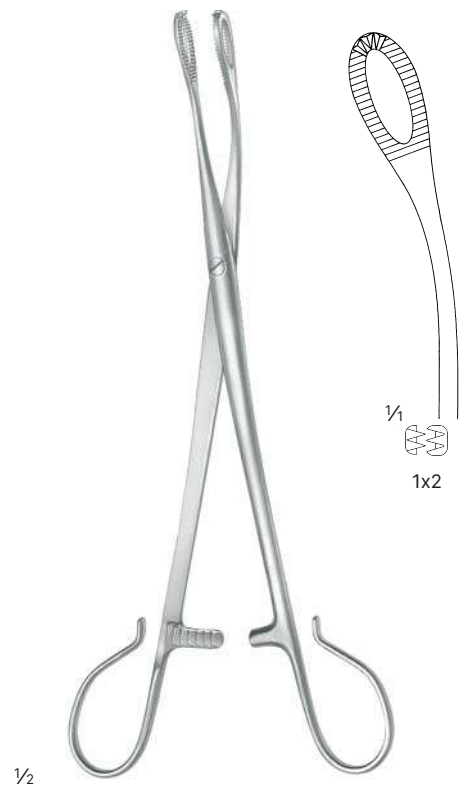

Blohmke
KB 542-20
20 cm / 7 7/8"



Schnidt

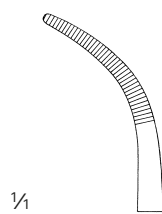

HM 431-01
18,5 cm / 7 2/8"



HM 431-02
19 cm / 7 4/8"



Hurd
KB 552-21
22,5 cm / 8 ⁷/₈"
Tonsil Dissector / Retractor

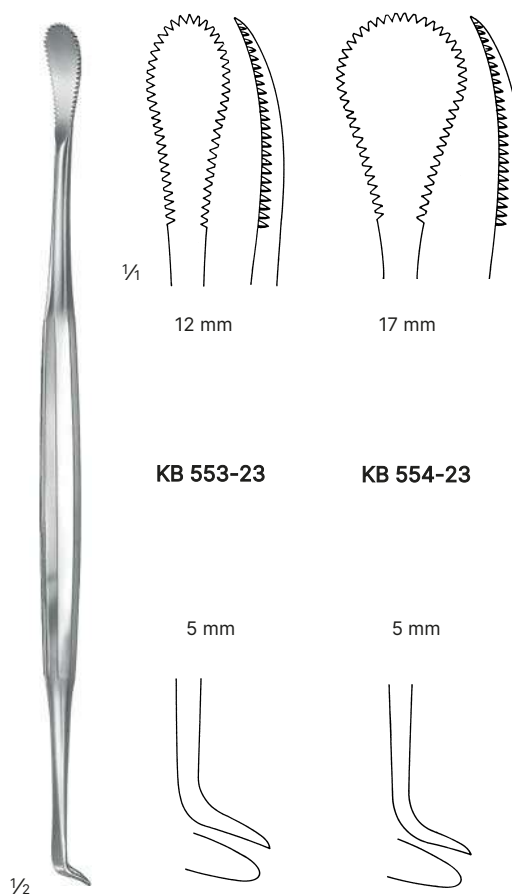

Henke
24,5 cm / 9 ⁵/₈"



Boettcher
KB 601-18
 18 cm / 7 ²/₈"

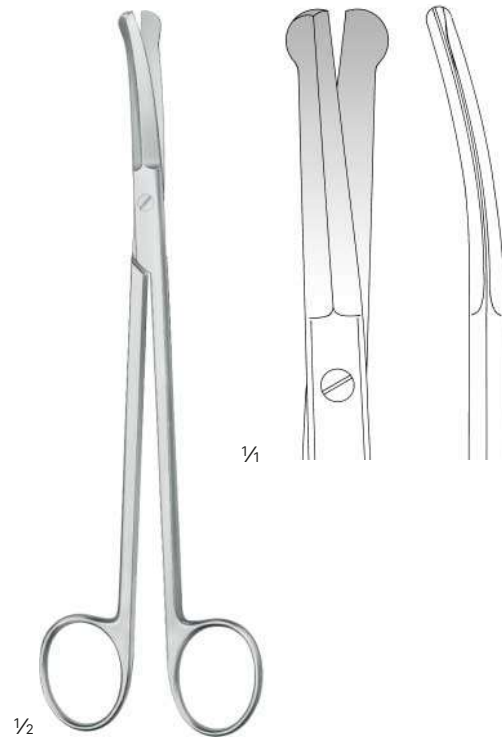

Good
KB 602-19
 19,5 cm / 7 ⁵/₈"



Tonsillectomy, Adenotomy, Laryngology and Tracheotomy Instruments

Tonsil Snares, Snare Saws

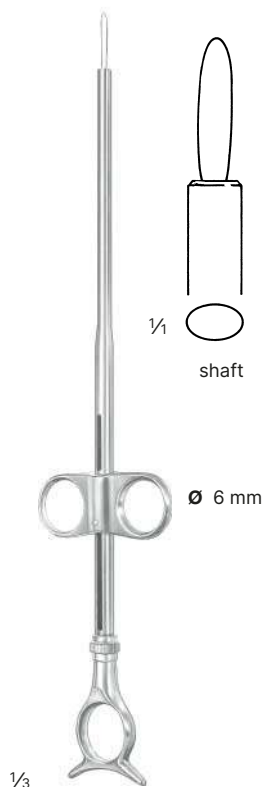

Eves

KB 610-25

28,5 cm / 11 2/8"
without ratchet



Eves

KB 611-25

28,5 cm / 11 2/8"
with ratchet



Brunings

KB 612-27

29 cm / 11 3/8"
with double ratchet



Ø 0,3 mm

KB 613-03

Snare Wire, package of 12 pieces

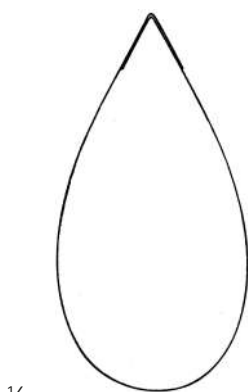

1/4

Wire Loop, package of 100 pieces

KB 614-03

Ø 50 x 0,3 mm

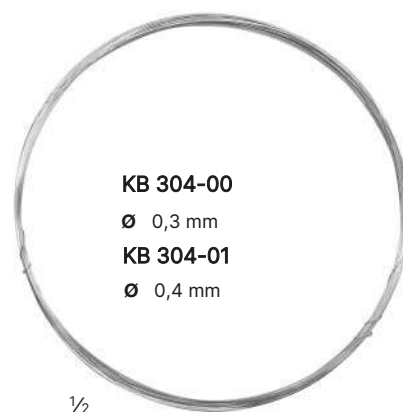

1/2

KB 304-00

Ø 0,3 mm

KB 304-01

Ø 0,4 mm

Snare Wire

coil of 10 m



1/2

Beckmann

22 cm / 8 5/8"

1/4

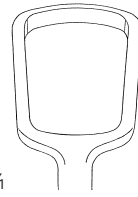

| | | |
|------------------|-------|-------|
| KB 620-01 | Fig.1 | 13 mm |
| KB 620-02 | Fig.2 | 15 mm |
| KB 620-03 | Fig.3 | 17 mm |
| KB 620-04 | Fig.4 | 19 mm |
| KB 620-05 | Fig.5 | 21 mm |
| KB 620-06 | Fig.6 | 23 mm |

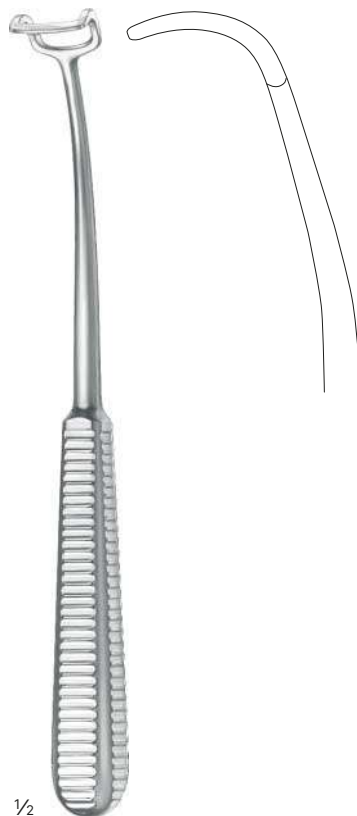

1/2

Beckmann

21,5 cm / 8 4/8"

1/4

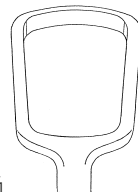

| | | |
|------------------|-------|-------|
| KB 621-01 | Fig.1 | 13 mm |
| KB 621-02 | Fig.2 | 15 mm |
| KB 621-03 | Fig.3 | 17 mm |
| KB 621-04 | Fig.4 | 19 mm |
| KB 621-05 | Fig.5 | 21 mm |
| KB 621-06 | Fig.6 | 23 mm |



Tonsillectomy, Adenotomy, Laryngology and Tracheotomy Instruments

Operation Laryngoscope



KB 630-00

Chest support with support bar and joint for adults

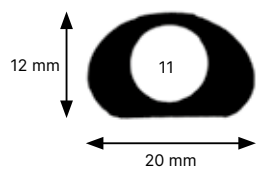

KB 631-04

Length
135mm

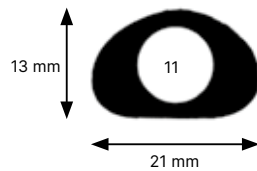

KB 631-03

Length
152mm

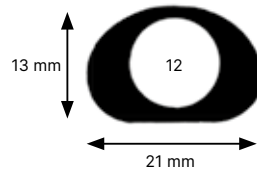

KB 631-02

Length
192mm

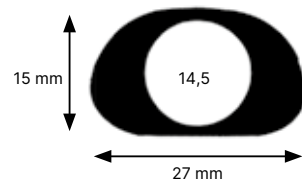

KB 631-01

Length
172mm

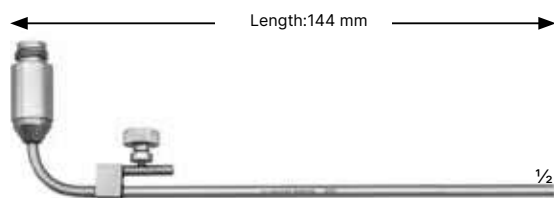

KB 631-10

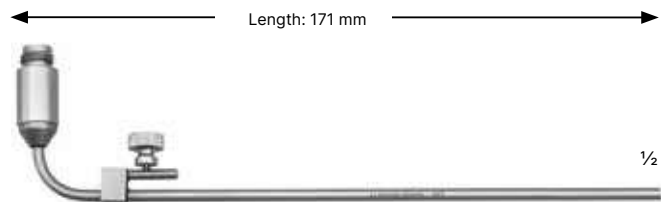

KB 631-11

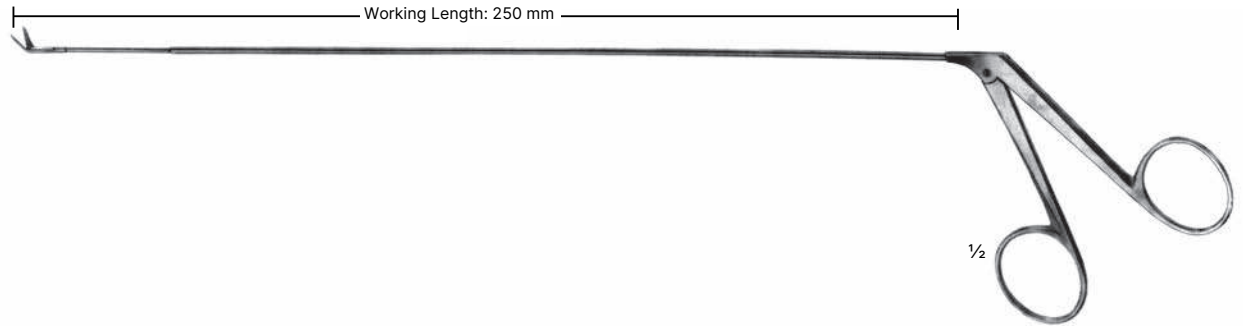

KB 640-00
Grasping Forceps



KB 640-01
Grasping Forceps curved left



KB 640-02
Grasping Forceps curved right



KB 640-03
Cup Forceps



KB 640-04
Cup Forceps curved left



KB 640-05
Cup Forceps curved right



KB 640-06
Cup Forceps angled upward



KB 640-07
Scissors



KB 640-08
Scissors curved left



KB 640-09
Scissors curved right



KB 640-10
Scissors angled upward



KB 640-11
Cartilage Forceps
1x2 toothed

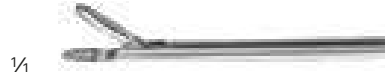

KB 640-12
Needle Holder

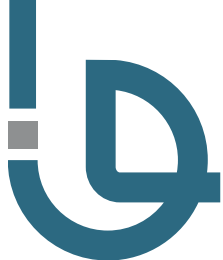

Tonsillectomy, Adenotomy, Laryngology and Tracheotomy Instruments

Micro Laryngeal Instruments

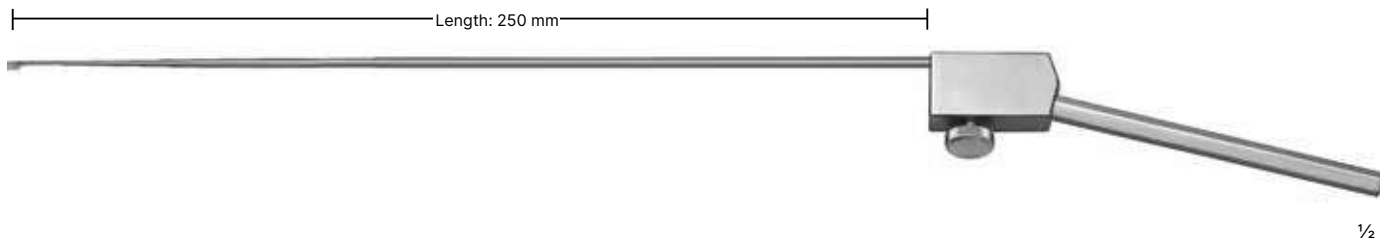

KB 380-01 Sickle knife



KB 380-02 Separator oval blade, horizontal



KB 380-03 Separator oval blade, vertical



KB 380-04 Round cutting knife, angled
45° - Ø 3,5 mm



KB 380-05 Hook angled
90°



KB 380-06 Hook backwars curved
30°



KB 380-07 Suture guide, fork-shaped



KB 380-00 Handle

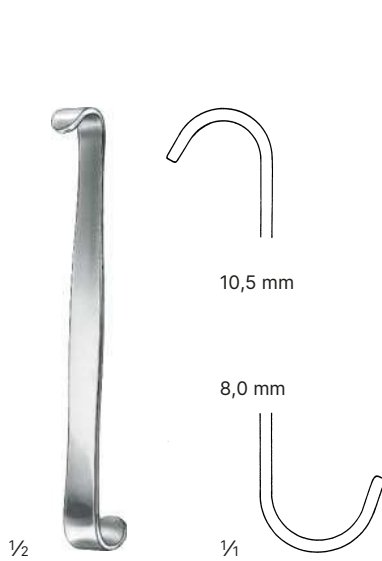

Luer
EK 403-01
11 cm / 4 ³/₈"

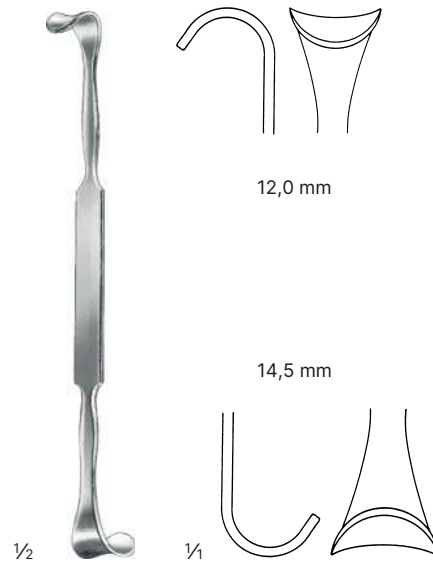

Rose
EK 403-02
15,5 cm / 6 ¹/₈"

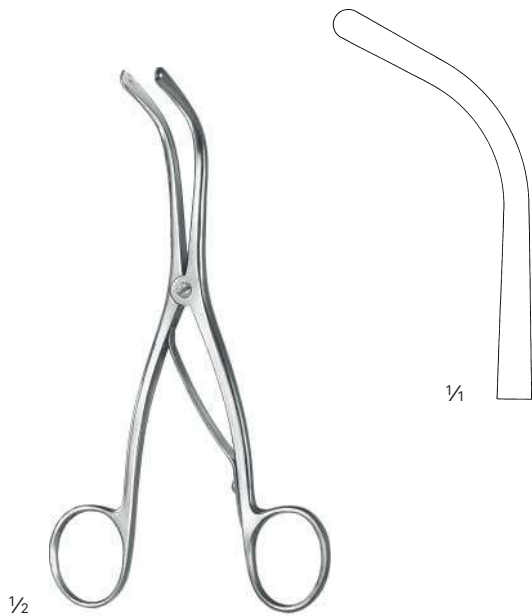

Trousseau
KB 700-12
14,5 cm / 5 ⁶/₈"



Laborde
KB 701-13
14 cm / 5 ⁴/₈"

Examination-Diagnostic, Preparation, Anesthesia and Miscellaneous Instruments

Catheter Introducing Forceps

Tongue Forceps

Tubing Clamps

Dressing Forceps

Nail Nipper

Finger Ring Saw

Instrument Holders

Stainless Steel Bowls

Kidney Tray

Trays

Instrument Boxes





for babies



1/4

KB 220-15

15,5 cm / 6 1/8"

for children



KB 220-20

17,5 cm / 6 7/8"

for adults

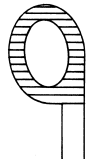

KB 220-25

20 cm / 7 7/8"



1/2

Magill

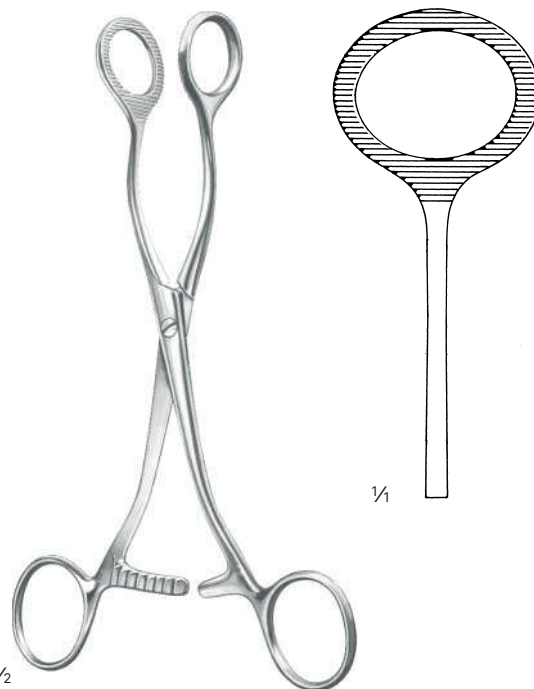

1/4

1/2

Collin

HM 425-16

17 cm / 6 5/8"

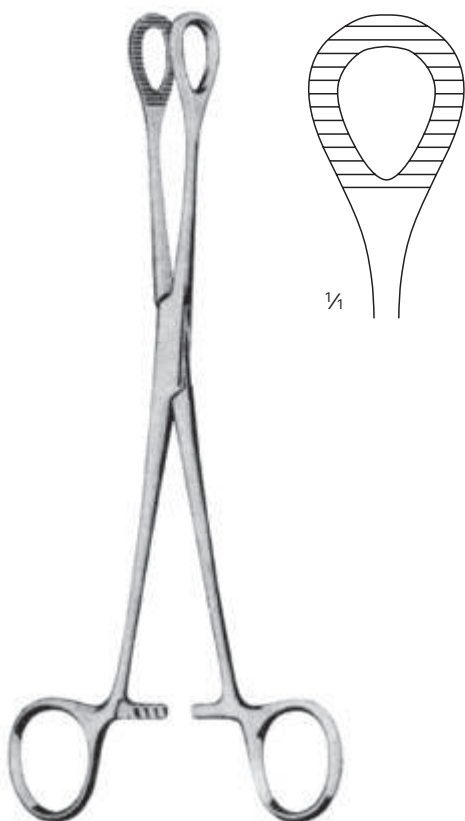

1/4

1/2

Heywood-Smith

CM 219-21

21 cm / 8 1/4"

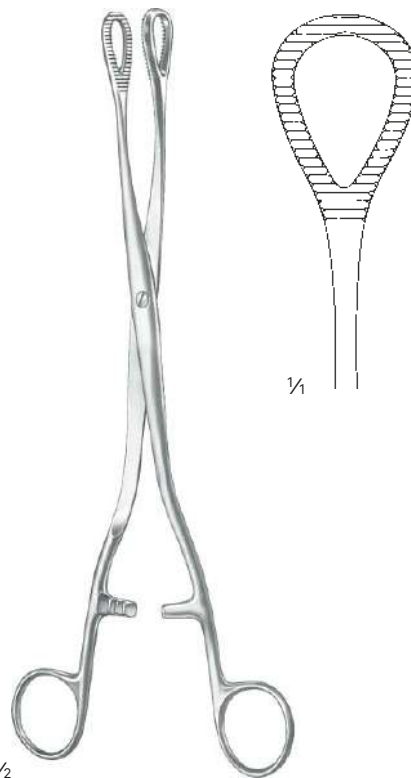

1/4

1/2

Heywood-Smith

CM 220-21

20 cm / 7 7/8"

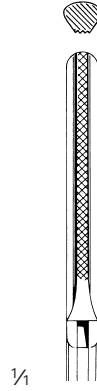

HM 815-15
15,5 cm / 6 1/8"

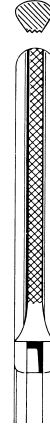

HM 815-18
19 cm / 7 4/8"

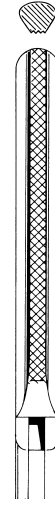

HM 815-20
20,5 cm / 8 1/8"

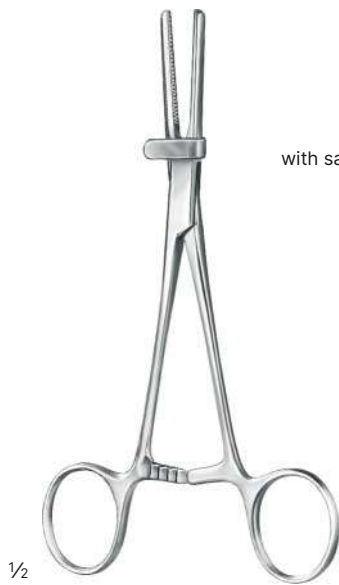

with safety guard

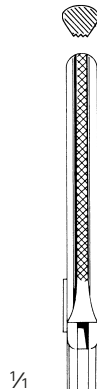

HM 816-15
15,5 cm / 6 1/8"

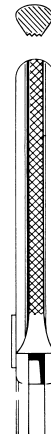

HM 816-18
19 cm / 7 4/8"

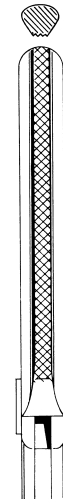

HM 816-20
20,5 cm / 8 1/8"

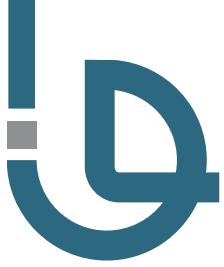

1/2

Gross-Maier

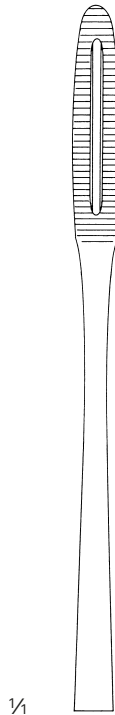

1/4

CM 205-20

20,5 cm / 8 1/8"

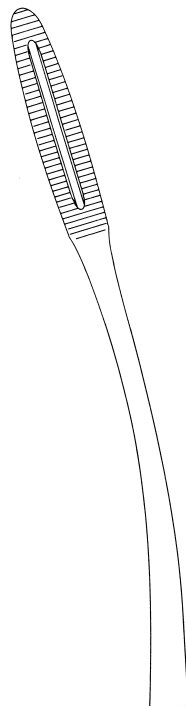

CM 206-20

20,5 cm / 8 1/8"



1/2

Ulrich

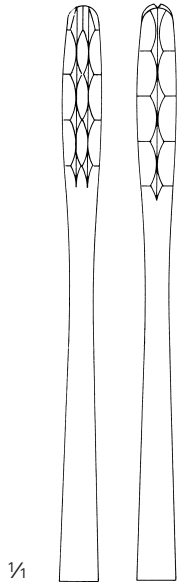

1/4

CM 201-22

22,5 cm / 8 7/8"



1/4

CM 202-22

22,5 cm / 8 7/8"



1/2

Mayo
HM 160-14
14 cm / 5 4/8"



1/2

MA 707-11
10,5 cm / 4 1/8"
straight cutting edges



1/2

OF 240-15
15 cm / 5 6/8"



OF 241-00
Spare Saw Blade

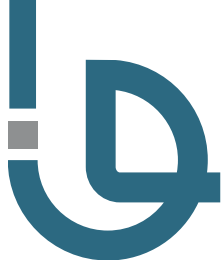

Examination-Diagnostic, Preparation, Anesthesia and Miscellaneous Instruments

Stainless Steel Bowls, Kidney Tray

TS 101-0103

80mmx100mmX350mm



TS 101-0104

125mmx40mm 250 ml

TS 101-0105

130mmx45mm 360 ml

TS 101-0106

145mmx50mm 480 ml

TS 101-0107

165mmx50mm 750 ml

TS 101-0108

200mmx50mm 1000 ml



TS 101-0110

255mmx125mmx35mm

TS 101-0113

145mmx304mmx40mm



TS 101-0109

300mmx160mm 8000 ml





TS 101-0115 430mmx270mmx40mm

TS 101-0118 380mmx280mmx80mm



TS 101-0120 280mmx180mmx35mm

TS 101-0125 320mmx230mmx40mm



TS 200-0120 350mmx180mmx70mm

TS 200-0125 400mmx200mmx80mm

Numerical Index





| Catalog Code | Page | Catalog Code | Page | Catalog Code | Page | Catalog Code | Page |
|--------------|----------|--------------|----------|--------------|--------------|--------------|----------|
| AS 100-04 |336 | AS 201-05 |337 | BS 501-19 |348 | DP 100-06 |347 |
| AS 100-06 |336 | AS 250-12 |337 | BS 502-16 |348 | DP 104-16 |350 |
| AS 100-08 |336 | AS 270-01 |339 | BS 503-17 |348 | DP 105-16 |350 |
| AS 100-10 |336 | AS 270-02 |339 | BS 506-01 |378 | DP 106-16 |350 |
| AS 100-12 |336 | AS 270-03 |339 | BS 506-02 |378 | DP 108-01 |350 |
| AS 100-15 |336 | AS 300-00 |340 | BS 507-01 |378 | DP 108-02 |350 |
| AS 101-04 |336 | AS 300-01 |340 | BS 508-01 |378 | DP 110-14 |351 |
| AS 101-06 |336 | AS 300-02 |340 | BS 509-01 |378 | DP 111-14 |351 |
| AS 101-08 |336 | AS 300-03 |340 | BS 510-01 |378 | DP 112-14 |351 |
| AS 101-10 |336 | AS 300-04 |340 | CM 201-22 |64,414 | DP 113-01 |350 |
| AS 101-12 |336 | AS 310-00 |339 | CM 201-25 |64 | DP 114-15 |351 |
| AS 101-15 |336 | AS 310-01 |339 | CM 202-22 |64,414 | DP 115-15 |351 |
| AS 102-04 |336 | AS 310-02 |339 | CM 202-25 |64 | DP 116-15 |351 |
| AS 102-06 |336 | AS 310-03 |339 | CM 205-20 |65,414 | DP 117-15 |351 |
| AS 102-08 |336 | AS 310-04 |339 | CM 205-22 |65 | DP 118-15 |351 |
| AS 102-10 |336 | AS 310-05 |339 | CM 205-25 |65 | DP 130-01 |349 |
| AS 102-12 |336 | AS 311-05 |339 | CM 205-27 |65 | DP 130-02 |349 |
| AS 102-15 |336 | AS 315-20 |341 | CM 206-20 |65,414 | DP 130-03 |349 |
| AS 103-04 |336 | AS 352-27 |341 | CM 206-22 |65 | DP 130-04 |349 |
| AS 103-06 |336 | AS 355-27 |342 | CM 206-25 |65 | DP 130-05 |349 |
| AS 103-08 |336 | AS 356-28 |342 | CM 206-27 |65 | DP 130-06 |349 |
| AS 103-10 |336 | AS 360-01 |343 | CM 211-26 |254 | DP 130-07 |349 |
| AS 103-12 |336 | AS 360-02 |343 | CM 218-32 |257 | DP 140-02 |349 |
| AS 103-15 |336 | BS 200-03 |2 | CM 219-21 |227,412 | DP 140-03 |349 |
| AS 110-45 |338 | BS 201-03 |2 | CM 220-21 |227,412 | DP 140-04 |349 |
| AS 110-55 |338 | BS 201-04 |2 | CM 223-18 |66 | DP 140-05 |349 |
| AS 111-30 |339 | BS 202-13 |2 | CM 223-20 |66 | DP 141-01 |349 |
| AS 111-35 |339 | BS 203-14 |2 | CM 223-25 |66 | DP 141-02 |349 |
| AS 115-15 |338 | BS 210-07 |3 | CM 224-18 |66 | DP 141-03 |349 |
| AS 115-25 |338 | BS 211-07 |3 | CM 224-20 |66 | DP 141-04 |349 |
| AS 115-30 |338 | BS 212-16 |3 | CM 224-25 |66 | DP 141-05 |349 |
| AS 120-15 |337 | BS 213-16 |3 | CM 225-25 |66 | DP 141-06 |349 |
| AS 120-20 |337 | BS 220-21 |2 | CM 226-25 |66 | DP 141-07 |349 |
| AS 120-25 |337 | BS 221-21 |2 | CM 229-25 |66 | EK 130-15 |390 |
| AS 120-30 |337 | BS 231-21 |4 | CM 250-25 |227,257 | EK 140-01 |134 |
| AS 120-35 |337 | BS 232-21 |4 | CM 250-27 |227,257 | EK 170-01 |135 |
| AS 120-40 |337 | BS 241-21 |4 | CM 252-01 |268 | EK 170-02 |135 |
| AS 120-50 |337 | BS 242-01 |5 | CM 252-02 |268 | EK 173-01 |137 |
| AS 200-15 |337 | BS 242-02 |5 | CM 262-01 |268 | EK 173-02 |137 |
| AS 200-20 |337 | BS 242-03 |5 | CM 262-02 |268 | EK 173-03 |137 |
| AS 200-25 |337 | BS 242-04 |5 | DP 100-01 |347 | EK 174-01 |137 |
| AS 200-30 |337 | BS 243-21 |5 | DP 100-02 |347 | EK 174-02 |137 |
| AS 201-02 |337 | BS 244-25 |5 | DP 100-03 |347 | EK 174-03 |137 |
| AS 201-03 |337 | BS 500-16 |348 | DP 100-04 |347 | EK 175-01 |137 |
| AS 201-04 |337 | BS 501-18 |348 | DP 100-05 |347 | EK 175-02 |137 |

| Catalog Code | Page | Catalog Code | Page | Catalog Code | Page | Catalog Code | Page |
|--------------|----------|--------------|----------|--------------|-------------|--------------|----------|
| EK 175-03 |137 | EK 217-14 |139 | EK 233-04 |145 | EK 352-02 |150 |
| EK 176-01 |137 | EK 217-16 |139 | EK 233-06 |145 | EK 353-01 |151 |
| EK 176-02 |137 | EK 217-18 |139 | EK 234-01 |145 | EK 353-02 |151 |
| EK 176-03 |137 | EK 218-08 |140 | EK 234-02 |145 | EK 353-03 |151 |
| EK 177-01 |136 | EK 218-10 |140 | EK 234-03 |145 | EK 353-04 |151 |
| EK 177-02 |136 | EK 218-12 |140 | EK 234-04 |145 | EK 353-05 |151 |
| EK 177-03 |136 | EK 218-14 |140 | EK 234-06 |145 | EK 354-01 |177 |
| EK 177-04 |136 | EK 218-16 |140 | EK 235-21 |146 | EK 354-02 |177 |
| EK 178-01 |136 | EK 218-18 |140 | EK 236-21 |146 | EK 354-03 |177 |
| EK 178-02 |136 | EK 219-08 |140 | EK 237-20 |146 | EK 354-04 |177 |
| EK 178-03 |136 | EK 219-10 |140 | EK 239-01 |147 | EK 355-01 |152 |
| EK 203-01 |138 | EK 219-12 |140 | EK 239-02 |147 | EK 355-02 |152 |
| EK 203-02 |138 | EK 219-14 |140 | EK 239-03 |147 | EK 355-03 |152 |
| EK 203-03 |138 | EK 219-16 |140 | EK 239-04 |147 | EK 355-04 |152 |
| EK 203-04 |138 | EK 219-18 |140 | EK 239-05 |147 | EK 355-05 |152 |
| EK 204-01 |138 | EK 222-15 |141 | EK 239-06 |147 | EK 355-06 |152 |
| EK 204-02 |138 | EK 223-15 |141 | EK 239-07 |147 | EK 355-07 |152 |
| EK 204-03 |138 | EK 224-16 |141 | EK 239-08 |147 | EK 355-08 |152 |
| EK 204-04 |138 | EK 225-16 |141 | EK 240-08 |148 | EK 355-09 |152 |
| EK 207-01 |390 | EK 226-14 |141 | EK 241-08 |148 | EK 356-18 |152 |
| EK 207-02 |390 | EK 228-07 |298 | EK 260-01 |157 | EK 356-20 |152 |
| EK 207-03 |390 | EK 228-10 |298 | EK 260-02 |157 | EK 356-25 |152 |
| EK 207-04 |390 | EK 229-01 |144 | EK 260-03 |157 | EK 357-01 |154 |
| EK 207-05 |390 | EK 229-02 |144 | EK 260-04 |157 | EK 357-02 |154 |
| EK 208-01 |134 | EK 229-03 |144 | EK 263-01 |156 | EK 357-03 |154 |
| EK 208-02 |134 | EK 229-04 |144 | EK 263-02 |156 | EK 358-25 |155 |
| EK 210-01 |390 | EK 229-06 |144 | EK 265-19 |154 | EK 360-22 |155 |
| EK 210-02 |390 | EK 230-01 |144 | EK 265-35 |173,244 | EK 360-27 |155 |
| EK 211-13 |134 | EK 230-02 |144 | EK 265-45 |173,244 | EK 371-01 |161 |
| EK 212-01 |138 | EK 230-03 |144 | EK 265-60 |173,244 | EK 371-02 |161 |
| EK 212-03 |138 | EK 230-04 |144 | EK 266-35 |173,244 | EK 371-03 |161 |
| EK 212-05 |138 | EK 230-06 |144 | EK 266-45 |173,244 | EK 371-04 |161 |
| EK 213-02 |138 | EK 231-01 |144 | EK 266-60 |173,244 | EK 371-54 |161 |
| EK 213-04 |138 | EK 231-02 |144 | EK 267-35 |173,244 | EK 372-01 |160 |
| EK 213-06 |138 | EK 231-03 |144 | EK 267-45 |173,244 | EK 372-02 |160 |
| EK 214-10 |139 | EK 231-04 |144 | EK 267-60 |173,244 | EK 373-01 |158 |
| EK 214-20 |139 | EK 231-06 |144 | EK 268-45 |173,244 | EK 373-02 |158 |
| EK 215-10 |139 | EK 232-01 |145 | EK 268-60 |173,244 | EK 373-03 |158 |
| EK 215-17 |139 | EK 232-02 |145 | EK 350-30 |148 | EK 373-04 |158 |
| EK 215-20 |139 | EK 232-03 |145 | EK 350-60 |148 | EK 373-05 |158 |
| EK 215-22 |139 | EK 232-04 |145 | EK 351-40 |149 | EK 373-06 |158 |
| EK 216-01 |392 | EK 232-06 |145 | EK 351-50 |149 | EK 374-40 |174 |
| EK 217-08 |139 | EK 233-01 |145 | EK 351-60 |149 | EK 374-50 |174 |
| EK 217-10 |139 | EK 233-02 |145 | EK 351-70 |149 | EK 374-60 |174 |
| EK 217-12 |139 | EK 233-03 |145 | EK 352-01 |150 | EK 374-75 |174 |



| Catalog Code | Page | Catalog Code | Page | Catalog Code | Page | Catalog Code | Page |
|--------------|----------|--------------|----------|--------------|--------------|--------------|--------------|
| EK 374-85 |174 | EK 398-00 |142 | EK 457-01 |186 | EK 491-25 |205 |
| EK 375-25 |156 | EK 399-00 |143 | EK 457-02 |186 | EK 492-01 |207 |
| EK 375-42 |156 | EK 400-00 |143 | EK 457-27 |185 | EK 492-02 |207 |
| EK 375-50 |156 | EK 401-00 |143 | EK 458-13 |187 | EK 493-01 |207 |
| EK 375-60 |156 | EK 403-01 |409 | EK 458-16 |187 | EK 493-02 |206,207 |
| EK 376-30 |159 | EK 403-02 |409 | EK 458-20 |187 | EK 493-03 |207 |
| EK 376-35 |159 | EK 420-05 |178 | EK 458-25 |187 | EK 495-01 |210 |
| EK 376-55 |159 | EK 420-07 |178 | EK 459-13 |187 | EK 495-02 |210 |
| EK 377-25 |175 | EK 421-05 |178 | EK 459-16 |187 | EK 495-03 |210 |
| EK 378-23 |173 | EK 421-07 |178 | EK 459-20 |187 | EK 497-00 |208 |
| EK 379-40 |162 | EK 424-07 |178 | EK 459-25 |187 | EK 498-00 |208 |
| EK 379-62 |162 | EK 424-10 |178 | EK 460-31 |188 | EK 499-01 |209 |
| EK 380-26 |169 | EK 425-07 |178 | EK 463-33 |188 | EK 499-02 |209 |
| EK 381-01 |170 | EK 425-10 |178 | EK 464-01 |189 | EK 499-03 |209 |
| EK 381-02 |170 | EK 428-01 |178 | EK 464-02 |189 | EK 499-04 |209 |
| EK 381-03 |170 | EK 428-02 |178 | EK 464-03 |189 | EK 499-05 |209 |
| EK 382-03 |171 | EK 432-14 |179 | EK 464-04 |189 | EK 499-06 |209 |
| EK 382-04 |171 | EK 433-13 |179 | EK 466-33 |190 | EK 499-07 |209 |
| EK 383-01 |166 | EK 434-13 |179 | EK 467-14 |191,250 | EK 504-00 |194 |
| EK 383-02 |166 | EK 435-10 |180 | EK 469-14 |191,250 | EK 505-00 |194 |
| EK 383-03 |166 | EK 435-13 |180 | EK 469-19 |191,250 | EK 506-00 |195 |
| EK 383-04 |166 | EK 435-16 |180 | EK 470-19 |191 | EK 507-00 |195 |
| EK 383-05 |166 | EK 435-20 |181 | EK 471-01 |192 | EK 508-00 |196 |
| EK 383-06 |166 | EK 435-25 |181 | EK 471-02 |192 | EK 509-00 |197 |
| EK 383-07 |167 | EK 435-26 |181 | EK 471-03 |192 | EK 510-00 |197 |
| EK 383-08 |167 | EK 436-10 |180 | EK 472-01 |192 | EK 511-01 |198 |
| EK 383-09 |167 | EK 436-13 |180 | EK 472-02 |192 | EK 511-02 |198 |
| EK 385-01 |168 | EK 436-16 |180 | EK 472-03 |192 | EK 511-03 |198 |
| EK 385-02 |168 | EK 436-20 |181 | EK 474-01 |193 | EK 511-04 |198 |
| EK 385-03 |168 | EK 436-25 |181 | EK 474-02 |193 | EK 511-05 |198 |
| EK 385-04 |168 | EK 436-26 |181 | EK 474-03 |193 | EK 511-06 |199 |
| EK 391-22 |164 | EK 437-00 |182 | EK 474-04 |193 | EK 511-07 |199 |
| EK 391-38 |164 | EK 437-19 |182 | EK 475-13 |193 | EK 511-08 |199 |
| EK 391-65 |164 | EK 437-25 |182 | EK 475-14 |193 | EK 511-09 |199 |
| EK 393-01 |172 | EK 437-32 |182 | EK 476-10 |193 | EK 511-10 |199 |
| EK 393-02 |172 | EK 438-00 |182 | EK 477-10 |193 | EK 511-11 |199 |
| EK 393-03 |172 | EK 440-13 |183 | EK 485-10 |200 | EK 550-12 |176 |
| EK 394-50 |165 | EK 441-21 |183 | EK 487-14 |201 | EK 550-17 |176 |
| EK 394-90 |165 | EK 444-13 |184 | EK 488-16 |202 | EK 550-20 |176 |
| EK 396-00 |142 | EK 445-13 |184 | EK 489-00 |206 | EK 550-25 |176 |
| EK 396-01 |142 | EK 446-15 |184 | EK 489-01 |206 | EK 551-25 |176 |
| EK 396-02 |142 | EK 452-20 |184 | EK 489-02 |206 | EK 552-30 |176 |
| EK 396-03 |142 | EK 454-27 |185 | EK 490-09 |201 | EK 552-40 |176 |
| EK 396-04 |142 | EK 455-27 |185 | EK 491-18 |203 | EK 552-50 |176 |
| EK 397-00 |142 | EK 456-27 |185 | EK 491-20 |204 | EK 554-30 |176 |

| Catalog Code | Page | Catalog Code | Page | Catalog Code | Page | Catalog Code | Page |
|--------------|----------|--------------|---------|--------------|---------|--------------|---------|
| EK 554-45 |176 | FO 113-14 |49 | FO 230-17 |53 | FO 408-17 |58 |
| EK 554-50 |176 | FO 113-16 |49 | FO 232-17 |53 | FO 409-18 |58 |
| EK 555-29 |176 | FO 120-10 |47 | FO 233-17 |53 | FO 410-16 |59 |
| EK 650-00 |233 | FO 120-11 |47 | FO 240-17 |53 | FO 410-20 |59 |
| EK 650-01 |233 | FO 120-13 |47 | FO 242-17 |53 | FO 410-24 |59 |
| EK 650-02 |233 | FO 120-14 |47 | FO 243-17 |53 | FO 411-16 |59 |
| EK 650-03 |233 | FO 120-16 |47 | FO 250-20 |53 | FO 411-20 |59 |
| EK 650-04 |233 | FO 120-18 |47 | FO 250-25 |53 | FO 411-24 |59 |
| EK 937-01 |211 | FO 120-20 |47 | FO 300-18 |53 | FO 412-16 |59 |
| EK 937-02 |211 | FO 120-25 |47 | FO 301-18 |53 | FO 412-20 |59 |
| EK 937-03 |211 | FO 120-30 |47 | FO 310-18 |53 | FO 412-24 |59 |
| EK 937-04 |211 | FO 121-14 |52 | FO 311-18 |53 | FO 413-16 |59 |
| EK 937-05 |211 | FO 130-13 |48 | FO 320-17 |54 | FO 413-20 |59 |
| EK 938-00 |211 | FO 130-14 |48 | FO 321-17 |54 | FO 413-24 |59 |
| EK 939-00 |211 | FO 130-16 |48 | FO 325-17 |54 | FO 501-23 |55 |
| EK 940-00 |211 | FO 130-18 |48 | FO 350-18 |54 | FO 502-23 |55 |
| FO 100-10 |47 | FO 130-20 |48 | FO 350-21 |54 | FO 503-23 |55 |
| FO 100-11 |47 | FO 130-25 |48 | FO 350-25 |54 | FO 510-15 |52 |
| FO 100-13 |47 | FO 130-30 |48 | FO 360-18 |54 | FO 511-10 |43 |
| FO 100-14 |47 | FO 131-14 |52 | FO 360-21 |54 | FO 512-10 |43 |
| FO 100-16 |47 | FO 200-12 |50 | FO 360-25 |54 | FO 513-10 |43 |
| FO 100-18 |47 | FO 200-15 |50 | FO 380-15 |54 | FO 514-10 |43 |
| FO 100-20 |47 | FO 201-12 |50 | FO 380-20 |54 | FO 515-10 |43 |
| FO 100-25 |47 | FO 202-12 |50 | FO 389-14 |54 | FO 517-15 |55 |
| FO 100-30 |47 | FO 202-15 |50 | FO 399-14 |57 | FO 517-20 |55 |
| FO 110-10 |48 | FO 203-12 |50 | FO 399-18 |57 | FO 517-25 |55 |
| FO 110-11 |48 | FO 203-15 |50 | FO 399-20 |57 | FO 518-14 |56 |
| FO 110-13 |48 | FO 207-12 |51 | FO 399-25 |57 | FO 518-16 |56 |
| FO 110-14 |48 | FO 208-12 |51 | FO 400-15 |57 | FO 518-20 |56 |
| FO 110-16 |48 | FO 209-12 |51 | FO 400-18 |57 | FO 519-14 |56 |
| FO 110-18 |48 | FO 209-15 |51 | FO 400-20 |57 | FO 520-18 |56 |
| FO 110-20 |48 | FO 220-12 |51 | FO 400-23 |57 | FO 525-01 |42 |
| FO 110-25 |48 | FO 221-12 |51 | FO 400-25 |57 | FO 525-02 |42 |
| FO 110-30 |48 | FO 222-07 |51 | FO 401-14 |59 | FO 525-03 |42 |
| FO 111-11 |49 | FO 222-09 |51 | FO 401-16 |59 | FO 525-04 |42 |
| FO 111-13 |49 | FO 223-09 |51 | FO 401-18 |59 | FO 525-05 |42 |
| FO 111-14 |49 | FO 225-15 |52 | FO 401-20 |59 | FO 526-01 |42 |
| FO 111-16 |49 | FO 226-12 |52 | FO 401-25 |59 | FO 526-02 |42 |
| FO 111-18 |49 | FO 226-15 |52 | FO 403-15 |58 | FO 526-03 |42 |
| FO 111-20 |49 | FO 227-12 |52 | FO 405-12 |57 | FO 530-00 |43 |
| FO 111-25 |49 | FO 227-15 |52 | FO 405-15 |57 | FO 530-01 |43 |
| FO 111-30 |49 | FO 228-12 |52 | FO 406-12 |57 | FO 530-02 |43 |
| FO 112-14 |49 | FO 228-15 |52 | FO 406-15 |57 | FO 530-03 |43 |
| FO 112-16 |49 | FO 229-12 |52 | FO 407-15 |58 | FO 530-04 |43 |
| FO 112-20 |49 | FO 229-15 |52 | FO 407-17 |58 | FO 530-05 |43 |



| Catalog Code | Page | Catalog Code | Page | Catalog Code | Page | Catalog Code | Page |
|--------------|----------|--------------|---------|--------------|----------|--------------|----------|
| FO 530-07 |43 | FO 962-18 |46 | FO 996-21 |44 | HM 405-30 |88 |
| FO 530-08 |43 | FO 962-20 |46 | HM 160-14 |415 | HM 406-14 |89 |
| FO 530-09 |43 | FO 963-18 |46 | HM 353-19 |217 | HM 406-16 |89 |
| FO 530-10 |43 | FO 963-20 |46 | HM 354-20 |217 | HM 406-18 |89 |
| FO 608-12 |44 | FO 964-18 |46 | HM 355-23 |217 | HM 406-20 |89 |
| FO 609-12 |44 | FO 964-25 |46 | HM 370-16 |214 | HM 406-22 |89 |
| FO 610-15 |44 | FO 980-15 |45 | HM 370-20 |214 | HM 406-24 |89 |
| FO 611-15 |44 | FO 980-18 |45 | HM 370-25 |214 | HM 406-26 |89 |
| FO 612-18 |44 | FO 980-21 |45 | HM 370-30 |214 | HM 406-30 |89 |
| FO 613-18 |44 | FO 981-15 |45 | HM 371-16 |216 | HM 408-18 |81 |
| FO 700-11 |352 | FO 981-18 |45 | HM 371-21 |216 | HM 410-16 |216 |
| FO 700-12 |352 | FO 981-21 |45 | HM 372-19 |217 | HM 410-18 |216 |
| FO 700-15 |369 | FO 982-18 |45 | HM 372-23 |217 | HM 410-20 |216 |
| FO 700-18 |369 | FO 983-15 |45 | HM 390-15 |215 | HM 410-24 |216 |
| FO 702-13 |352 | FO 983-18 |45 | HM 390-20 |215 | HM 415-14 |92 |
| FO 703-14 |352 | FO 983-21 |45 | HM 390-25 |215 | HM 415-18 |92 |
| FO 705-16 |352 | FO 984-15 |45 | HM 400-13 |214 | HM 418-19 |81 |
| FO 705-18 |352 | FO 984-18 |45 | HM 400-14 |86 | HM 419-19 |81 |
| FO 705-20 |352 | FO 984-21 |45 | HM 400-15 |214 | HM 420-01 |94 |
| FO 706-14 |369 | FO 985-15 |45 | HM 400-16 |86 | HM 420-02 |94 |
| FO 707-16 |369 | FO 985-18 |45 | HM 400-18 |86 | HM 420-03 |94 |
| FO 710-20 |369 | FO 985-21 |45 | HM 400-19 |215 | HM 420-04 |94 |
| FO 950-16 |60 | FO 986-15 |45 | HM 400-20 |86 | HM 420-05 |94 |
| FO 950-24 |60 | FO 986-18 |45 | HM 400-22 |86 | HM 420-06 |94 |
| FO 951-16 |60 | FO 986-21 |45 | HM 400-24 |86 | HM 420-07 |94 |
| FO 951-20 |60 | FO 990-15 |44 | HM 400-26 |86 | HM 420-18 |98 |
| FO 951-24 |60 | FO 990-18 |44 | HM 400-30 |86 | HM 420-28 |98 |
| FO 951-30 |60 | FO 990-21 |44 | HM 401-14 |87 | HM 421-01 |94 |
| FO 952-16 |60 | FO 991-15 |44 | HM 401-15 |214 | HM 421-02 |94 |
| FO 952-20 |60 | FO 991-18 |44 | HM 401-16 |87 | HM 421-03 |94 |
| FO 952-24 |60 | FO 991-21 |44 | HM 401-18 |87 | HM 421-04 |94 |
| FO 952-30 |60 | FO 992-15 |44 | HM 401-19 |214 | HM 421-05 |94 |
| FO 953-16 |60 | FO 992-18 |44 | HM 401-20 |87 | HM 421-06 |94 |
| FO 953-20 |60 | FO 992-21 |44 | HM 401-22 |87 | HM 421-07 |94 |
| FO 953-24 |60 | FO 993-15 |44 | HM 401-24 |87 | HM 421-15 |217 |
| FO 953-30 |60 | FO 993-18 |44 | HM 401-25 |214 | HM 421-20 |217 |
| FO 954-16 |61 | FO 993-21 |44 | HM 401-26 |87 | HM 422-15 |80 |
| FO 954-20 |61 | FO 994-15 |44 | HM 401-30 |87 | HM 423-15 |80 |
| FO 954-24 |61 | FO 994-18 |44 | HM 405-14 |88 | HM 424-12 |78 |
| FO 954-30 |61 | FO 994-21 |44 | HM 405-16 |88 | HM 424-13 |92 |
| FO 960-15 |61 | FO 995-15 |44 | HM 405-18 |88 | HM 424-14 |78 |
| FO 960-20 |61 | FO 995-18 |44 | HM 405-20 |88 | HM 425-14 |78 |
| FO 960-24 |61 | FO 995-21 |44 | HM 405-22 |88 | HM 425-16 |412 |
| FO 961-18 |46 | FO 996-15 |44 | HM 405-24 |88 | HM 426-18 |93 |
| FO 961-20 |46 | FO 996-18 |44 | HM 405-26 |88 | HM 426-20 |93 |

| Catalog Code | Page | Catalog Code | Page | Catalog Code | Page | Catalog Code | Page |
|--------------|----------|--------------|----------|--------------|---------|--------------|--------------|
| HM 426-21 |93 | HM 441-20 |90 | HM 471-16 |80 | HM 520-01 |92 |
| HM 426-22 |93 | HM 442-12 |77 | HM 476-03 |72 | HM 520-02 |92 |
| HM 427-13 |85 | HM 442-14 |77 | HM 476-05 |72 | HM 520-15 |95 |
| HM 427-14 |85 | HM 442-15 |218 | HM 476-06 |72 | HM 520-19 |95 |
| HM 427-16 |85 | HM 442-18 |218 | HM 477-03 |72 | HM 520-22 |95 |
| HM 428-13 |85 | HM 443-12 |77 | HM 477-05 |72 | HM 521-15 |95 |
| HM 428-14 |85 | HM 443-14 |77 | HM 477-06 |72 | HM 521-19 |95 |
| HM 428-16 |85 | HM 443-15 |218 | HM 480-00 |74 | HM 521-22 |99 |
| HM 429-13 |85 | HM 443-18 |218 | HM 480-04 |73 | HM 521-25 |99 |
| HM 429-14 |85 | HM 444-20 |82 | HM 480-05 |73 | HM 521-28 |99 |
| HM 429-16 |85 | HM 444-26 |82 | HM 480-06 |73 | HM 522-18 |92 |
| HM 430-01 |80 | HM 445-18 |81 | HM 480-07 |73 | HM 525-23 |95 |
| HM 430-02 |80 | HM 445-20 |82 | HM 480-09 |73 | HM 526-28 |83 |
| HM 430-13 |84 | HM 445-21 |81 | HM 481-04 |73 | HM 527-28 |83 |
| HM 430-14 |84 | HM 445-26 |82 | HM 481-05 |73 | HM 530-20 |96 |
| HM 430-15 |84 | HM 446-18 |81 | HM 481-06 |73 | HM 530-24 |96 |
| HM 430-18 |84 | HM 446-20 |82 | HM 481-07 |73 | HM 530-28 |96 |
| HM 430-20 |84 | HM 446-21 |81 | HM 481-09 |73 | HM 531-28 |98 |
| HM 431-01 |401 | HM 446-26 |82 | HM 482-00 |70 | HM 532-14 |93 |
| HM 431-02 |401 | HM 447-18 |81 | HM 482-01 |70 | HM 532-16 |93 |
| HM 431-13 |84 | HM 447-20 |82 | HM 482-02 |70 | HM 532-18 |93 |
| HM 431-14 |84 | HM 447-21 |81 | HM 482-03 |70 | HM 532-20 |93 |
| HM 431-15 |84 | HM 447-26 |82 | HM 483-01 |70 | HM 532-23 |93 |
| HM 431-18 |84 | HM 448-21 |81 | HM 483-03 |70 | HM 532-28 |93 |
| HM 431-20 |84 | HM 450-15 |79 | HM 483-04 |70 | HM 543-20 |231 |
| HM 432-10 |77 | HM 451-15 |79 | HM 483-05 |70 | HM 543-22 |231 |
| HM 432-13 |85 | HM 452-15 |79 | HM 484-00 |71 | HM 543-24 |231 |
| HM 432-14 |85 | HM 453-15 |79 | HM 484-01 |71 | HM 552-19 |96 |
| HM 432-16 |85 | HM 454-14 |78 | HM 484-02 |71 | HM 555-01 |219 |
| HM 433-10 |77 | HM 455-14 |78 | HM 484-03 |71 | HM 555-02 |219 |
| HM 436-10 |77 | HM 460-14 |78 | HM 484-04 |71 | HM 555-21 |219 |
| HM 436-12 |77 | HM 461-14 |78 | HM 505-01 |82 | HM 555-24 |219 |
| HM 437-10 |77 | HM 462-16 |80 | HM 505-02 |82 | HM 556-21 |219 |
| HM 437-12 |77 | HM 463-16 |80 | HM 505-03 |82 | HM 556-23 |219 |
| HM 438-10 |77 | HM 466-14 |79 | HM 506-22 |90 | HM 561-25 |105,232 |
| HM 438-12 |77 | HM 467-14 |79 | HM 507-23 |90 | HM 562-23 |102 |
| HM 439-10 |77 | HM 468-14 |79 | HM 508-24 |90 | HM 563-23 |102 |
| HM 439-12 |77 | HM 469-14 |79 | HM 509-24 |90 | HM 568-01 |218 |
| HM 440-12 |77 | HM 470-01 |72 | HM 510-24 |83 | HM 568-02 |218 |
| HM 440-14 |77 | HM 470-02 |72 | HM 515-01 |97 | HM 571-19 |103 |
| HM 440-16 |90 | HM 470-03 |72 | HM 515-02 |97 | HM 571-21 |103 |
| HM 440-20 |90 | HM 470-16 |80 | HM 515-03 |97 | HM 571-23 |103 |
| HM 441-12 |77 | HM 471-01 |72 | HM 515-04 |97 | HM 572-19 |103 |
| HM 441-14 |77 | HM 471-02 |72 | HM 516-29 |99 | HM 572-21 |103 |
| HM 441-16 |90 | HM 471-03 |72 | HM 517-29 |99 | HM 572-23 |103 |



| Catalog Code | Page | Catalog Code | Page | Catalog Code | Page | Catalog Code | Page |
|--------------|--------------|--------------|----------|--------------|----------|--------------|----------|
| HM 583-23 |91 | HO 204-04 |133 | HO 333-30 |362 | KA 465-18 |224 |
| HM 584-24 |91 | HO 205-16 |133 | HO 346-01 |362 | KA 465-20 |224 |
| HM 585-21 |105,232 | HO 206-01 |133 | HO 346-02 |362 | KA 465-25 |224 |
| HM 590-21 |102 | HO 206-02 |133 | HO 347-01 |362 | KA 465-26 |224 |
| HM 591-21 |102 | HO 207-01 |134 | HO 347-02 |362 | KA 608-01 |200 |
| HM 600-00 |104 | HO 207-02 |134 | HO 360-01 |363 | KA 650-01 |163 |
| HM 600-01 |104 | HO 208-01 |134 | HO 360-02 |363 | KA 650-02 |163 |
| HM 600-02 |104 | HO 208-02 |134 | HO 361-03 |363 | KA 651-01 |163 |
| HM 600-03 |104 | HO 215-20 |134 | HO 361-06 |363 | KB 101-08 |354 |
| HM 601-00 |104 | HO 220-22 |390 | HO 361-10 |363 | KB 102-06 |354 |
| HM 601-01 |104 | HO 300-01 |360 | HO 362-03 |363 | KB 103-02 |354 |
| HM 601-02 |104 | HO 300-02 |360 | HO 362-06 |363 | KB 104-07 |354 |
| HM 601-03 |104 | HO 300-03 |360 | HO 362-10 |363 | KB 105-02 |354 |
| HM 700-14 |100 | HO 300-04 |360 | HO 363-04 |363 | KB 106-03 |354 |
| HM 701-18 |100 | HO 304-03 |360 | HO 363-10 |363 | KB 107-03 |354 |
| HM 702-20 |100 | HO 304-06 |360 | HO 364-04 |363 | KB 108-19 |354 |
| HM 703-20 |101 | HO 304-10 |360 | HO 364-10 |363 | KB 111-06 |355 |
| HM 704-20 |101 | HO 304-12 |360 | HO 365-02 |364 | KB 111-08 |354 |
| HM 710-20 |101 | HO 304-15 |360 | HO 365-03 |364 | KB 112-01 |354 |
| HM 711-20 |101 | HO 304-20 |360 | HO 365-04 |364 | KB 112-02 |354 |
| HM 815-15 |413 | HO 304-25 |360 | HS 115-00 |264 | KB 113-01 |354 |
| HM 815-18 |413 | HO 305-03 |360 | KA 100-00 |76 | KB 120-01 |358 |
| HM 815-20 |413 | HO 305-06 |360 | KA 100-01 |75 | KB 120-02 |358 |
| HM 816-18 |413 | HO 305-12 |360 | KA 100-02 |75 | KB 120-03 |358 |
| HM 816-20 |413 | HO 305-15 |360 | KA 100-04 |75 | KB 121-01 |356 |
| HM 835-16 |67 | HO 305-20 |360 | KA 100-05 |75 | KB 121-02 |356 |
| HM 840-13 |67 | HO 305-25 |360 | KA 100-06 |75 | KB 121-03 |356 |
| HM 840-15 |67 | HO 306-05 |360 | KA 100-07 |75 | KB 121-04 |356 |
| HM 840-20 |67 | HO 306-10 |360 | KA 100-08 |75 | KB 121-06 |357 |
| HM 860-08 |67 | HO 310-04 |361 | KA 100-09 |75 | KB 121-07 |357 |
| HM 860-11 |67 | HO 310-06 |361 | KA 100-10 |75 | KB 121-08 |357 |
| HM 860-13 |67 | HO 310-08 |361 | KA 100-11 |75 | KB 130-00 |346 |
| HM 860-15 |67 | HO 310-10 |361 | KA 100-12 |75 | KB 130-01 |346 |
| HM 861-13 |67 | HO 313-12 |361 | KA 320-22 |221 | KB 130-02 |346 |
| HM 880-13 |67 | HO 317-10 |361 | KA 320-25 |221 | KB 130-03 |346 |
| HO 200-01 |132 | HO 317-14 |361 | KA 320-28 |221 | KB 130-04 |346 |
| HO 200-02 |132 | HO 317-16 |361 | KA 321-22 |222 | KB 131-00 |346 |
| HO 201-15 |132 | HO 317-20 |361 | KA 321-25 |222 | KB 131-01 |346 |
| HO 202-13 |132 | HO 317-26 |361 | KA 321-28 |222 | KB 131-02 |346 |
| HO 203-01 |132 | HO 317-28 |361 | KA 322-01 |220 | KB 131-03 |346 |
| HO 203-02 |132 | HO 317-30 |361 | KA 322-02 |220 | KB 161-00 |386 |
| HO 203-03 |132 | HO 322-01 |362 | KA 340-15 |223 | KB 184-01 |353 |
| HO 204-01 |133 | HO 322-02 |362 | KA 410-20 |223 | KB 184-02 |353 |
| HO 204-02 |133 | HO 322-03 |362 | KA 410-27 |223 | KB 185-02 |374 |
| HO 204-03 |133 | HO 332-20 |362 | KA 411-35 |223 | KB 200-01 |355 |

| Catalog Code | Page | Catalog Code | Page | Catalog Code | Page | Catalog Code | Page |
|--------------|----------|--------------|----------|--------------|----------|--------------|----------|
| KB 200-03 |355 | KB 380-01 |408 | KB 453-02 |370 | KB 498-15 |274 |
| KB 200-05 |355 | KB 380-02 |408 | KB 453-03 |370 | KB 499-04 |385 |
| KB 200-07 |355 | KB 380-03 |408 | KB 453-04 |370 | KB 499-05 |385 |
| KB 202-01 |359 | KB 380-04 |408 | KB 460-20 |382 | KB 499-06 |385 |
| KB 202-02 |359 | KB 380-05 |408 | KB 460-21 |382 | KB 499-08 |385 |
| KB 202-03 |359 | KB 380-06 |408 | KB 461-20 |382 | KB 503-02 |384 |
| KB 202-04 |359 | KB 380-07 |408 | KB 462-20 |380 | KB 503-04 |384 |
| KB 220-15 |412 | KB 410-01 |377 | KB 463-20 |284 | KB 503-06 |384 |
| KB 220-20 |412 | KB 410-02 |377 | KB 480-14 |391 | KB 503-08 |384 |
| KB 220-25 |412 | KB 410-03 |377 | KB 481-14 |391 | KB 503-10 |384 |
| KB 250-13 |366 | KB 411-03 |377 | KB 482-14 |391 | KB 503-12 |384 |
| KB 250-16 |366 | KB 411-04 |377 | KB 483-08 |391 | KB 504-16 |384 |
| KB 251-16 |366 | KB 411-05 |377 | KB 484-12 |391 | KB 505-14 |384 |
| KB 252-16 |366 | KB 415-20 |375 | KB 485-20 |391 | KB 505-21 |387 |
| KB 255-14 |366 | KB 416-21 |375 | KB 486-16 |390 | KB 507-16 |387 |
| KB 259-14 |366 | KB 420-15 |383 | KB 487-12 |392 | KB 510-18 |387 |
| KB 260-01 |367 | KB 421-15 |383 | KB 488-16 |392 | KB 511-18 |387 |
| KB 260-02 |367 | KB 422-17 |383 | KB 489-15 |392 | KB 515-01 |388 |
| KB 260-03 |367 | KB 423-17 |383 | KB 491-04 |384 | KB 515-02 |388 |
| KB 260-04 |367 | KB 428-01 |374 | KB 491-06 |384 | KB 515-03 |388 |
| KB 262-01 |368 | KB 428-02 |374 | KB 491-08 |384 | KB 515-04 |388 |
| KB 262-02 |368 | KB 430-01 |374 | KB 491-10 |384 | KB 515-05 |388 |
| KB 262-03 |368 | KB 430-02 |374 | KB 491-12 |384 | KB 516-01 |389 |
| KB 262-04 |368 | KB 430-03 |374 | KB 492-04 |384 | KB 516-02 |389 |
| KB 262-06 |368 | KB 432-01 |371 | KB 492-07 |384 | KB 517-08 |389 |
| KB 304-00 |404 | KB 432-02 |371 | KB 492-09 |384 | KB 518-08 |389 |
| KB 304-01 |404 | KB 432-03 |371 | KB 492-10 |384 | KB 519-08 |389 |
| KB 350-15 |378 | KB 433-01 |371 | KB 492-12 |384 | KB 520-08 |389 |
| KB 350-18 |379 | KB 433-02 |371 | KB 493-06 |384 | KB 528-02 |394 |
| KB 350-19 |379 | KB 434-01 |372 | KB 494-03 |385 | KB 528-15 |394 |
| KB 351-19 |379 | KB 437-01 |372 | KB 494-04 |385 | KB 529-15 |394 |
| KB 353-18 |379 | KB 437-02 |372 | KB 495-01 |385 | KB 530-00 |399 |
| KB 354-18 |379 | KB 437-03 |372 | KB 495-02 |385 | KB 530-29 |398 |
| KB 355-18 |380 | KB 437-04 |372 | KB 495-03 |385 | KB 530-33 |398 |
| KB 356-19 |381 | KB 438-01 |372 | KB 497-10 |385 | KB 530-38 |398 |
| KB 357-19 |292 | KB 450-01 |370 | KB 497-12 |385 | KB 530-40 |398 |
| KB 358-13 |381 | KB 450-02 |370 | KB 497-14 |385 | KB 530-46 |398 |
| KB 358-19 |381 | KB 450-03 |370 | KB 497-16 |385 | KB 531-00 |395 |
| KB 359-18 |380 | KB 450-04 |370 | KB 498-02 |274 | KB 531-18 |398 |
| KB 362-21 |380 | KB 450-05 |370 | KB 498-03 |274 | KB 531-22 |398 |
| KB 364-02 |379 | KB 451-01 |370 | KB 498-04 |274 | KB 531-25 |398 |
| KB 364-03 |379 | KB 451-02 |370 | KB 498-06 |274 | KB 532-00 |395 |
| KB 367-16 |383 | KB 451-03 |370 | KB 498-08 |274 | KB 533-00 |396 |
| KB 368-16 |383 | KB 452-01 |370 | KB 498-10 |274 | KB 533-01 |396 |
| KB 380-00 |408 | KB 453-01 |370 | KB 498-12 |274 | KB 533-02 |397 |



| Catalog Code | Page | Catalog Code | Page | Catalog Code | Page | Catalog Code | Page |
|--------------|----------|--------------|----------|--------------|----------|--------------|---------|
| KB 534-00 |397 | KB 640-08 |407 | KL 203-10 |273 | MA 101-14 |12 |
| KB 534-25 |399 | KB 640-09 |407 | KL 203-12 |273 | MA 101-16 |12 |
| KB 534-29 |399 | KB 640-10 |407 | KL 203-15 |273 | MA 101-18 |12 |
| KB 534-32 |399 | KB 640-11 |407 | KL 203-20 |273 | MA 101-20 |12 |
| KB 542-20 |401 | KB 640-12 |407 | KL 203-25 |273 | MA 102-11 |13 |
| KB 544-01 |401 | KB 700-12 |409 | KL 204-10 |273 | MA 102-13 |13 |
| KB 552-21 |402 | KB 701-13 |409 | KL 204-12 |273 | MA 102-14 |13 |
| KB 553-23 |402 | KB 800-01 |373 | KL 204-15 |273 | MA 102-16 |13 |
| KB 554-23 |402 | KB 800-02 |373 | KL 204-20 |273 | MA 102-18 |13 |
| KB 558-01 |386 | KB 800-03 |373 | KL 204-25 |273 | MA 102-20 |13 |
| KB 558-02 |386 | KB 900-18 |278 | KL 250-04 |275 | MA 103-11 |13 |
| KB 558-03 |386 | KB 901-18 |278 | KL 250-08 |275 | MA 103-13 |13 |
| KB 601-18 |403 | KB 902-18 |278 | KL 250-10 |275 | MA 103-14 |13 |
| KB 602-19 |403 | KB 902-24 |279 | KL 250-13 |275 | MA 103-16 |13 |
| KB 610-25 |404 | KB 906-24 |279 | KL 250-15 |275 | MA 103-18 |13 |
| KB 611-25 |404 | KL 100-06 |270 | KL 250-18 |275 | MA 103-20 |13 |
| KB 612-27 |404 | KL 100-13 |270 | KL 250-20 |275 | MA 104-11 |14 |
| KB 613-03 |404 | KL 100-19 |270 | KL 250-25 |275 | MA 104-13 |14 |
| KB 614-03 |404 | KL 100-25 |270 | KL 250-30 |275 | MA 104-14 |14 |
| KB 620-01 |405 | KL 100-32 |270 | KL 250-38 |275 | MA 104-16 |14 |
| KB 620-02 |405 | KL 101-06 |270 | KL 250-44 |275 | MA 105-11 |14 |
| KB 620-03 |405 | KL 101-13 |270 | KL 250-50 |275 | MA 105-13 |14 |
| KB 620-04 |405 | KL 101-19 |270 | KL 251-08 |275 | MA 105-14 |14 |
| KB 620-05 |405 | KL 101-25 |270 | KL 251-13 |275 | MA 105-16 |14 |
| KB 621-01 |405 | KL 102-06 |271 | KL 251-20 |275 | MA 121-17 |16 |
| KB 621-02 |405 | KL 102-13 |271 | KL 251-25 |275 | MA 125-14 |15 |
| KB 621-03 |405 | KL 102-19 |271 | KL 251-30 |275 | MA 125-17 |15 |
| KB 621-04 |405 | KL 102-25 |271 | KL 251-38 |275 | MA 125-23 |15 |
| KB 621-05 |405 | KL 102-32 |271 | KL 406-05 |276 | MA 126-14 |15 |
| KB 621-06 |405 | KL 103-06 |271 | KL 406-10 |276 | MA 126-17 |15 |
| KB 630-00 |406 | KL 103-13 |271 | KL 406-15 |276 | MA 126-23 |15 |
| KB 631-01 |406 | KL 103-19 |271 | KL 407-05 |276 | MA 126-28 |16 |
| KB 631-02 |406 | KL 103-25 |271 | KL 407-10 |276 | MA 127-15 |17 |
| KB 631-03 |406 | KL 103-32 |271 | KL 407-15 |276 | MA 127-17 |17 |
| KB 631-04 |406 | KL 200-10 |272 | KL 600-20 |278 | MA 127-19 |17 |
| KB 631-10 |406 | KL 200-12 |272 | KL 600-22 |278 | MA 127-21 |17 |
| KB 631-11 |406 | KL 200-15 |272 | KL 602-24 |279 | MA 128-15 |17 |
| KB 640-00 |407 | KL 200-20 |272 | MA 100-11 |12 | MA 128-17 |17 |
| KB 640-01 |407 | KL 200-25 |272 | MA 100-13 |12 | MA 128-19 |17 |
| KB 640-02 |407 | KL 201-10 |272 | MA 100-14 |12 | MA 128-21 |17 |
| KB 640-03 |407 | KL 201-12 |272 | MA 100-16 |12 | MA 134-16 |25 |
| KB 640-04 |407 | KL 201-15 |272 | MA 100-18 |12 | MA 135-16 |25 |
| KB 640-05 |407 | KL 201-20 |272 | MA 100-20 |12 | MA 136-19 |32 |
| KB 640-06 |407 | KL 201-25 |272 | MA 101-11 |12 | MA 136-22 |32 |
| KB 640-07 |407 | KL 203-08 |273 | MA 101-13 |12 | MA 140-20 |33 |

| Catalog Code | Page | Catalog Code | Page | Catalog Code | Page | Catalog Code | Page |
|--------------|---------|--------------|----------|--------------|-------------|--------------|----------|
| MA 140-23 |33 | MA 233-15 |22 | MA 464-11 |26 | MA 862-23 |33 |
| MA 143-20 |33 | MA 233-18 |22 | MA 465-11 |26 | MA 865-11 |18 |
| MA 143-23 |33 | MA 234-25 |28 | MA 466-11 |26 | MA 866-11 |18 |
| MA 148-24 |32 | MA 234-45 |28 | MA 561-09 |24 | MA 867-14 |18 |
| MA 149-14 |18 | MA 234-60 |28 | MA 561-10 |24 | MA 868-14 |18 |
| MA 150-14 |18 | MA 235-16 |28 | MA 561-11 |24 | MA 869-18 |19 |
| MA 155-11 |18 | MA 236-16 |28 | MA 562-09 |24 | MA 869-20 |19 |
| MA 156-11 |18 | MA 237-01 |27 | MA 562-10 |24 | MA 869-23 |19 |
| MA 200-18 |19 | MA 237-02 |27 | MA 562-11 |24 | MA 869-25 |19 |
| MA 200-20 |19 | MA 237-03 |27 | MA 565-11 |22 | MA 869-28 |19 |
| MA 200-23 |19 | MA 237-04 |27 | MA 566-11 |22 | MA 869-30 |19 |
| MA 200-25 |19 | MA 237-05 |27 | MA 570-10 |31 | MA 870-18 |19 |
| MA 200-28 |19 | MA 238-01 |27 | MA 573-11 |24 | MA 870-20 |19 |
| MA 200-30 |19 | MA 238-02 |27 | MA 574-11 |24 | MA 870-23 |19 |
| MA 201-18 |19 | MA 238-03 |27 | MA 575-10 |24 | MA 870-25 |19 |
| MA 201-20 |19 | MA 238-04 |27 | MA 576-10 |24 | MA 870-28 |19 |
| MA 201-23 |19 | MA 238-05 |27 | MA 604-12 |328 | MA 870-30 |19 |
| MA 201-25 |19 | MA 239-01 |27 | MA 620-23 |332 | MA 871-45 |29 |
| MA 201-28 |19 | MA 239-02 |27 | MA 636-14 |38 | MA 871-60 |29 |
| MA 201-30 |19 | MA 239-03 |27 | MA 636-18 |38 | MA 872-25 |29 |
| MA 210-14 |20 | MA 239-04 |27 | MA 636-20 |38 | MA 872-45 |29 |
| MA 211-14 |20 | MA 239-05 |27 | MA 637-20 |332 | MA 872-60 |29 |
| MA 212-14 |21 | MA 240-19 |28 | MA 640-24 |40,333 | MA 873-16 |18 |
| MA 213-14 |21 | MA 241-19 |28 | MA 641-24 |40,333 | MA 874-16 |18 |
| MA 214-20 |20 | MA 246-22 |30 | MA 710-13 |26 | MA 876-14 |20 |
| MA 214-23 |20 | MA 247-17 |30 | MA 711-13 |26 | MA 877-14 |21 |
| MA 215-18 |20 | MA 255-17 |21 | MA 850-14 |12 | MA 878-14 |21 |
| MA 215-20 |20 | MA 309-23 |30 | MA 851-14 |12 | MA 879-18 |20 |
| MA 215-23 |20 | MA 316-21 |37 | MA 852-14 |13 | MA 880-18 |20 |
| MA 218-15 |22 | MA 317-21 |37 | MA 853-14 |13 | MA 880-20 |20 |
| MA 219-15 |22 | MA 350-12 |23 | MA 854-14 |14 | MA 880-23 |20 |
| MA 220-16 |18 | MA 350-19 |23 | MA 855-14 |14 | MA 880-25 |20 |
| MA 221-16 |18 | MA 351-19 |23 | MA 856-14 |15 | MA 880-28 |20 |
| MA 222-13 |31 | MA 354-15 |22 | MA 856-17 |15 | MA 883-17 |21 |
| MA 223-19 |30 | MA 446-22 |375 | MA 856-23 |15 | MA 884-13 |26 |
| MA 224-10 |18 | MA 447-13 |376 | MA 857-14 |15 | MA 885-13 |26 |
| MA 225-10 |18 | MA 450-16 |376 | MA 857-17 |15 | MA 886-11 |24 |
| MA 228-14 |25 | MA 451-18 |376 | MA 857-23 |15 | MA 886-14 |25 |
| MA 229-14 |25 | MA 452-19 |376 | MA 858-01 |34 | MA 887-11 |24 |
| MA 231-12 |23 | MA 453-14 |35 | MA 858-02 |34 | MA 887-14 |25 |
| MA 231-15 |23 | MA 453-22 |35 | MA 859-15 |17 | MA 889-12 |328 |
| MA 231-18 |23 | MA 456-10 |36 | MA 859-17 |17 | MA 890-18 |38 |
| MA 231-20 |23 | MA 458-16 |36 | MA 860-15 |17 | MA 891-11 |18 |
| MA 232-15 |22 | MA 462-11 |26 | MA 860-17 |17 | MA 891-14 |18 |
| MA 232-18 |22 | MA 463-11 |26 | MA 861-23 |33 | MA 891-18 |19 |

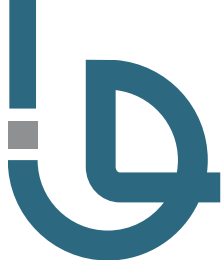

| Catalog Code | Page | Catalog Code | Page | Catalog Code | Page | Catalog Code | Page |
|--------------|---------|--------------|----------|--------------|----------|--------------|----------|
| MA 891-20 |19 | MA 975-03 |10 | OF 451-17 |326 | OG 110-07 |262 |
| MA 891-23 |19 | MA 975-04 |10 | OF 452-19 |326 | OG 110-08 |262 |
| MA 891-25 |19 | MA 975-05 |10 | OF 455-18 |327 | OG 110-10 |262 |
| MA 891-28 |19 | MA 976-01 |10 | OF 456-20 |327 | OG 110-12 |262 |
| MA 892-11 |18 | MA 976-02 |10 | OF 457-02 |325 | OG 110-14 |262 |
| MA 892-14 |18 | MA 976-03 |10 | OF 457-03 |325 | OG 110-15 |262 |
| MA 892-18 |19 | MA 976-04 |10 | OF 457-04 |325 | OG 110-16 |262 |
| MA 892-20 |19 | MA 976-05 |10 | OF 665-00 |318 | OG 110-18 |262 |
| MA 892-23 |19 | MA 977-01 |11 | OF 720-20 |321 | OG 110-19 |262 |
| MA 892-25 |19 | MA 977-02 |11 | OF 720-25 |321 | OG 110-21 |262 |
| MA 892-28 |19 | MA 977-03 |11 | OF 721-20 |321 | OG 110-23 |262 |
| MA 893-11 |24 | MA 977-04 |11 | OF 721-25 |321 | OG 200-34 |262 |
| MA 893-18 |19 | MA 977-05 |11 | OF 722-20 |321 | OG 200-39 |262 |
| MA 893-20 |19 | MA 978-01 |11 | OF 722-25 |321 | OG 202-26 |262 |
| MA 893-23 |19 | MA 978-02 |11 | OF 723-20 |321 | OG 202-28 |262 |
| MA 894-11 |24 | MA 978-03 |11 | OF 723-25 |321 | OG 220-01 |292 |
| MA 894-18 |19 | MA 978-04 |11 | OF 724-20 |321 | OG 220-02 |292 |
| MA 894-20 |19 | MA 978-05 |11 | OF 724-25 |321 | OG 220-17 |292 |
| MA 894-23 |19 | MA 984-15 |9 | OF 725-20 |321 | OG 221-19 |292 |
| MA 894-25 |19 | MA 984-18 |9 | OF 725-25 |321 | OG 222-01 |292 |
| MA 896-11 |18 | MA 984-21 |9 | OF 726-20 |321 | OG 222-02 |292 |
| MA 896-14 |18 | MA 985-15 |9 | OF 726-25 |321 | OG 248-01 |280 |
| MA 896-18 |19 | MA 985-18 |9 | OF 810-28 |323 | OG 248-02 |280 |
| MA 896-20 |19 | MA 985-21 |9 | OF 810-29 |323 | OG 248-03 |280 |
| MA 896-25 |19 | MA 986-18 |9 | OF 850-02 |323 | OG 248-05 |280 |
| MA 897-11 |24 | MA 986-21 |9 | OF 850-03 |323 | OG 248-06 |280 |
| MA 898-11 |24 | MA 986-23 |9 | OF 850-05 |323 | OG 248-07 |280 |
| MA 900-12 |8 | MA 987-15 |9 | OF 850-06 |323 | OG 248-08 |280 |
| MA 901-12 |8 | MA 987-18 |9 | OF 850-08 |323 | OG 248-09 |280 |
| MA 902-12 |8 | MA 987-21 |9 | OF 850-09 |323 | OG 250-01 |280 |
| MA 903-12 |9 | MA 987-23 |9 | OF 850-10 |323 | OG 250-02 |280 |
| MA 904-12 |9 | OF 200-27 |334 | OF 850-12 |323 | OG 250-03 |280 |
| MA 906-12 |9 | OF 204-37 |334 | OF 850-15 |323 | OG 251-01 |280 |
| MA 910-02 |8 | OF 205-47 |331 | OF 880-11 |322 | OG 251-02 |280 |
| MA 912-09 |8 | OF 206-14 |328 | OF 880-17 |322 | OG 251-03 |280 |
| MA 929-01 |8 | OF 207-14 |329 | OF 900-16 |320 | OG 251-04 |280 |
| MA 929-02 |8 | OF 208-22 |329 | OF 910-04 |320 | OG 252-01 |281 |
| MA 947-01 |9 | OF 213-18 |329 | OF 910-16 |320 | OG 252-02 |281 |
| MA 947-02 |9 | OF 214-17 |330 | OF 910-26 |320 | OG 252-03 |281 |
| MA 947-04 |9 | OF 215-23 |330 | OF 940-30 |318 | OG 253-01 |281 |
| MA 947-05 |9 | OF 216-23 |330 | OF 940-40 |318 | OG 253-02 |281 |
| MA 947-07 |9 | OF 240-15 |415 | OF 940-50 |318 | OG 253-03 |281 |
| MA 947-08 |9 | OF 241-00 |415 | OF 945-33 |318 | OG 253-04 |281 |
| MA 975-01 |10 | OF 400-14 |326 | OG 100-24 |259 | OG 254-01 |281 |
| MA 975-02 |10 | OF 450-17 |326 | OG 110-04 |262 | OG 254-02 |281 |

| Catalog Code | Page | Catalog Code | Page | Catalog Code | Page | Catalog Code | Page |
|--------------|----------|--------------|----------|--------------|----------|--------------|----------|
| OG 254-03 |281 | OG 302-03 |305 | OM 320-01 |307 | OM 420-22 |291 |
| OG 254-04 |281 | OG 350-01 |289 | OM 320-02 |307 | OM 421-19 |291 |
| OG 254-05 |281 | OG 350-02 |289 | OM 321-01 |308 | OM 422-24 |291 |
| OG 255-01 |281 | OG 350-03 |289 | OM 321-02 |308 | PO 100-10 |108 |
| OG 255-02 |281 | OG 350-04 |289 | OM 322-18 |308 | PO 101-10 |108 |
| OG 255-03 |281 | OG 351-01 |289 | OM 329-19 |308 | PO 102-10 |108 |
| OG 255-04 |281 | OG 351-02 |289 | OM 330-20 |308 | PO 103-10 |108 |
| OG 255-05 |281 | OG 351-03 |289 | OM 331-21 |308 | PO 104-13 |110 |
| OG 257-02 |282 | OG 354-01 |277 | OM 333-16 |307 | PO 104-14 |110 |
| OG 257-03 |282 | OG 354-02 |277 | OM 333-17 |307 | PO 105-14 |109 |
| OG 257-04 |282 | OG 354-03 |277 | OM 335-18 |309 | PO 106-14 |109 |
| OG 257-05 |282 | OG 355-01 |277 | OM 336-18 |309 | PO 108-15 |110 |
| OG 259-01 |282 | OG 355-02 |277 | OM 337-19 |310 | PO 109-15 |110 |
| OG 259-02 |282 | OG 355-03 |277 | OM 338-15 |309 | PO 110-15 |109 |
| OG 259-03 |282 | OG 423-01 |288 | OM 338-24 |310 | PO 111-15 |109 |
| OG 259-04 |282 | OG 423-02 |288 | OM 339-15 |309 | PO 115-18 |110 |
| OG 260-01 |283 | OG 424-01 |288 | OM 340-01 |308 | PO 116-18 |110 |
| OG 261-01 |283 | OG 424-02 |288 | OM 340-02 |308 | PO 117-18 |109 |
| OG 262-01 |283 | OG 451-01 |287 | OM 340-17 |309 | PO 118-18 |109 |
| OG 276-05 |286 | OG 451-02 |287 | OM 340-20 |310 | PO 119-09 |112 |
| OG 276-10 |286 | OG 451-03 |287 | OM 350-23 |312 | PO 120-09 |112 |
| OG 276-15 |286 | OG 451-04 |287 | OM 351-23 |312 | PO 121-09 |112 |
| OG 276-20 |286 | OG 451-05 |287 | OM 351-25 |312 | PO 122-09 |112 |
| OG 276-25 |286 | OG 706-21 |283 | OM 352-24 |311 | PO 123-14 |112 |
| OG 277-02 |284 | OM 152-02 |299 | OM 354-24 |311 | PO 127-14 |112 |
| OG 279-17 |284 | OM 200-37 |299 | OM 355-24 |313 | PO 128-14 |112 |
| OG 280-14 |285 | OM 205-15 |302 | OM 357-22 |313 | PO 131-16 |112 |
| OG 281-14 |285 | OM 205-24 |302 | OM 358-22 |313 | PO 131-18 |112 |
| OG 282-16 |285 | OM 205-32 |302 | OM 358-27 |313 | PO 132-16 |112 |
| OG 283-16 |285 | OM 230-13 |300 | OM 360-14 |314 | PO 132-18 |112 |
| OG 284-18 |285 | OM 230-15 |300 | OM 360-17 |314 | PO 160-20 |124 |
| OG 286-18 |285 | OM 230-17 |300 | OM 360-20 |314 | PO 161-20 |124 |
| OG 286-19 |285 | OM 230-20 |300 | OM 360-22 |314 | PO 162-20 |124 |
| OG 288-02 |284 | OM 231-14 |301 | OM 361-14 |314 | PO 163-20 |124 |
| OG 291-10 |286 | OM 231-17 |301 | OM 361-17 |314 | PO 164-21 |124 |
| OG 291-13 |286 | OM 231-23 |301 | OM 361-20 |314 | PO 164-27 |124 |
| OG 291-19 |286 | OM 310-17 |306 | OM 361-22 |314 | PO 165-21 |124 |
| OG 300-14 |303 | OM 310-20 |306 | OM 362-15 |315 | PO 165-27 |124 |
| OG 300-19 |303 | OM 311-21 |306 | OM 362-19 |315 | PO 166-20 |125 |
| OG 300-24 |303 | OM 312-17 |306 | OM 363-15 |315 | PO 167-20 |125 |
| OG 300-26 |303 | OM 313-00 |306 | OM 363-19 |315 | PO 168-20 |125 |
| OG 300-28 |303 | OM 318-01 |307 | OM 365-24 |316 | PO 169-20 |125 |
| OG 301-17 |304 | OM 318-02 |307 | OM 366-28 |316 | PO 170-21 |125 |
| OG 302-01 |305 | OM 319-14 |307 | OM 367-28 |316 | PO 170-27 |125 |
| OG 302-02 |305 | OM 319-15 |307 | OM 369-25 |317 | PO 171-21 |125 |



| Catalog Code | Page | Catalog Code | Page | Catalog Code | Page | Catalog Code | Page |
|--------------|----------|--------------|----------|--------------|----------|--------------|----------|
| PO 171-27 |125 | PO 903-20 |121 | PO 965-02 |110 | SO 202-13 |129 |
| PO 210-12 |113 | PO 903-23 |121 | PO 966-01 |109 | SO 202-14 |129 |
| PO 211-12 |113 | PO 903-26 |121 | PO 966-02 |109 | SO 202-16 |129 |
| PO 214-13 |113 | PO 910-12 |118 | PO 967-01 |110 | SO 203-14 |129 |
| PO 216-13 |113 | PO 911-12 |118 | PO 967-02 |110 | SO 203-16 |129 |
| PO 218-12 |126 | PO 912-13 |119 | PO 968-01 |109 | SO 203-18 |129 |
| PO 219-15 |114 | PO 914-13 |118 | PO 968-02 |109 | SO 203-20 |129 |
| PO 220-15 |114 | PO 915-13 |118 | PO 969-01 |110 | SO 204-10 |129 |
| PO 230-14 |115 | PO 916-13 |118 | PO 969-02 |110 | SO 205-13 |128 |
| PO 230-16 |115 | PO 916-14 |119 | PO 970-01 |109 | SO 205-14 |128 |
| PO 230-18 |115 | PO 919-15 |119 | PO 970-02 |109 | SO 205-16 |128 |
| PO 230-20 |115 | PO 920-18 |119 | PO 970-03 |109 | SO 206-14 |128 |
| PO 230-24 |115 | PO 920-20 |119 | PO 970-04 |109 | SO 207-13 |128 |
| PO 230-26 |115 | PO 920-23 |119 | PO 970-23 |122 | SO 207-14 |128 |
| PO 230-30 |115 | PO 921-18 |111 | PO 981-27 |122 | SO 207-16 |128 |
| PO 231-16 |115 | PO 921-23 |111 | RG 510-20 |234 | SO 208-16 |128 |
| PO 231-18 |115 | PO 924-14 |123 | RG 510-28 |234 | SO 209-20 |128 |
| PO 231-20 |115 | PO 924-17 |123 | RG 550-01 |260 | SO 212-12 |130 |
| PO 232-21 |116 | PO 924-19 |123 | RG 550-02 |260 | SO 212-14 |130 |
| PO 233-23 |116 | PO 926-14 |123 | RG 551-01 |261 | SO 212-15 |130 |
| PO 234-27 |116 | PO 926-17 |123 | RG 551-02 |261 | SO 212-16 |130 |
| PO 239-14 |117 | PO 926-20 |123 | RG 605-00 |319 | SO 601-33 |253 |
| PO 241-14 |117 | PO 945-13 |324 | RG 605-01 |319 | SO 602-33 |253 |
| PO 241-17 |117 | PO 945-18 |324 | RG 605-02 |319 | SP 101-24 |252 |
| PO 900-16 |120 | PO 946-02 |324 | RG 610-13 |319 | SP 103-21 |225 |
| PO 900-18 |120 | PO 947-18 |324 | RG 610-14 |319 | SP 104-22 |225 |
| PO 900-20 |120 | PO 948-01 |325 | RG 610-16 |319 | SP 106-14 |226 |
| PO 900-24 |120 | PO 948-02 |325 | RG 610-22 |319 | SP 107-21 |226 |
| PO 900-26 |120 | PO 948-03 |325 | RG 611-14 |319 | SP 107-27 |226 |
| PO 900-30 |120 | PO 949-17 |334 | RG 612-02 |319 | SP 110-16 |225 |
| PO 901-15 |120 | PO 950-14 |112 | SO 100-15 |235 | SP 150-15 |258 |
| PO 901-18 |120 | PO 951-14 |112 | SO 110-15 |235 | SP 150-19 |258 |
| PO 901-20 |120 | PO 952-14 |112 | SO 200-11 |129 | SP 200-08 |236 |
| PO 901-23 |120 | PO 953-14 |112 | SO 200-13 |129 | SP 200-09 |236 |
| PO 901-26 |120 | PO 954-18 |112 | SO 200-14 |129 | SP 200-10 |236 |
| PO 901-31 |120 | PO 955-18 |112 | SO 200-16 |129 | SP 200-11 |236 |
| PO 902-13 |121 | PO 956-18 |112 | SO 200-18 |129 | SP 200-12 |236 |
| PO 902-15 |121 | PO 957-18 |112 | SO 200-20 |129 | SP 200-13 |236 |
| PO 902-18 |121 | PO 958-01 |112 | SO 201-11 |129 | SP 200-14 |236 |
| PO 902-20 |121 | PO 958-02 |112 | SO 201-13 |129 | SP 200-15 |236 |
| PO 902-23 |121 | PO 959-01 |112 | SO 201-14 |129 | SP 200-16 |236 |
| PO 902-26 |121 | PO 959-02 |112 | SO 201-16 |129 | SP 200-17 |236 |
| PO 903-13 |121 | PO 959-03 |112 | SO 201-18 |129 | SP 200-18 |236 |
| PO 903-15 |121 | PO 959-04 |112 | SO 201-20 |129 | SP 200-19 |236 |
| PO 903-18 |121 | PO 965-01 |110 | SO 201-25 |129 | SP 200-20 |236 |

| Catalog Code | Page | Catalog Code | Page | Catalog Code | Page | Catalog Code | Page |
|--------------|----------|--------------|----------|--------------|----------|--------------|----------|
| SP 200-21 |236 | SP 276-30 |245 | SP 500-05 |251 | SP 506-16 |251 |
| SP 200-22 |236 | SP 276-35 |245 | SP 500-06 |251 | SP 506-18 |251 |
| SP 200-23 |236 | SP 276-40 |245 | SP 500-07 |251 | TN 100-35 |267 |
| SP 200-24 |236 | SP 277-20 |245 | SP 500-08 |251 | TN 101-25 |254 |
| SP 200-25 |236 | SP 277-25 |245 | SP 500-09 |251 | TN 102-25 |255 |
| SP 200-26 |236 | SP 277-30 |245 | SP 500-10 |251 | TN 103-25 |254 |
| SP 200-27 |236 | SP 277-35 |245 | SP 500-11 |251 | TN 108-25 |254 |
| SP 200-28 |236 | SP 277-40 |245 | SP 500-12 |251 | TN 207-15 |255 |
| SP 200-29 |236 | SP 278-40 |245 | SP 500-13 |251 | TN 208-20 |256 |
| SP 200-30 |236 | SP 279-40 |245 | SP 500-14 |251 | TN 208-21 |256 |
| SP 210-01 |230 | SP 285-01 |240 | SP 500-15 |251 | TS 101-0103 |416 |
| SP 210-02 |230 | SP 285-02 |240 | SP 500-16 |251 | TS 101-0104 |416 |
| SP 210-03 |230 | SP 285-03 |240 | SP 500-17 |251 | TS 101-0105 |416 |
| SP 210-04 |230 | SP 286-18 |241 | SP 500-18 |251 | TS 101-0106 |416 |
| SP 210-05 |230 | SP 286-20 |241 | SP 500-19 |251 | TS 101-0107 |416 |
| SP 210-06 |230 | SP 286-27 |242 | SP 500-20 |251 | TS 101-0108 |416 |
| SP 210-07 |230 | SP 286-30 |242 | SP 500-21 |251 | TS 101-0109 |416 |
| SP 210-08 |230 | SP 286-36 |242 | SP 500-22 |251 | TS 101-0110 |416 |
| SP 210-09 |230 | SP 287-14 |241 | SP 500-23 |251 | TS 101-0113 |416 |
| SP 210-10 |230 | SP 287-16 |241 | SP 500-24 |251 | TS 101-0115 |417 |
| SP 210-11 |230 | SP 287-18 |241 | SP 500-25 |251 | TS 101-0118 |417 |
| SP 210-12 |230 | SP 287-20 |241 | SP 500-26 |251 | TS 101-0120 |417 |
| SP 210-13 |230 | SP 287-23 |242 | SP 501-01 |251 | TS 101-0125 |417 |
| SP 250-32 |238 | SP 287-26 |242 | SP 501-02 |251 | TS 200-0120 |417 |
| SP 250-40 |238 | SP 287-30 |242 | SP 501-04 |251 | UE 100-00 |211 |
| SP 255-00 |238 | SP 287-32 |242 | SP 501-05 |251 | YC 200-17 |298 |
| SP 255-25 |238 | SP 287-36 |242 | SP 501-06 |251 | YC 201-23 |297 |
| SP 255-27 |238 | SP 290-00 |249 | SP 501-07 |251 | YC 202-34 |297 |
| SP 255-30 |238 | SP 290-01 |249 | SP 501-08 |251 | YC 206-26 |296 |
| SP 256-01 |238 | SP 290-02 |249 | SP 501-09 |251 | YC 207-28 |296 |
| SP 256-02 |238 | SP 290-03 |249 | SP 501-10 |251 | YC 208-24 |295 |
| SP 256-03 |238 | SP 290-35 |248 | SP 501-11 |251 | YC 208-25 |295 |
| SP 258-32 |239 | SP 291-17 |243 | SP 501-12 |251 | YC 209-26 |296 |
| SP 258-36 |239 | SP 291-20 |243 | SP 501-13 |251 | YC 211-22 |294 |
| SP 258-37 |239 | SP 295-01 |243 | SP 501-14 |251 | YC 212-24 |295 |
| SP 260-33 |239 | SP 300-28 |248 | SP 501-15 |251 | YC 213-24 |294 |
| SP 260-35 |239 | SP 302-75 |247 | SP 501-16 |251 | YC 214-25 |294 |
| SP 260-43 |239 | SP 400-20 |248 | SP 501-17 |251 | YC 215-26 |298 |
| SP 265-20 |239 | SP 400-30 |248 | SP 506-02 |251 | YC 215-28 |298 |
| SP 265-30 |239 | SP 400-36 |248 | SP 506-04 |251 | YC 216-15 |293 |
| SP 265-33 |239 | SP 450-13 |234 | SP 506-06 |251 | YC 218-15 |293 |
| SP 270-22 |239 | SP 500-01 |251 | SP 506-08 |251 | YC 219-15 |293 |
| SP 270-25 |239 | SP 500-02 |251 | SP 506-10 |251 | YC 220-15 |293 |
| SP 276-20 |245 | SP 500-03 |251 | SP 506-12 |251 | YC 221-16 |293 |
| SP 276-25 |245 | SP 500-04 |251 | SP 506-14 |251 | | |

+90 242 311 1 654

info@idolcerrahi.com

İdol Hastane Ürünleri San. Tic. A.Ş.

Altınova Sinan mah. 39/1 sk. No:75 Posta kodu:07170

ANTALYA / TÜRKİYE

All rights reserved CTLG.01-General

CE
2696

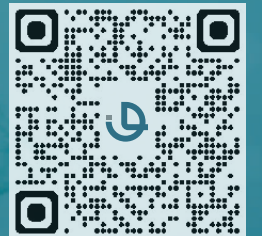

idolcerrahi.com