



# idol

Surgical Instruments

Neurosurgery







We shape steel for health



## HAKKIMIZDA

2005 yılındaki kuruluşundan bu yana sağlık sektörünün gelişen ve değişen ihtiyaçlarını yakından izleyen İdol, cerrahi enstrümanlar alanında güvenilir bir çözüm ortağı olarak faaliyet göstermektedir. Tüm cerrahi branşlara yönelik enstrümanlar üreten İdol, klinik gereksinimleri doğru analiz ederek kullanıcı odaklı ve etkin çözümler sunar.

Faaliyetlerini EN ISO 13485 kalite yönetim sistemi doğrultusunda ve Avrupa Tıbbi Cihaz Regülasyonu 2017/745 (MDR) gerekliliklerine uygun olarak sürdüren İdol, 2023 yılında MDR uyumlu CE sertifikasını almaya hak kazanmıştır. Titiz kalite anlayışını teknik uzmanlıkla birleştiren İdol, cerrahi uygulamalarda güven veren, yüksek standartlara sahip ürünler geliştirmeye kararlılıkla devam etmektedir.

## ABOUT US

Since its establishment in 2005, İdol has closely followed the evolving needs of the healthcare sector and has operated as a reliable solution partner in the field of surgical instruments. Producing instruments for all surgical branches, İdol accurately analyzes clinical requirements and offers user-focused and effective solutions.

Carrying out its activities in line with the EN ISO 13485 quality management system and in compliance with the requirements of the European Medical Device Regulation 2017/745 (MDR), İdol obtained its MDR-compliant CE certification in 2023. Combining meticulous quality principles with technical expertise, İdol continues to develop high-standard products that inspire confidence in surgical practice.



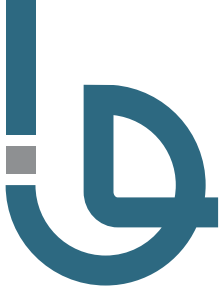

refers to products that can be used integrated



defines that the jaws of instruments such as forceps and clamps have 1x2 DeBakey features

### delicate

identifies delicate and slim structured instruments



defines that the jaws of instruments such as forceps and clamps have 2x3 DeBakey features

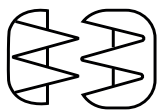

indicates the number of teeth on the end of instruments such as forceps and clamps



defines that the jaws of instruments such as forceps and clamps have "V" shaped Baby DeBakey features

### Atraumatic

defines that the jaw/tip structure of the instruments is trauma-free

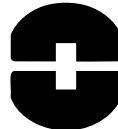

defines that the jaws of instruments such as forceps and clamps have Cooley type features

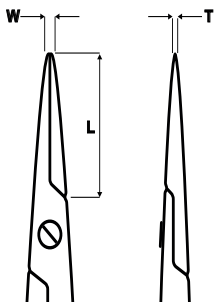

The dimensions of the micro needle holders are indicated as follows:

$$\text{Length} \times \text{Thickness} \times \text{Width} = L \times T \times W$$



Indicates the size of the cutting edge of the scissors with the number written near



indicates what size of suture material the needle holder is recommended for



defines that the working ends/ jaws of the instrument is tungsten carbide particle sprayed



Smooth insert (recommended for suture material 12-0 and smaller)



defines that the working ends/ jaws of the instrument is tungsten carbide insert



0,3 mm pitch of serration insert (recommended for suture material 9-0 and smaller)

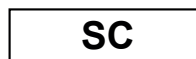

defines that the ends of the scissors is serrated edge/ knife edge



0,4 mm pitch of serration insert (recommended for suture material 6-0 and smaller)



defines that the ends of the scissors is tungsten carbide and serrated edge/knife edge



0,5 mm pitch of serration insert (recommended for suture material 4-0 and smaller)



defines that the ends of the scissors is tungsten carbide and serrated edge/knife edge, black coated

The blade dimensions of the retractors are specified as follows:

a X b : depth X width

Depth is written as the first number and width as the second number

Example: 14 X 25 mm

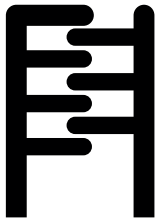
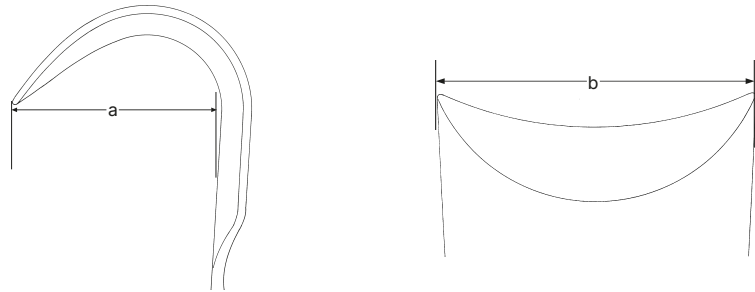
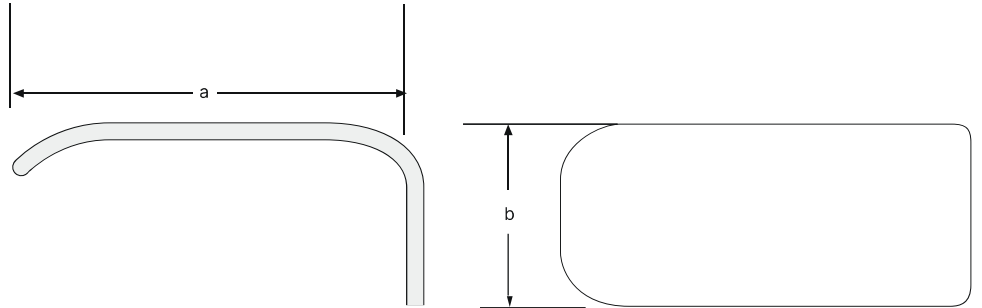

Specifies the number of prongs on the blades of spreaders

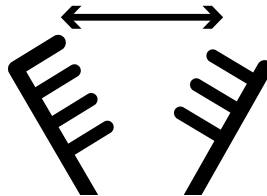

Indicates the opening width between the spreader blades

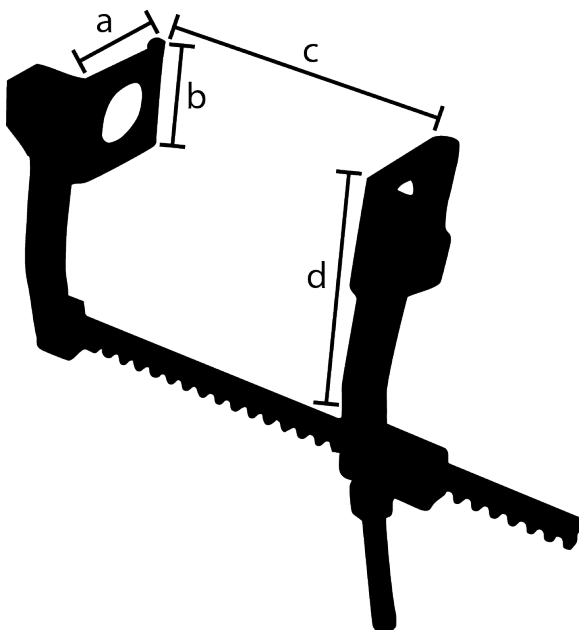

The dimensions of the retractors are specified as follows:

- a = Blade depth
- b = Blade width
- c = Spreading width
- d = Arm length



## Table of Content

---



Scalpel Handles



Scissors



Forceps



Sponge and Dressing Clamps



Clamps



Needle Holders and Suture Instruments



Spreading Instruments



Cardio Thoracic Retractors



Bone and Traumatology Instruments



Suction Tubes



Other Cardio Thoracic and Vascular Instruments

# Scalpel Handles

Scalpel Handles for Blades Fig.10-17

Scalpel Handles for Blades Fig.18-36

Scalpel Handles for Micro Scalpel Blades



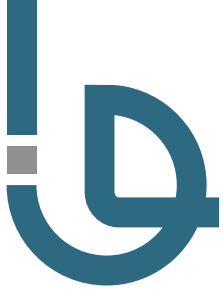

## Scalpel Handles

Scalpel Handles for Blades Fig.10-17 and Fig.18-36



Fig.10 - 17

1/2 No.3

**BS 201-03**

12 cm / 4 6/8"



Fig.18 - 36

1/2 No.4

**BS 201-04**

13,5 cm / 5 3/8"



Fig.10 - 17



Fig.10 - 17

1/2 No 3L

**BS 202-13**

21,5 cm / 8 4/8"



Fig.18 - 36

1/2 No. 4L

**BS 203-14**

21 cm / 8 2/8"

1/1 No. 7

**BS 210-07**

16 cm / 6 2/8"



BS 242-01  
13,5 cm / 5 3/8"



BS 242-02  
15,5 cm / 6"



BS 242-03  
18 cm / 7"



BS 242-04  
20 cm / 8"



1/2  
BS 243-21  
21 cm / 8 2/8"



1/2  
BS 244-25  
25 cm / 10"



~  
e  
e  
B  
R



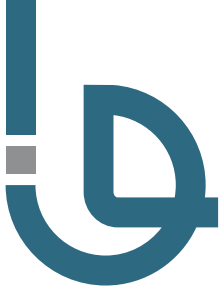

# Scissors

Micro Scissors



1/2  
Vannas  
16 cm / 6 2/8"

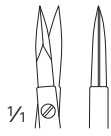

MA 971-02

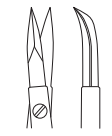

MA 972-02



1/2  
Vannas  
12 cm / 4 5/8"



MA 971-01

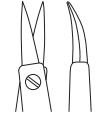

MA 972-01

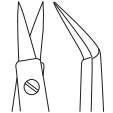

MA 973-01

angled down



1/2

15 cm / 5 7/8"

18 cm / 7 1/8"



MA 969-02

MA 969-03



MA 970-02

MA 970-03

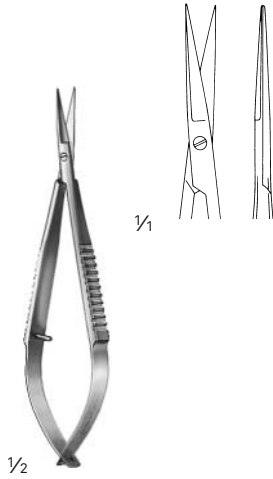

**MA 910-02**  
10 cm / 3 7/8"

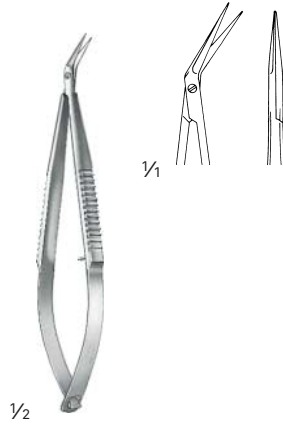

**MA 912-09**  
9,5 cm / 3 6/8"



Biemer  
**MA 974-01**  
13 cm / 5 1/8"  
Micro scissors for veins



12 cm / 4 6/8"

sharp/sharp

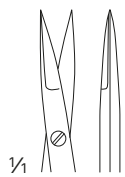

**MA 900-12**

sharp/sharp



**MA 901-12**

blunt/blunt



**MA 902-12**

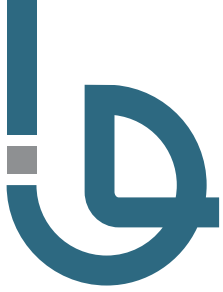

**Scissors**  
Micro Scissors



1/2



1/1

sharp/sharp



sharp/sharp



blunt/blunt



sharp/sharp  
one serrated



sharp/sharp  
one serrated

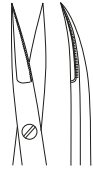

12 cm / 4 3/4"

**MA 903-12**

**MA 904-12**

**MA 906-12**

**MA 947-01**

**MA 947-04**

15 cm / 5 7/8"

**MA 984-15**

**MA 985-15**

**MA 947-07**

**MA 947-02**

**MA 947-05**

18 cm / 7 1/8"

**MA 984-18**

**MA 985-18**

**MA 947-08**

21 cm / 8"

**MA 984-21**

**MA 985-21**



1/2

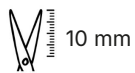

1/1

blunt/blunt



sharp/sharp  
one serrated



15 cm / 5 7/8"

**MA 986-15**

**MA 987-15**

18 cm / 7 1/8"

**MA 986-18**

**MA 987-18**

21 cm / 8"

**MA 986-21**

**MA 987-21**

23 cm / 9 1/16"

**MA 986-23**

**MA 987-23**

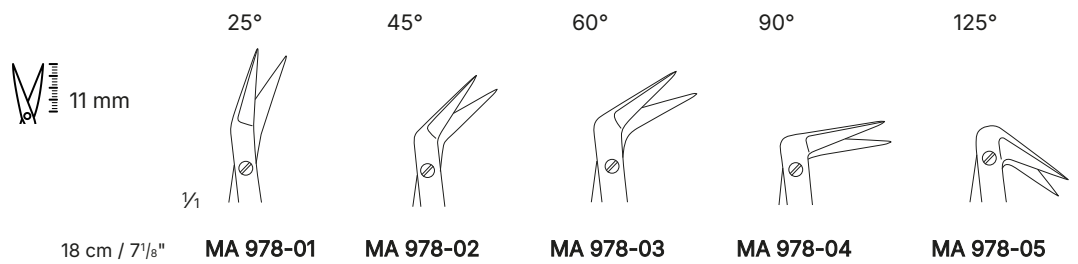
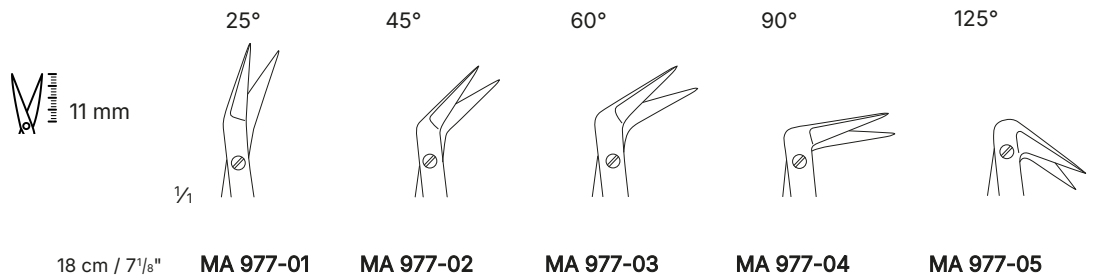
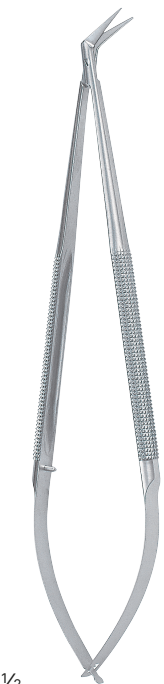
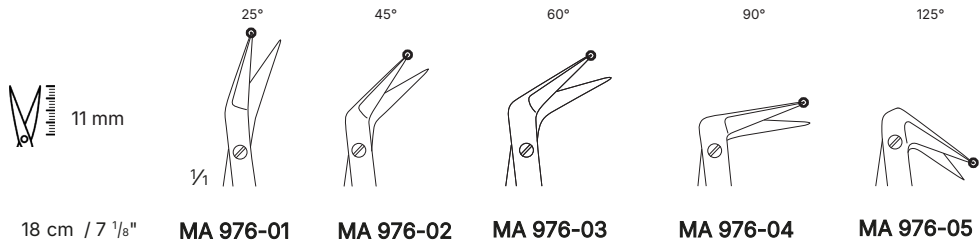
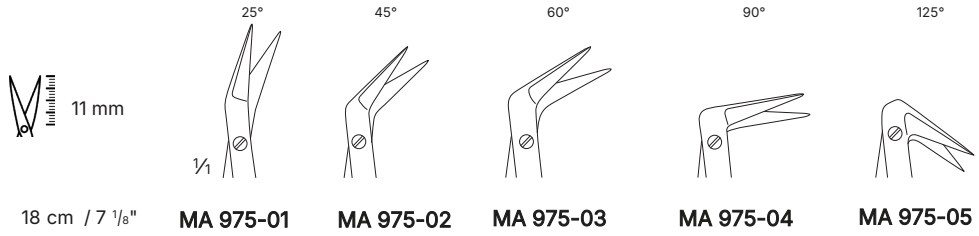



## Scissors

Micro Scissors



22 cm / 8 <sup>5</sup>/<sub>8</sub>"



MA 982-01



MA 982-02



Yasargil

16,5 cm / 6 <sup>4</sup>/<sub>8</sub>"  
20 cm / 7 <sup>7</sup>/<sub>8</sub>"



**MA 979-01**  
**MA 980-01**



**MA 979-02**  
**MA 980-02**



**MA 980-03**



Yasargil

22,5 cm / 8 <sup>7</sup>/<sub>8</sub>"



**MA 981-01**

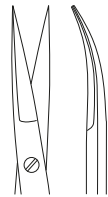

**MA 981-02**

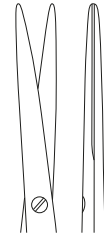

**MA 981-03**

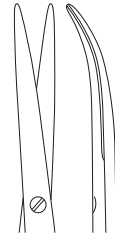

**MA 981-04**

Vannas  
22,5 cm / 8 <sup>7</sup>/<sub>8</sub>"

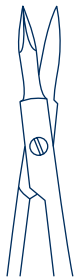

**MA 981-05**



**MA 981-06**

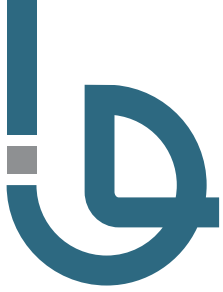

## Scissors

### Operating Scissors

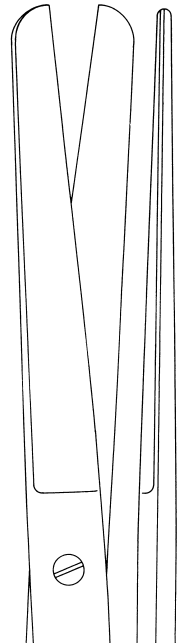
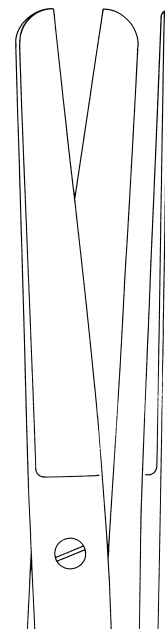
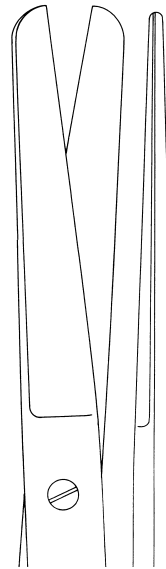
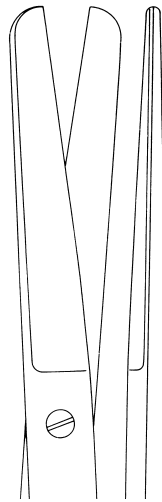
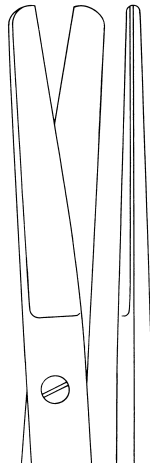
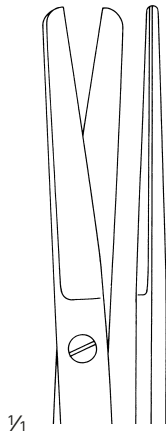

11,5 cm / 4 1/2"

13 cm / 5 1/8"

14,5 cm / 5 9/16"

16,5 cm / 6 4/8"

18,5 cm / 7 2/8"

20,5 cm / 8 1/8"

**Regular**

**MA 100-11**

**MA 100-13**

**MA 100-14**

**MA 100-16**

**MA 100-18**

**MA 100-20**



**MA 850-14**

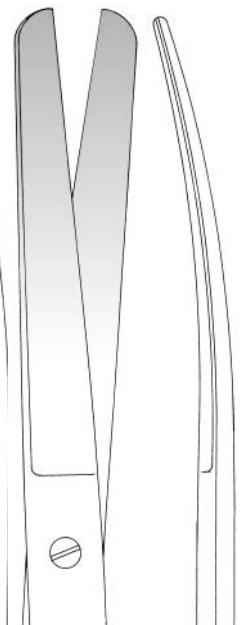
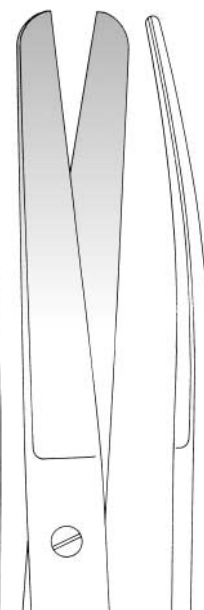
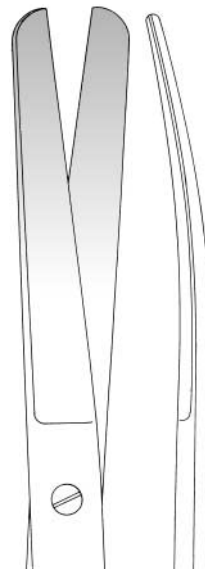
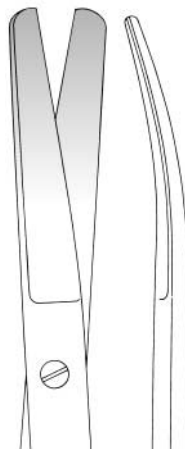
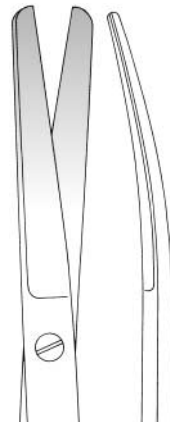
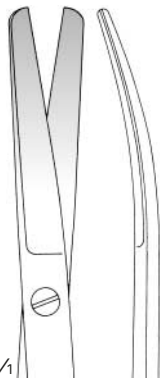

11,5 cm / 4 1/2"

13 cm / 5 1/8"

14,5 cm / 5 9/16"

16,5 cm / 6 4/8"

18,5 cm / 7 2/8"

20,5 cm / 8 1/8"

**Regular**

**MA 101-11**

**MA 101-13**

**MA 101-14**

**MA 101-16**

**MA 101-18**

**MA 101-20**



**MA 851-14**



1/2

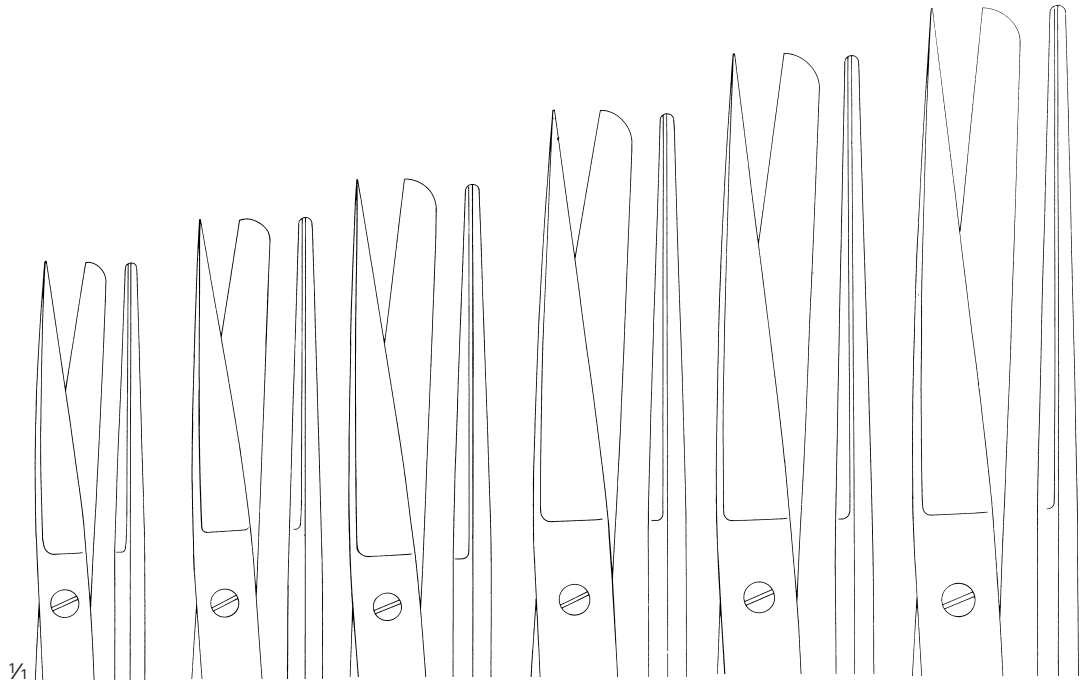

1/4

11,5 cm / 4 1/2"

13 cm / 5 1/8"

14,5 cm / 5 9/16"

16,5 cm / 6 4/8"

18,5 cm / 7 2/8"

20,5 cm / 8 1/8"

**Regular**



**MA 102-11**

**MA 102-13**

**MA 102-14**

**MA 102-16**

**MA 102-18**

**MA 102-20**

**MA 852-14**



1/2

1/4

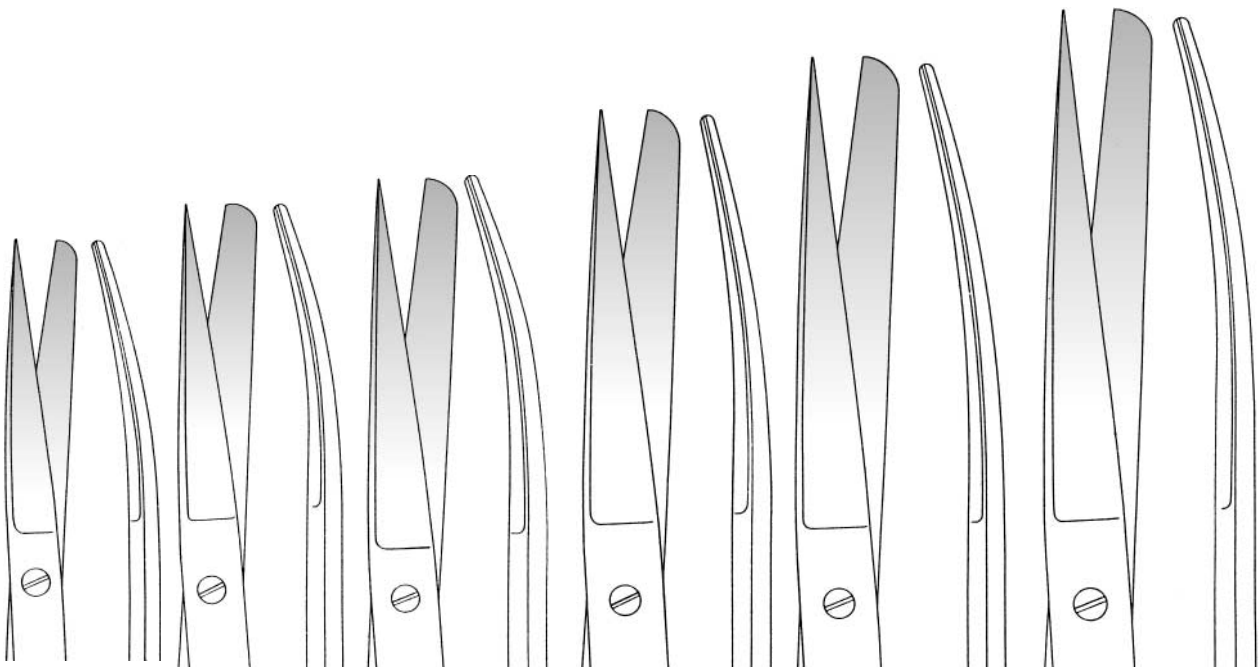

11,5 cm / 4 1/2"

13 cm / 5 1/8"

14,5 cm / 5 9/16"

16,5 cm / 6 4/8"

18,5 cm / 7 2/8"

20,5 cm / 8 1/8"

**Regular**



**MA 103-11**

**MA 103-13**

**MA 103-14**

**MA 103-16**

**MA 103-18**

**MA 103-20**

**MA 853-14**

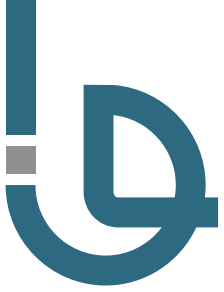

# Scissors

Operating Scissors



1/2

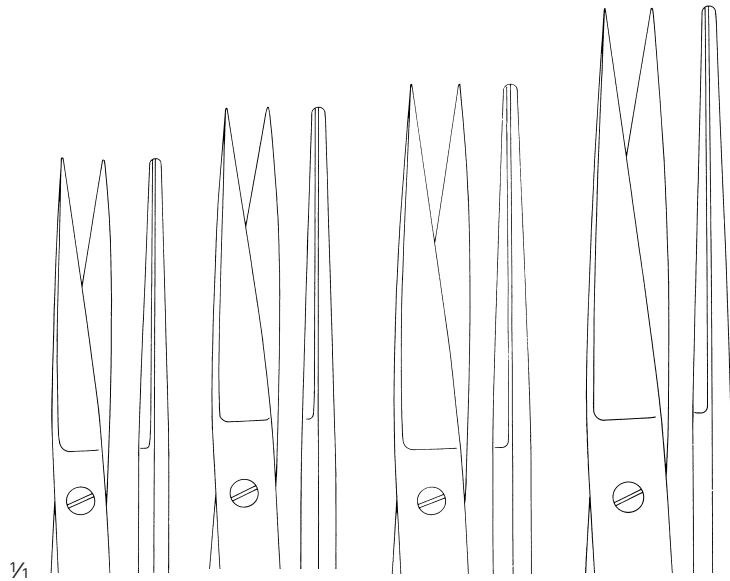

1/4

11,5 cm / 4 1/2"

13 cm / 5 1/8"

14,5 cm / 5 9/16"

16,5 cm / 6 4/8"

Regular

MA 104-11

MA 104-13

MA 104-14

MA 104-16



MA 854-14



1/2

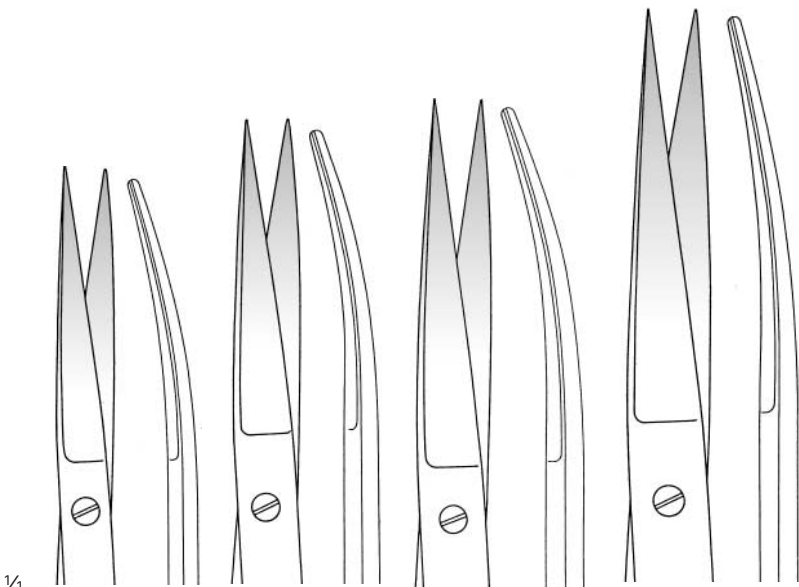

1/4

11,5 cm / 4 1/2"

13 cm / 5 1/8"

14,5 cm / 5 9/16"

16,5 cm / 6 4/8"

Regular

MA 105-11

MA 105-13

MA 105-14

MA 105-16



MA 855-14

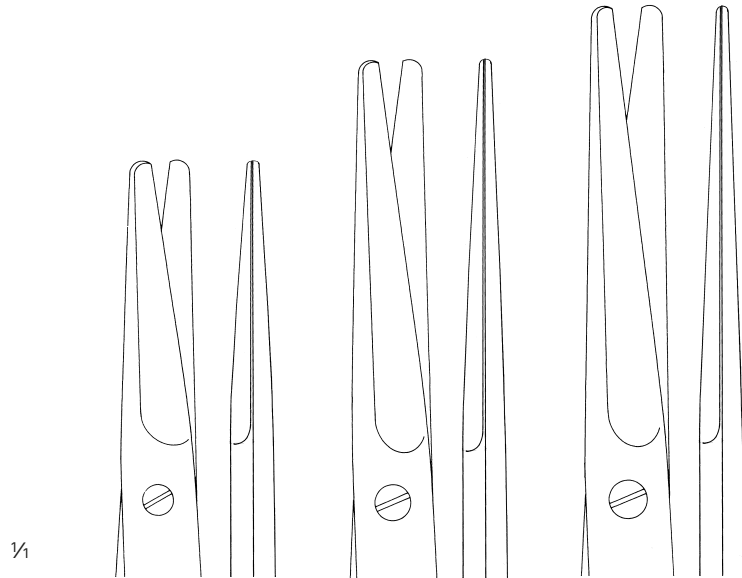

**Regular**  
**TC**

14,5 cm / 5 6/8"

**MA 125-14**

**MA 856-14**

17 cm / 6 6/8"

**MA 125-17**

**MA 856-17**

23 cm / 9"

**MA 125-23**

**MA 856-23**

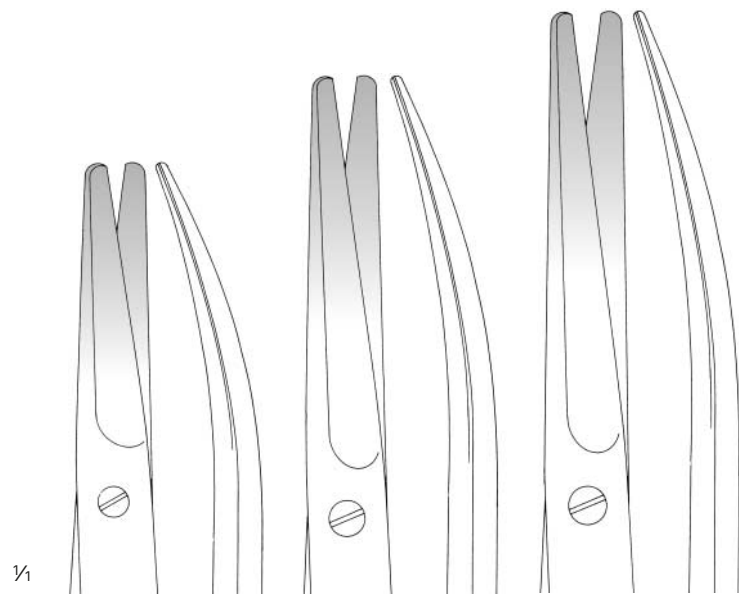

**Regular**  
**TC**

14,5 cm / 5 6/8"

**MA 126-14**

**MA 857-14**

17 cm / 6 6/8"

**MA 126-17**

**MA 857-17**

23 cm / 9"

**MA 126-23**

**MA 857-23**

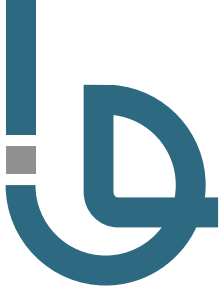

**Scissors**  
Dissecting Scissors



1/2

**Mayo-Noble**

17 cm / 6 5/8"

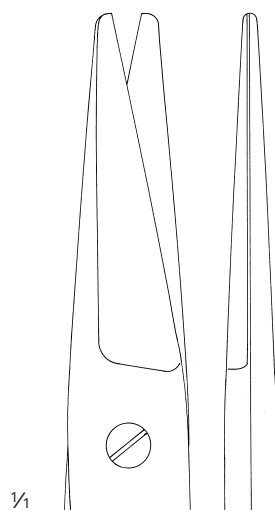

1/4

**MA 120-17**

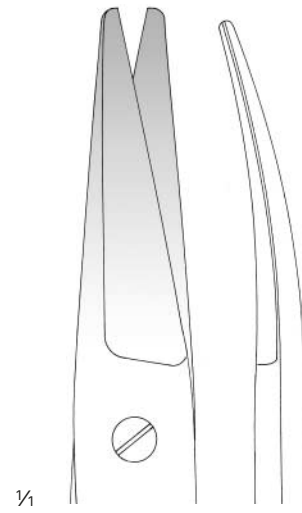

1/4

**MA 121-17**



Mayo-Stille

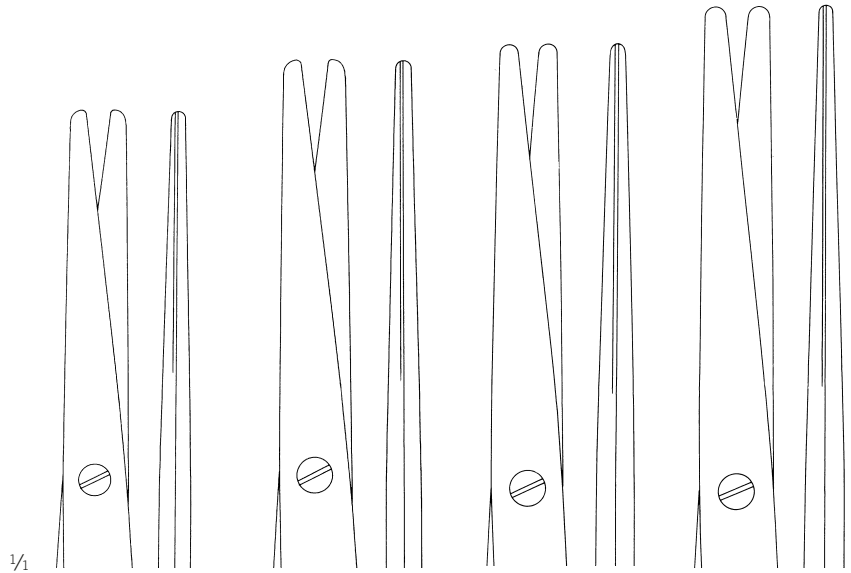

1/1

15 cm / 5 7/8"      17 cm / 6 6/8"      19,5 cm / 7 5/8"      21 cm / 8 2/8"

<b>Regular</b>	<b>MA 127-15</b>	<b>MA 127-17</b>	<b>MA 127-19</b>	<b>MA 127-21</b>
<b>TC</b>	<b>MA 859-15</b>	<b>MA 859-17</b>		



Mayo-Stille

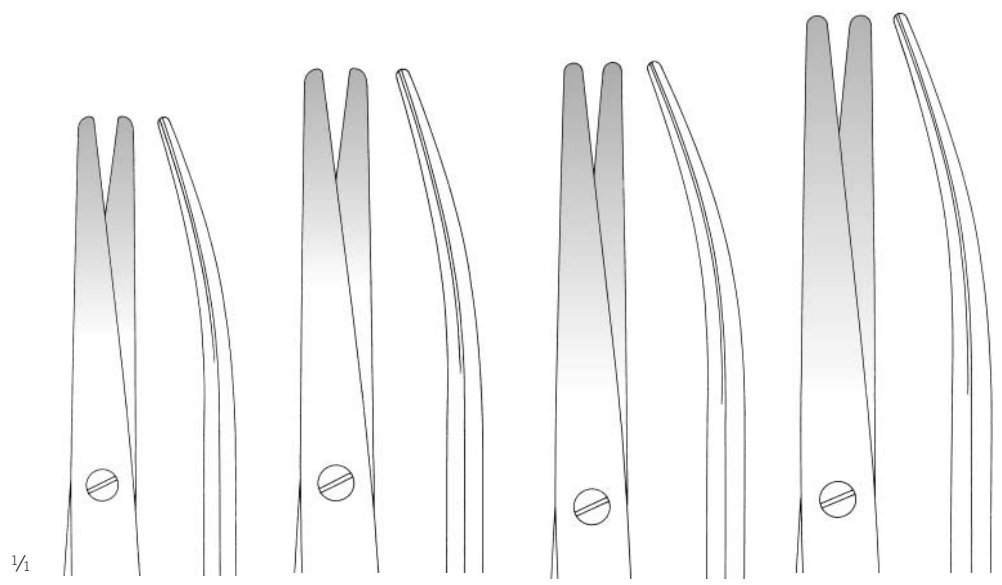

1/1

15 cm / 5 7/8"      17 cm / 6 6/8"      19,5 cm / 7 5/8"      21,5 cm / 8 4/8"

<b>Regular</b>	<b>MA 128-15</b>	<b>MA 128-17</b>	<b>MA 128-19</b>	<b>MA 128-21</b>
<b>TC</b>	<b>MA 860-15</b>	<b>MA 860-17</b>		



# Scissors

## Dissecting Scissors



1/2

**Lexer**

16 cm / 6 2/8"

1/4

**Regular**

**TC**

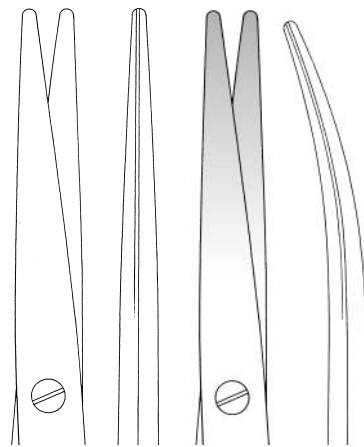

**MA 220-16**

**MA 221-16**

**MA 873-16**

**MA 874-16**



1/2

**Lexer-Baby**

10 cm / 3 7/8"

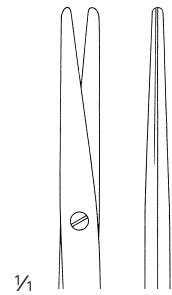

1/4

**MA 224-10**

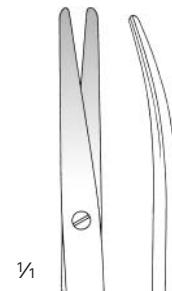

1/4

**MA 225-10**



1/2

**Metzenbaum**

1/4

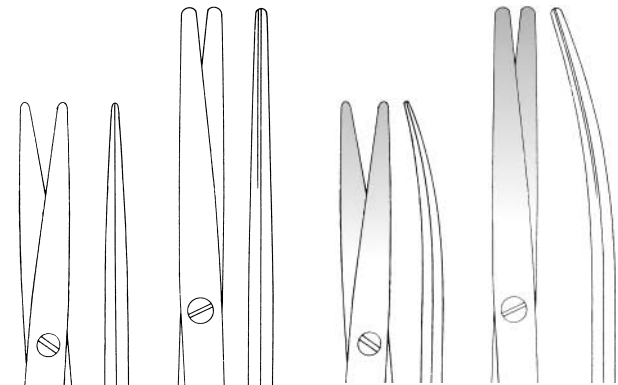

11,5 cm / 4 1/2"

14,5 cm / 5 9/16"

11,5 cm / 4 1/2"

14,5 cm / 5 9/16"

**Regular**

**TC**

**SC**

**TC/SC**

**MA 155-11**

**MA 149-14**

**MA 156-11**

**MA 150-14**

**MA 865-11**

**MA 867-14**

**MA 866-11**

**MA 868-14**

**MA 891-11**

**MA 891-14**

**MA 892-11**

**MA 892-14**

**MA 896-11**

**MA 896-14**

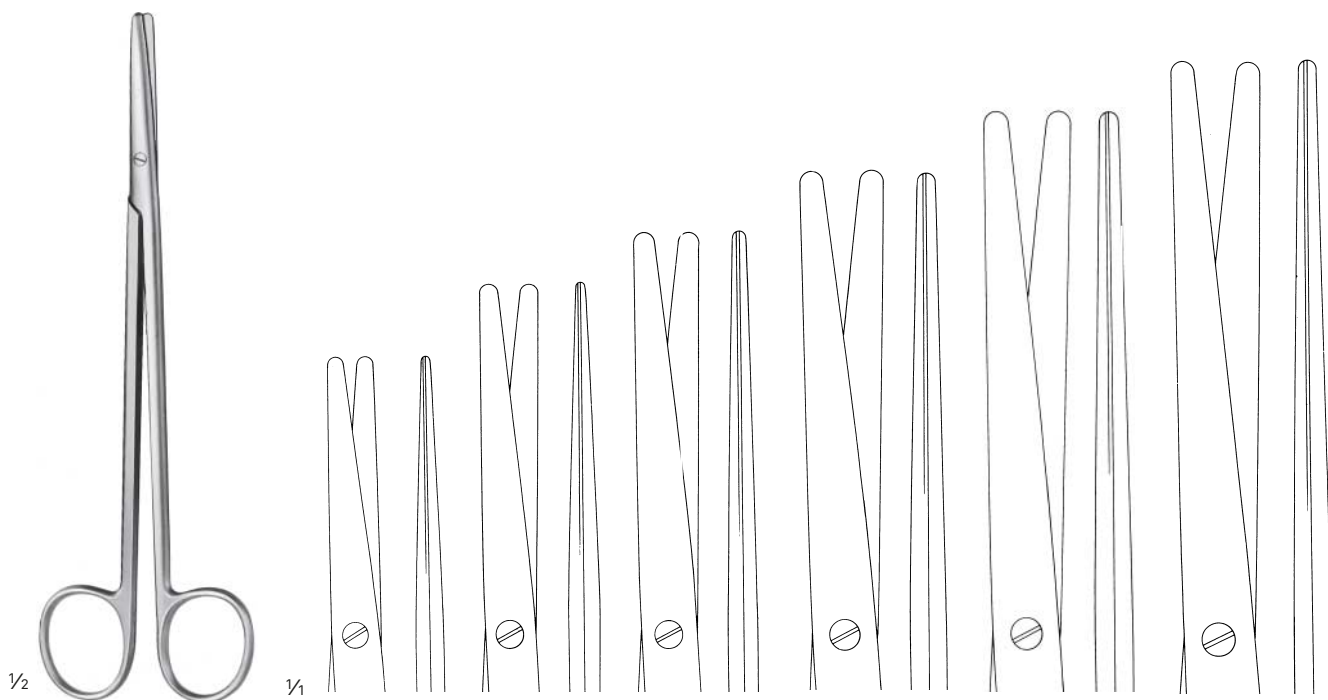

Metzenbaum

18 cm / 7 1/8"    20,5 cm / 8 1/8"    23 cm / 9"    26 cm / 10 2/8"    28,5 cm / 11 2/8"    31 cm / 12 2/8"

<b>Regular</b>	MA 200-18	MA 200-20	MA 200-23	MA 200-25	MA 200-28	MA 200-30
<b>TC</b>	MA 869-18	MA 869-20	MA 869-23	MA 869-25	MA 869-28	MA 869-30
<b>SC</b>	MA 891-18	MA 891-20	MA 891-23	MA 891-25	MA 891-28	
<b>TC/SC</b>	MA 893-18	MA 893-20	MA 893-23			

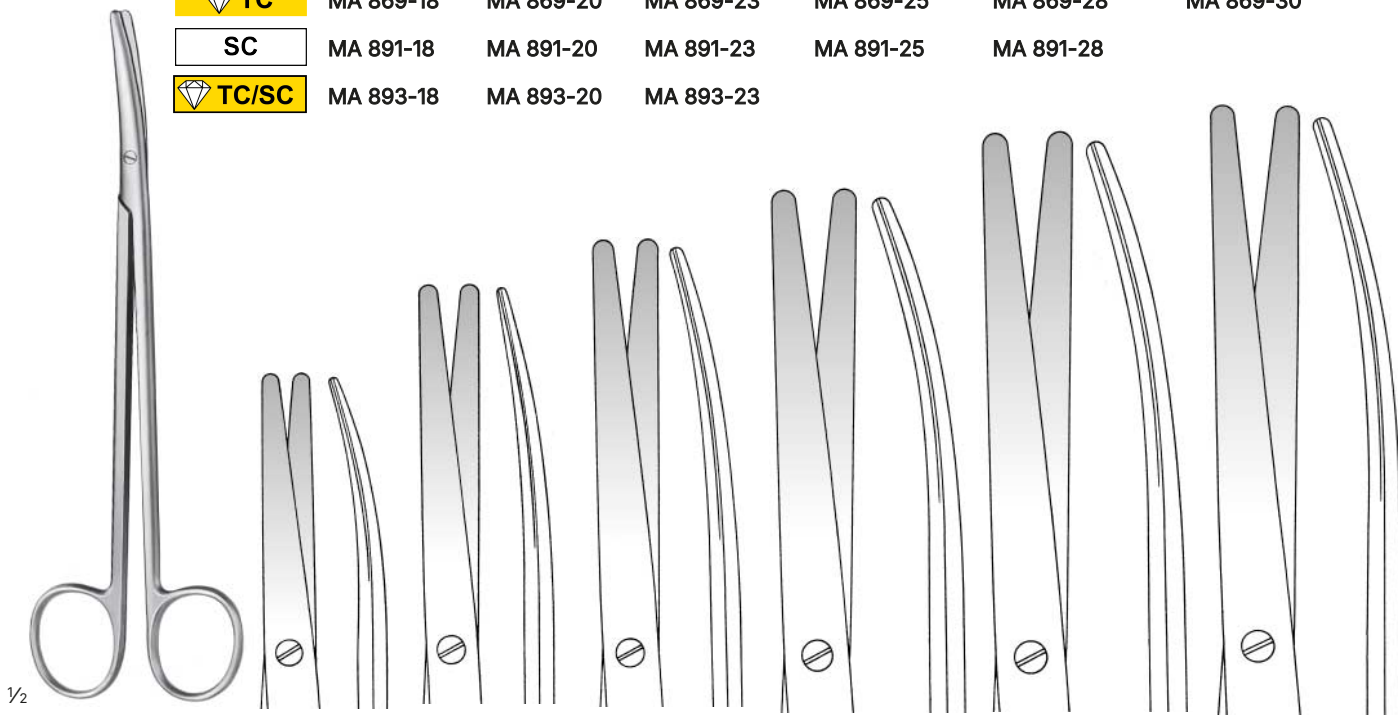

18 cm / 7 1/8"    20,5 cm / 8 1/8"    23 cm / 9"    26 cm / 10 2/8"    28,5 cm / 11 2/8"    31 cm / 12 1/8"

<b>Regular</b>	MA 201-18	MA 201-20	MA 201-23	MA 201-25	MA 201-28	MA 201-30
<b>TC</b>	MA 870-18	MA 870-20	MA 870-23	MA 870-25	MA 870-28	MA 870-30
<b>SC</b>	MA 892-18	MA 892-20	MA 892-23	MA 892-25	MA 892-28	
<b>TC/SC</b>	MA 894-18	MA 894-20	MA 894-23	MA 894-25		
<b>BlackLine</b>	MA 896-18	MA 896-20	MA 896-23	MA 896-25		



## Scissors

Delicate Dissecting Scissors



1/2

Metzenbaum

delicate

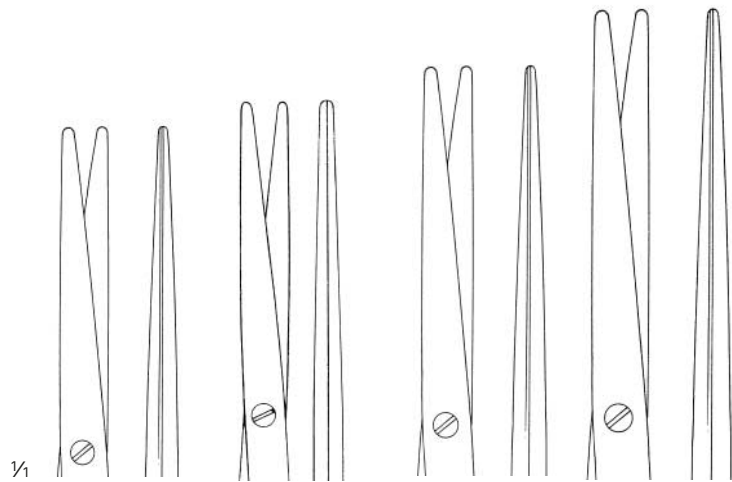

1/1

14,5 cm / 5 9/16"

18 cm / 7 1/8"

20,5 cm / 8 1/8"

23 cm / 9"

**Regular**

MA 210-14

MA 214-18

MA 214-20

MA 214-23



**TC**

MA 875-14

MA 879-18



1/2

Metzenbaum

delicate

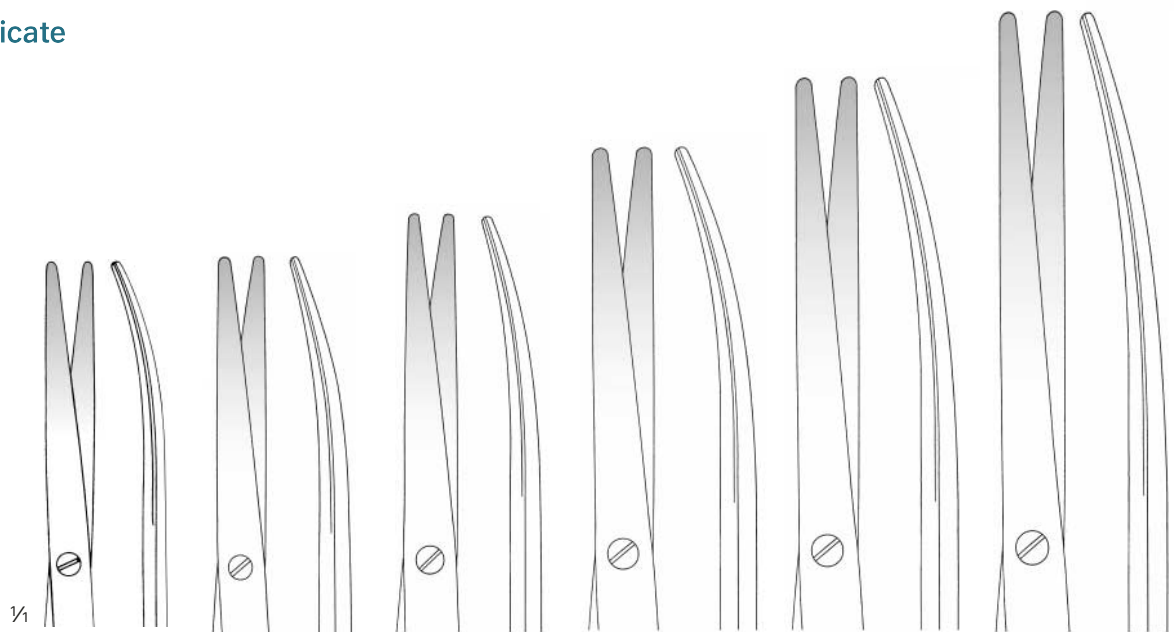

1/1

14,5 cm / 5 9/16"

18 cm / 7 1/8"

20,5 cm / 8 1/8"

23 cm / 9"

26 cm / 10 3/8"

28,5 cm / 11 3/8"

**Regular**

MA 211-14

MA 215-18

MA 215-20

MA 215-23



**TC**

MA 876-14

MA 880-18

MA 880-20

MA 880-23

MA 880-25

MA 880-28



delicate

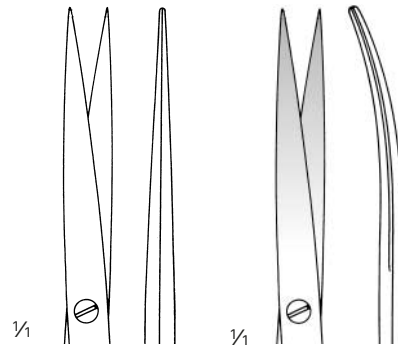

14,5 cm / 5 9/16"

Regular

MA 212-14



MA 877-14

14,5 cm / 5 9/16"

MA 213-14

MA 878-14



delicate



17,5 cm / 6 7/8"

Regular

MA 255-17



MA 883-17

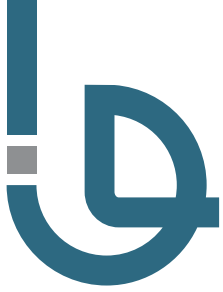

## Scissors

Delicate Dissecting Scissors

delicate



1/2

15,5 cm / 6 1/8"



1/4

MA 218-15



MA 219-15

delicate

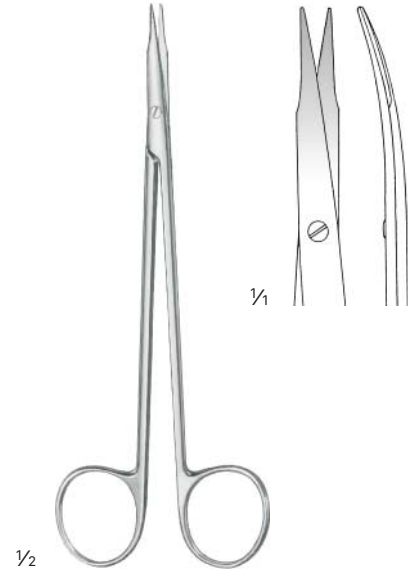

1/2

Jameson  
MA 354-15

15,5 cm / 6 1/8"

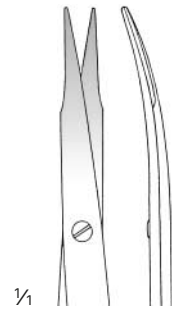

1/4

delicate



1/2

Reynolds



1/4

14 cm / 5 4/8"

MA 232-15



18 cm / 7 1/8"

MA 232-18



14 cm / 5 4/8"

MA 233-15



18 cm / 7 1/8"

MA 233-18



Regular

TC

SC



MA 561-11

MA 886-11

MA 893-11



MA 562-11

MA 887-11

MA 894-11

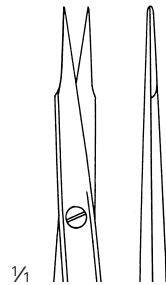

11 cm / 4 3/8"

MA 573-11

sharp/sharp

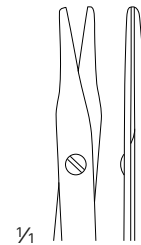

10,5 cm / 4 1/8"

MA 575-10

blunt/blunt



11 cm / 4 3/8"

MA 574-11

sharp/sharp

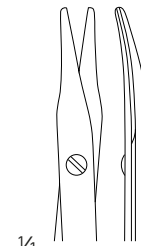

10,5 cm / 4 1/8"

MA 576-10

blunt/blunt

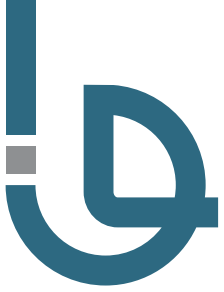

## Scissors

### Operating Scissors



1/2

**Kelly**

16 cm / 6 2/8"

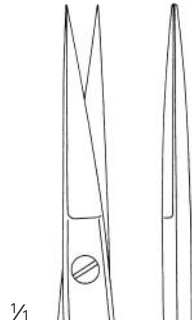

1/4

**MA 134-16**

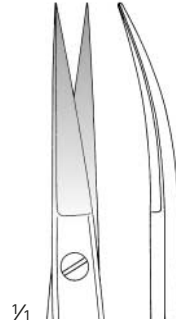

1/4

**MA 135-16**



1/2

**Joseph**

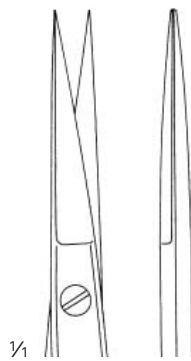

1/4

14,5 cm / 5 6/8"

**Regular**

**MA 228-14**

**TC**

**MA 886-14**

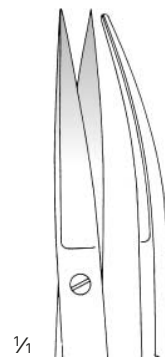

1/4

14,5 cm / 5 6/8"

**MA 229-14**

**MA 887-14**

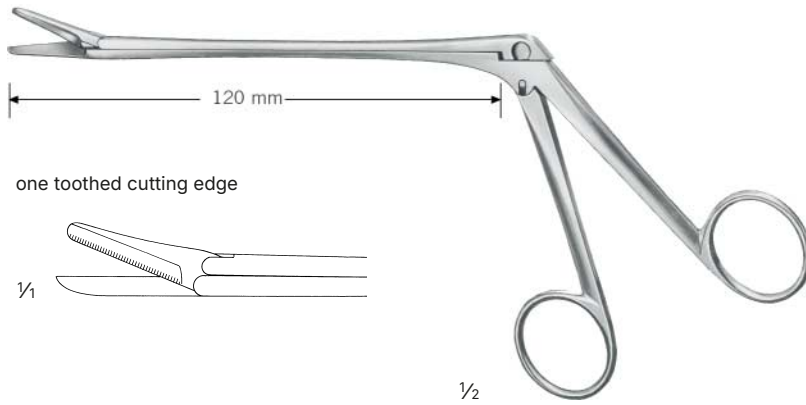

Olivecrona  
MA 309-23  
23 cm / 9"



Strully  
22 cm / 8 5/8"

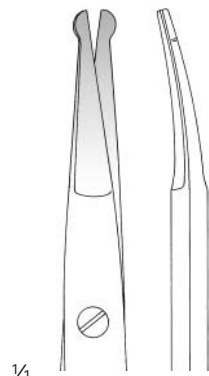

MA 245-22



MA 246-22

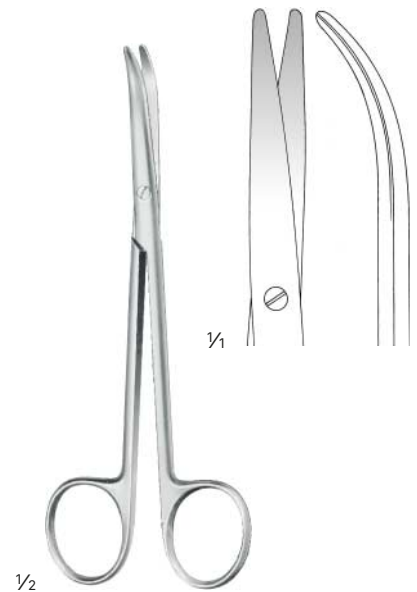

Fomon  
MA 222-13  
14 cm / 5 4/8"

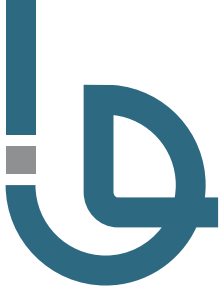

## Scissors

Uterine Scissors, Bandage Scissors

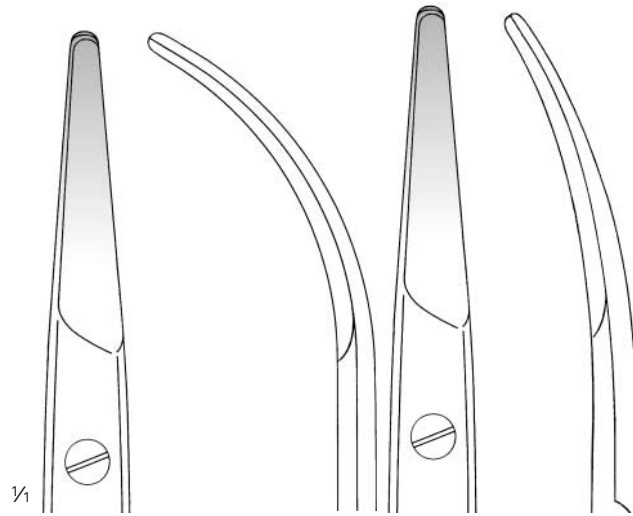

**MA 858-01**

22 cm / 8 <sup>5</sup>/<sub>8</sub>"

**MA 858-02**

23 cm / 9"



**Universal**

12 cm / 4 <sup>9</sup>/<sub>8</sub>" **MA 604-12**

max Ø = 0,4 mm  
soft wire



**MA 889-12**

max Ø = 1,0 mm  
soft wire

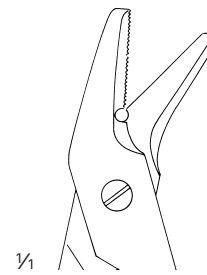

one toothed cutting edge

max Ø = 0,5 mm  
hard wire

# Forceps

Micro Forceps

Delicate Dissecting Forceps

Delicate Tissue Forceps

Dissecting Forceps

Tissue Forceps

Aturamatic Forceps



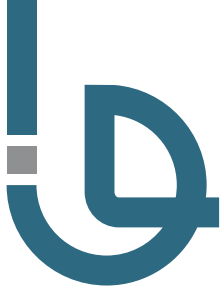

# Forceps

Micro Forceps



1/2

Jeweler Type

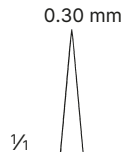

11 cm / 4 3/8" **FO 530-00**

13,5 cm / 5 3/8" **FO 530-01**

Vessel Dilator

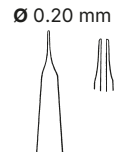

**FO 530-02**

Vessel Dilator

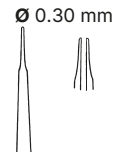

**FO 530-03**

Pierse

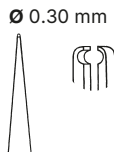

**FO 530-04**

**FO 530-05**

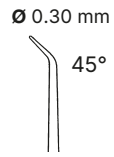

**FO 530-07**

**FO 530-08**



1/2

Jeweler mod.

10°

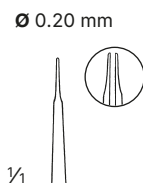

11 cm / 4 3/8" **FO 530-09**

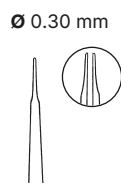

**FO 530-10**



Atraumatic 

1.2 mm

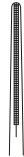

1x2



Ø1.0 x 0.5 mm



1/4



Ø2.0 x 0.8 mm



15 cm / 5 7/8"

FO 990-15

FO 991-15

FO 992-15

18 cm / 7 1/8"

FO 990-18

FO 991-18

FO 992-18

21 cm / 8 2/8"

FO 990-21

FO 991-21

FO 992-21



Ø 0.40 mm



1/4



0.40 mm



0.70 mm



0.70 mm



15 cm / 5 7/8"

FO 993-15

FO 994-15

FO 995-15

FO 996-15

18 cm / 7 1/8"

FO 993-18

FO 994-18

FO 995-18

FO 996-18

21 cm / 8 2/8"

FO 993-21

FO 994-21

FO 995-21

FO 996-21

**Regular**

with tying platform

0.30 mm



1/4

0.30 mm



0.60 mm



0.60 mm



12 cm / 5 7/8"

FO 608-12

FO 609-12

15 cm / 5 7/8"

FO 610-15

FO 611-15

18 cm / 7 1/8"

FO 612-18

FO 613-18

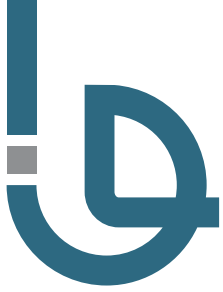

**Forceps**  
Micro Forceps

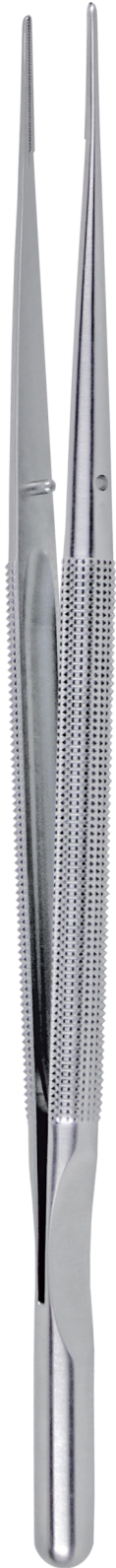

**Atraumatic** <sup>1x2</sup>

1.2 mm



Ø 1.0 x 0.5 mm



Ø2.0 x 08 mm



15 cm / 5 7/8"

**FO 980-15**

**FO 981-15**

18 cm / 7 1/8"

**FO 980-18**

**FO 981-18**

**FO 982-18**

21 cm / 8 1/4"

**FO 980-21**

**FO 981-21**



0.40 mm



0.40 mm



0.70 mm



0.70 mm



15 cm / 5 7/8"

**FO 983-15**

**FO 984-15**

**FO 985-15**

**FO 986-15**

18 cm / 7 1/8"

**FO 983-18**

**FO 984-18**

**FO 985-18**

**FO 986-18**

21 cm / 8 1/4"

**FO 983-21**

**FO 984-21**

**FO 985-21**

**FO 986-21**

Counter Balanced

1/4

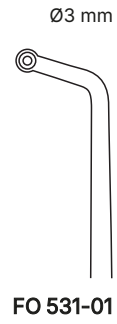

Yasargil-Samii

22 cm / 8 5/8"

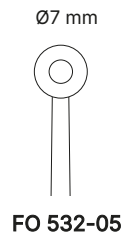
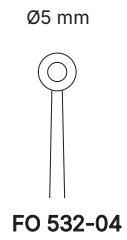
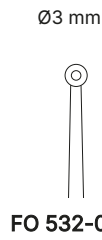
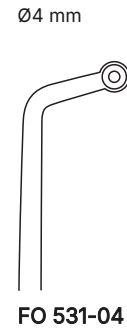
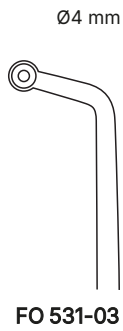

Yasargil

24 cm / 9 3/8"

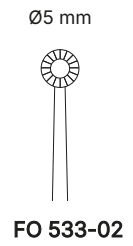
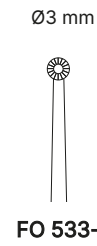
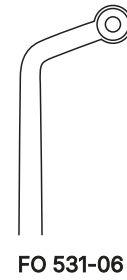
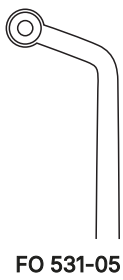

1/2

Samii  
23 cm / 9"

Yasargil  
22 cm / 8 5/8"

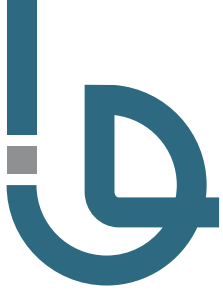

**Forceps**  
Micro Forceps



1/2

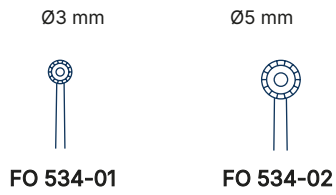

**Heifetz**  
22 cm / 8 5/8"

**Yasargil**

	0,6 mm	0,9 mm	1,2 mm 1x2
16 cm / 6 2/8"	FO 536-16	FO 537-16	FO 538-16
18 cm / 7 1/8"	FO 536-18	FO 537-18	FO 538-18
20 cm / 7 7/8"	FO 536-20	FO 537-20	FO 538-20
22 cm / 8 5/8"	FO 536-22	FO 537-22	FO 538-22
24 cm / 9 4/8"	FO 536-24	FO 537-24	FO 538-24



1/2

**Hunt**  
20 cm / 7 7/8"

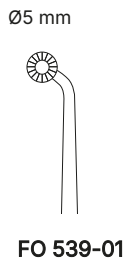

1/2

**Hunt**  
20 cm / 7 7/8"





3 mm



FO 540-01

5 mm

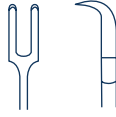











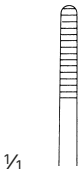

FO 540-02

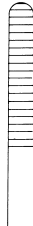
Yasargil  
22 cm / 8 5/8"

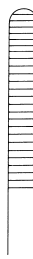
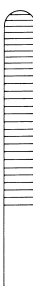
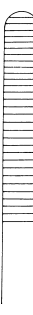
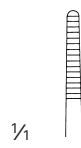

## Forceps

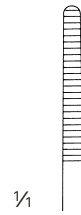
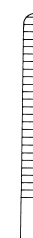
### Dissecting Forceps

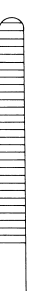
	standard pattern									
										
	<b>FO 100-10</b>	<b>FO 100-11</b>	<b>FO 100-13</b>	<b>FO 100-14</b>	<b>FO 100-16</b>					
	10,5 cm / 4 1/8"	11,5 cm / 4 2/8"	13 cm / 5 1/8"	14,5 cm / 5 6/8"	16 cm / 6 2/8"					
										
					<b>FO 100-18</b>	<b>FO 100-20</b>	<b>FO 100-25</b>	<b>FO 100-30</b>		
					18 cm / 7 1/8"	20 cm / 7 7/8"	25 cm / 9 7/8"	30,5 cm / 12"		
										
										<b>FO 120-10</b>
	10,5 cm / 4 1/8"	11,5 cm / 4 2/8"	13 cm / 5 1/8"	14,5 cm / 5 6/8"						16 cm / 6 2/8"
										
<b>FO 120-18</b>										<b>FO 120-20</b>
18 cm / 7 1/8"					20 cm / 7 7/8"	25 cm / 9 7/8"	30 cm / 11 6/8"			

standard pattern



1x2



1/2

1/4



**FO 110-10**

10,5 cm / 4 1/8"



**FO 110-11**

11,5 cm / 4 2/8"



**FO 110-13**

13 cm / 5 1/8"



**FO 110-14**

14,5 cm / 5 6/8"

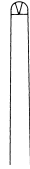

**FO 110-16**

16 cm / 6 2/8"

1/4

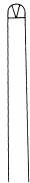

**FO 110-18**

18 cm / 7 1/8"



**FO 110-20**

20,5 cm / 8 1/8"



**FO 110-25**

25 cm / 9 7/8"



**FO 110-30**

30,5 cm / 12"

medium width



1x2



1/2

1/4



**FO 130-13**

13 cm / 5 1/8"



**FO 130-14**

14,5 cm / 5 6/8"



**FO 130-16**

16 cm / 6 2/8"



**FO 130-18**

18 cm / 7 1/8"

1/4



**FO 130-20**

20,5 cm / 8 1/8"



**FO 130-25**

25 cm / 9 7/8"

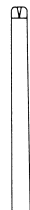

**FO 130-30**

30 cm / 11 6/8"

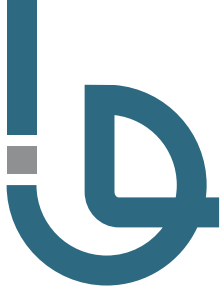

# Forceps

Tissue Forceps



1/2



3x4

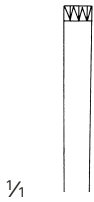

1/4

**FO 112-14**

14,5 cm / 5 7/8"

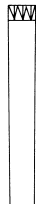

**FO 112-16**

16 cm / 6 2/8"



**FO 112-20**

20 cm / 7 7/8"



1/2

14,5 cm / 5 7/8"



1/4

**FO 121-14**



1x2



1/4

**FO 131-14**



4x5

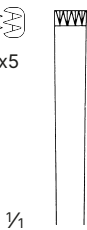

1/4

**FO 113-14**

14,5 cm / 5 7/8"



**FO 113-15**

16 cm / 6 2/8"

1/2

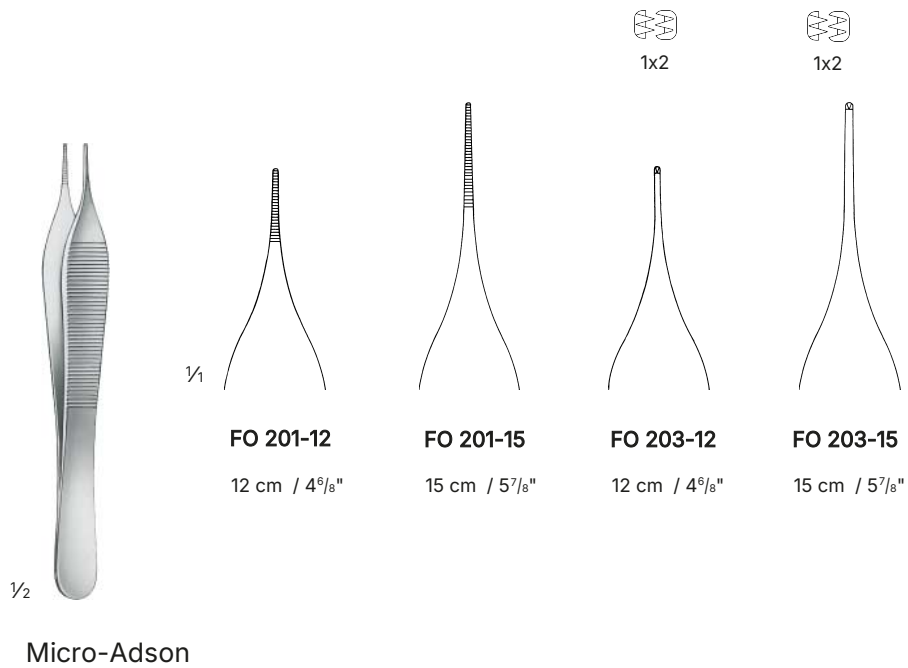
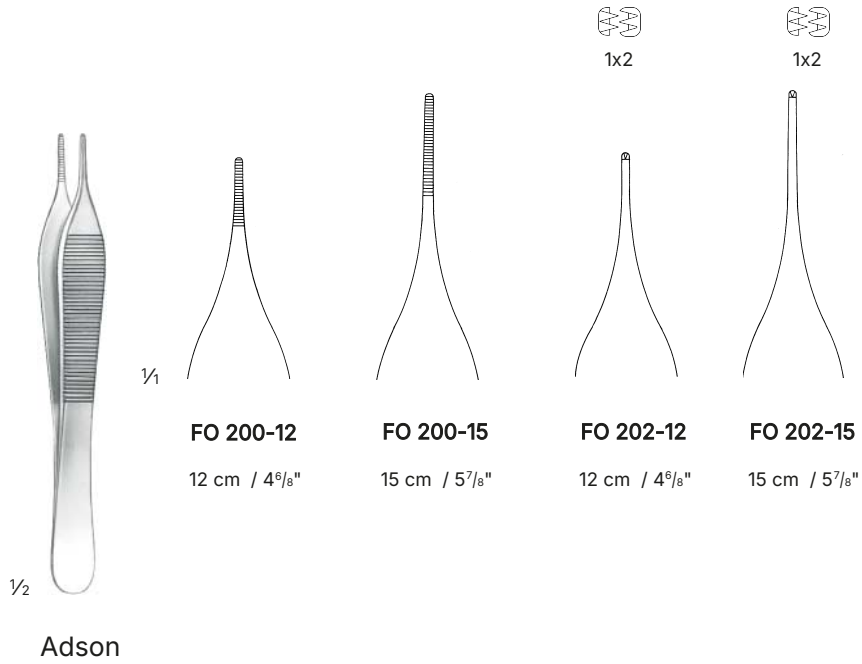

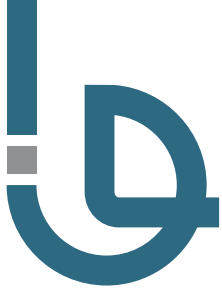

# Forceps

Dissecting Forceps, Tissue Forceps



1/2

**Adson-Brown**  
12 cm / 4 7/8"

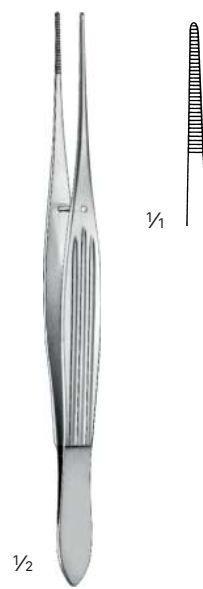
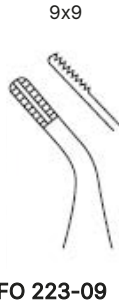
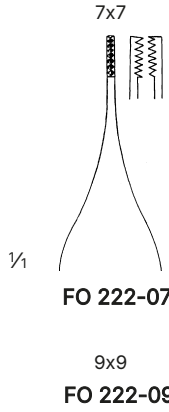

1/2

**McIndoe**  
FO 225-15  
15 cm / 5 7/8"

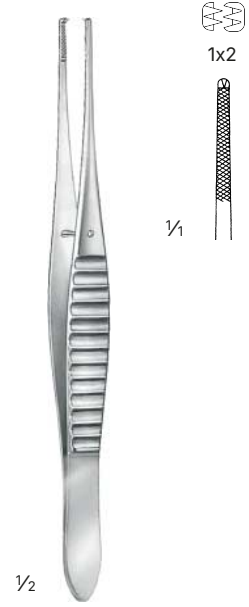

1/2

**Gillies**  
FO 510-15  
15,5 cm / 6 1/8"



1/2

**Semken**

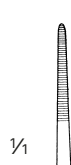

**FO 226-12**  
12,5 cm / 4 7/8"



**FO 226-15**  
15 cm / 5 7/8"



**FO 228-12**  
12,5 cm / 4 7/8"



**FO 228-15**  
15 cm / 5 7/8"



**FO 227-12**

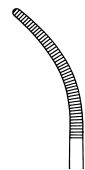

**FO 227-15**



**FO 229-12**



**FO 229-15**

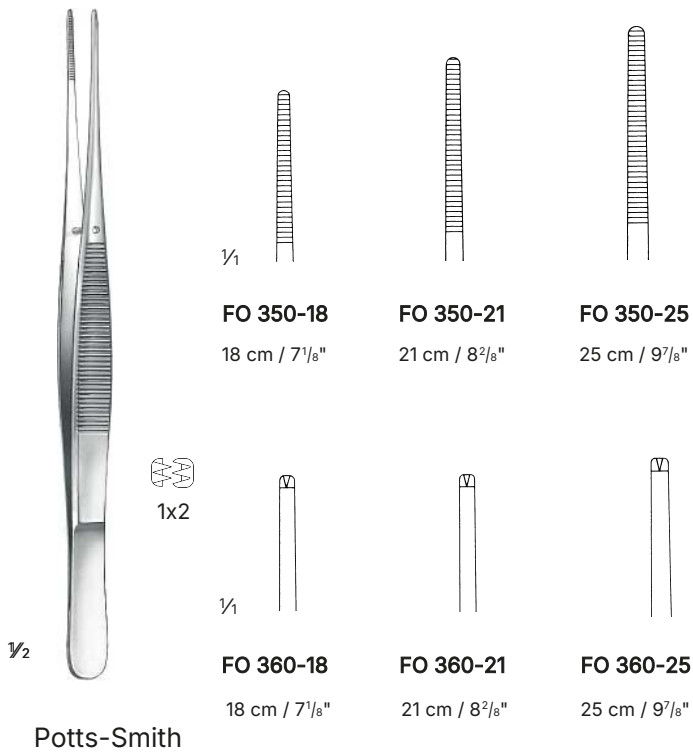
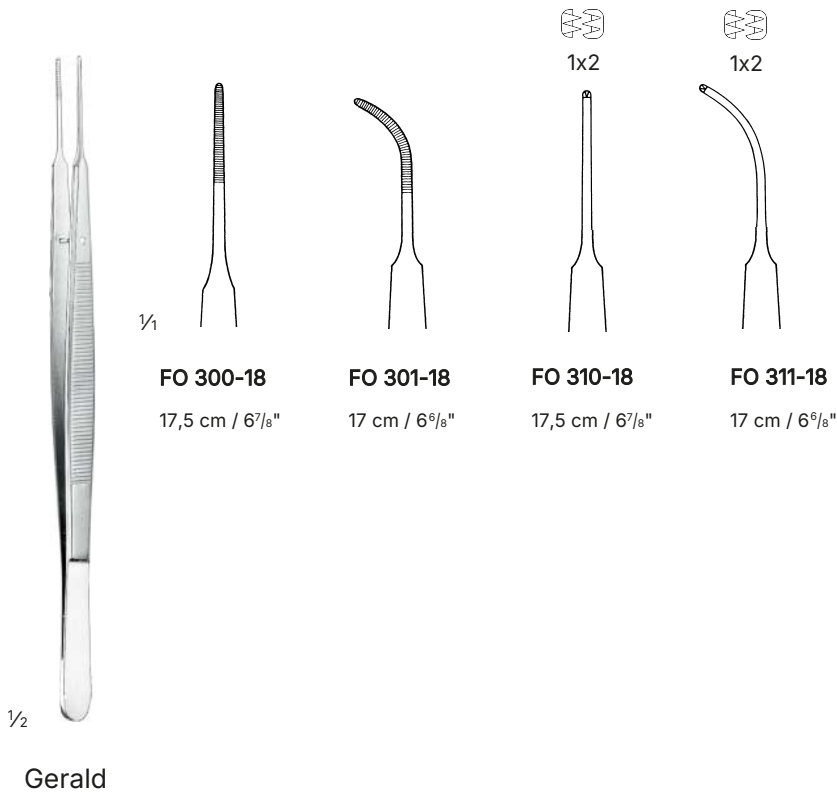

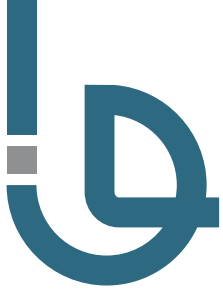

## Forceps

Dissecting Forceps, Tissue Forceps



 TC





$\frac{1}{2}$

**Potts-Smith**

 0.5

	
<b>FO 400-15</b>	<b>FO 400-18</b>
16 cm / $6\frac{2}{8}$ "	18,5 cm / $7\frac{2}{8}$ "

  







		
$\frac{1}{4}$		
<b>FO 400-20</b>	<b>FO 400-23</b>	<b>FO 400-25</b>
20 cm / $7\frac{7}{8}$ "	23 cm / 9"	25 cm / $9\frac{7}{8}$ "



$\frac{1}{2}$

**Adson**

 0.5

			
$\frac{1}{4}$		 1x2	 1x2
<b>FO 405-12</b>	<b>FO 405-15</b>	<b>FO 406-12</b>	<b>FO 406-15</b>
12 cm / $4\frac{6}{8}$ "	15 cm / $5\frac{7}{8}$ "	12 cm / $4\frac{6}{8}$ "	15 cm / $5\frac{7}{8}$ "

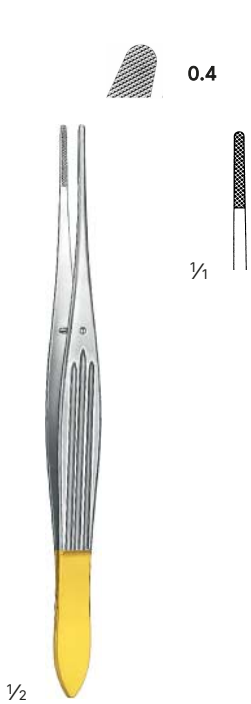

**McIndoe**  
**FO 407-15**  
15 cm / 5<sup>7</sup>/<sub>8</sub>"

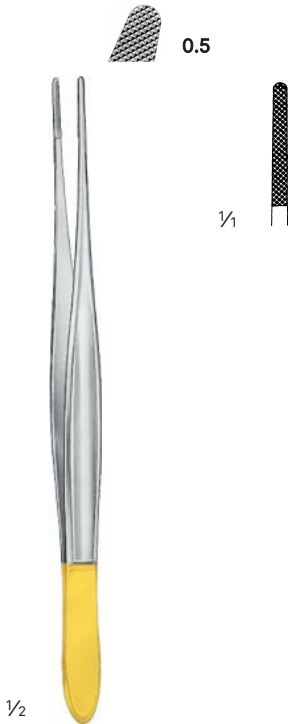

**Cushing**  
**FO 407-17**  
17,5 cm / 6<sup>7</sup>/<sub>8</sub>"

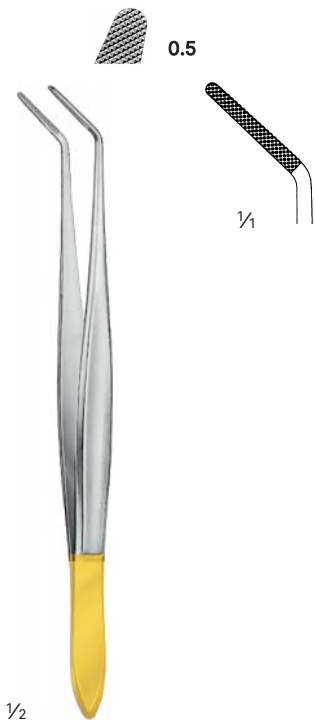

**Cushing**  
**FO 408-17**  
17 cm / 6<sup>6</sup>/<sub>8</sub>"



**Cushing-Taylor**  
**FO 409-18**  
18,5 cm / 7<sup>2</sup>/<sub>8</sub>"



**Forceps**  
Atraumatic Forceps

**Atraumatic** <sup>1x2</sup>



1/2

De Bakey

1,5 mm

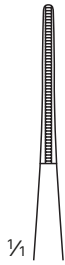

1/4

**FO 950-16**  
16 cm / 6 2/8"

1,5 mm

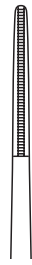

**FO 950-20**  
20 cm / 7 7/8"

1,5 mm

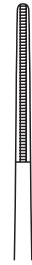

**FO 950-24**  
24 cm / 9 3/8"

2,0 mm

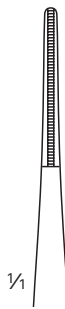

1/4

**FO 951-16**  
16 cm / 6 2/8"

2,0 mm

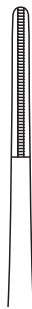

**FO 951-20**  
20 cm / 7 7/8"

2,0 mm



**FO 951-24**  
24 cm / 9 3/8"

2,0 mm



**FO 951-30**  
30 cm / 11 5/8"

2,7 mm

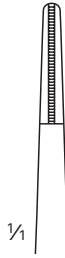

1/4

**FO 952-16**  
16 cm / 6 2/8"

2,7 mm

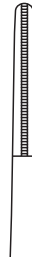

**FO 952-20**  
20 cm / 7 7/8"

2,7 mm



**FO 952-24**  
24 cm / 9 3/8"

2,7 mm



**FO 952-30**  
30 cm / 11 5/8"

3,5 mm

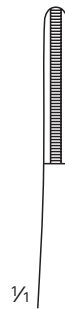

1/4

**FO 953-16**  
16 cm / 6 2/8"

3,5 mm



**FO 953-20**  
20 cm / 7 7/8"

3,5 mm



**FO 953-24**  
24 cm / 9 3/8"

3,5 mm



**FO 953-30**  
30 cm / 11 5/8"

Atraumatic  <sup>1x2</sup>



1/2

De Baakey

2,0 mm



1/1

**FO 954-16**  
16 cm / 6 2/8"

2,0 mm

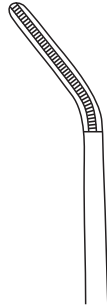

**FO 954-20**  
20 cm / 7 7/8"

2,0 mm

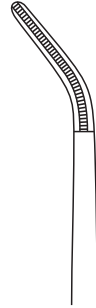

**FO 954-24**  
24 cm / 9 3/8"

2,0 mm



**FO 954-30**  
30 cm / 11 6/8"

1,2 mm



**FO 960-15**  
15 cm / 6"

1,2 mm



**FO 960-20**  
20 cm / 7 7/8"

1,2 mm



**FO 960-24**  
24 cm / 9 1/2"



1/2

De Baakey Ultra-Light



**Forceps**  
Ear Forceps



$\frac{1}{2}$   
**Gruenwald**  
**FO 703-14**  
14,5 cm / 5  $\frac{6}{8}$ "

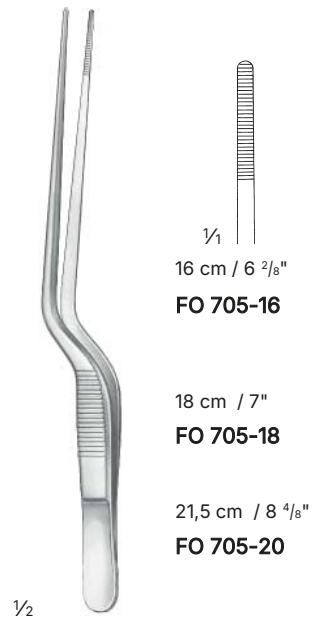

$\frac{1}{2}$   
**Jansen**

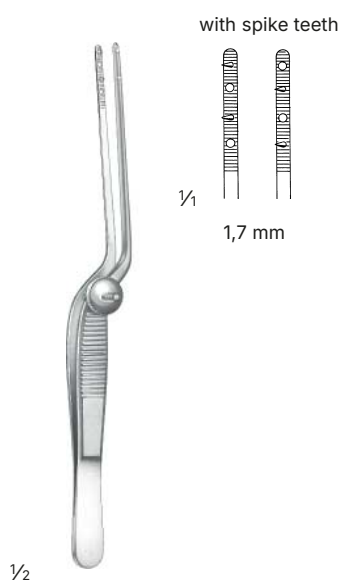

$\frac{1}{2}$   
**Cottle**  
**FO 706-14**  
14 cm / 5  $\frac{4}{8}$ "

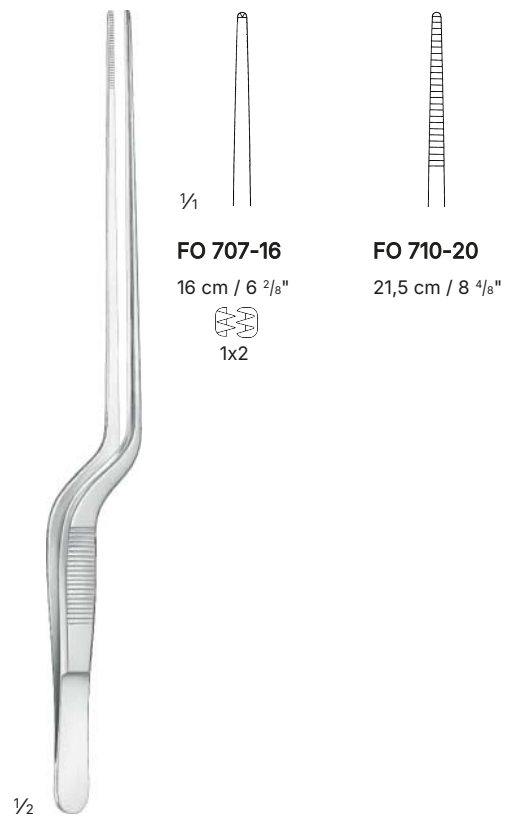

$\frac{1}{2}$   
**Gruenwald-Jansen**

# Clamps

Approximators

Micro Bulldog Clamps

Bulldog Clamps

Hemostatic Clamps

Dissecting and Ligature Clamps

Bile Duct Clamps

Kidney Pedicle Clamps

Peritoneum Clamps

Hysterectomy Clamps





## Clamps

Applying Forceps, Micro Bulldog Clamps, Approximator



1/2



HM 482-01  
HM 483-05



1/1

**Biemer**

Total length:

Jaw length:



1/1

**HM 482-01**

14 mm

6 mm



**HM 482-02**

17 mm

9 mm



**HM 482-03**

17 mm

9 mm

**HM 482-00**

14,5 cm / 5 9/16"

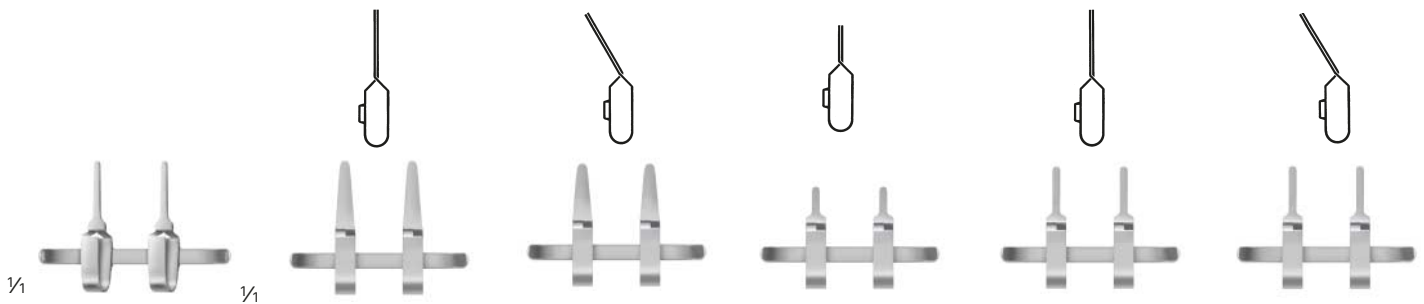

1/1

1/1

**Biemer-Müller**

straight, wide

**HM 483-01**

Total length:

Jaw length:

17 mm

9 mm

angled, wide

**HM 483-02**

17 mm

9 mm

straight, narrow

**HM 483-03**

13 mm

4,5 mm

straight, narrow

**HM 483-04**

17 mm

9 mm

angled, narrow

**HM 483-05**

17 mm

9 mm

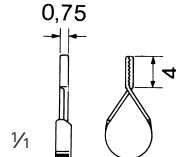
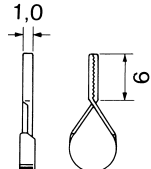
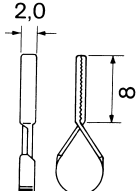
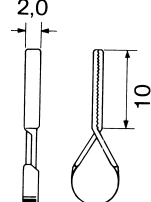
				
1/4	1/4			
	<b>HM 484-01</b>	<b>HM 484-02</b>	<b>HM 484-03</b>	<b>HM 484-04</b>
Total length:	1,3 cm	1,5 cm	1,7 cm	2,0 cm
Jaw length:	4 mm	6 mm	8 mm	10 mm



1/2

**HM 484-00**

18,5 cm / 7 2/8"



HM 484-01  
HM 484-04

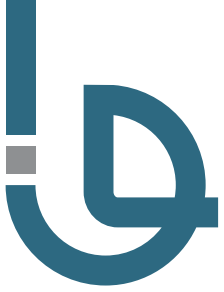

# Clamps

## Hemostatic Clamps



Halsted-Mosquito

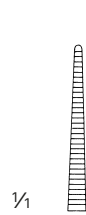

**HM 440-12**  
12,5 cm / 4 7/8"



**HM 440-14**  
14,5 cm / 5 6/8"



**HM 441-12**  
12 cm / 4 6/8"



**HM 441-14**  
14 cm / 5 4/8"

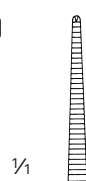

**HM 442-12**  
12,5 cm / 4 7/8"



**HM 442-14**  
14,5 cm / 5 6/8"



**HM 443-12**  
12,5 cm / 4 7/8"



**HM 443-14**  
14,5 cm / 5 6/8"

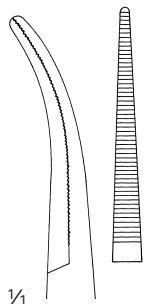

**HM 424-14**  
14,5 cm / 5 6/8"

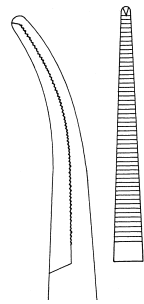

**HM 425-14**  
14,5 cm / 5 6/8"



**HM 454-14**  
14 cm / 5 4/8"

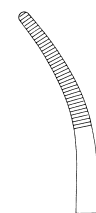

**HM 455-14**  
13,5 cm / 5 3/8"



Dandy  
laterally curved



Providence-Hospital



1/2

Kelly

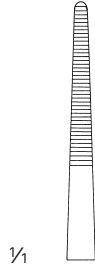

1/1

**HM 460-14**  
14,5 cm / 5 9/16"

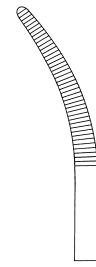

**HM 461-14**  
14 cm / 5 4/8"



1/2

Crile  
14,5 cm / 5 9/16"

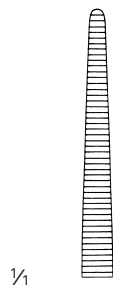

1/1

**HM 466-14**



**HM 467-14**



1x2

**HM 468-14**



1x2

**HM 469-14**



## Clamps

### Hemostatic Clamps

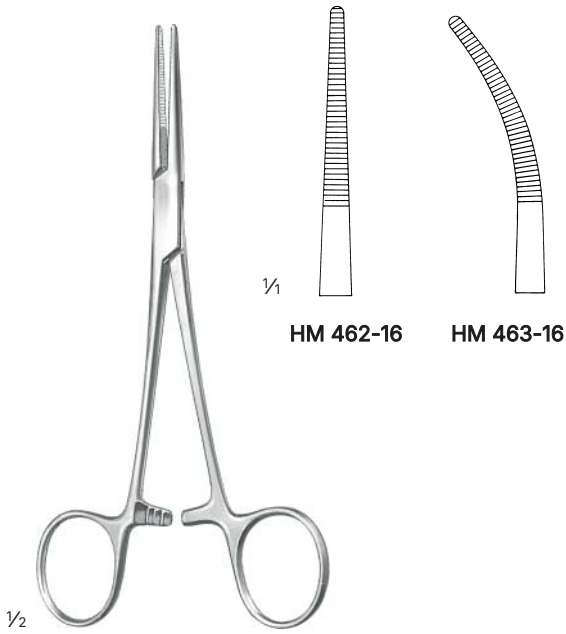

**Kelly-Rankin**  
16 cm / 6 2/8"

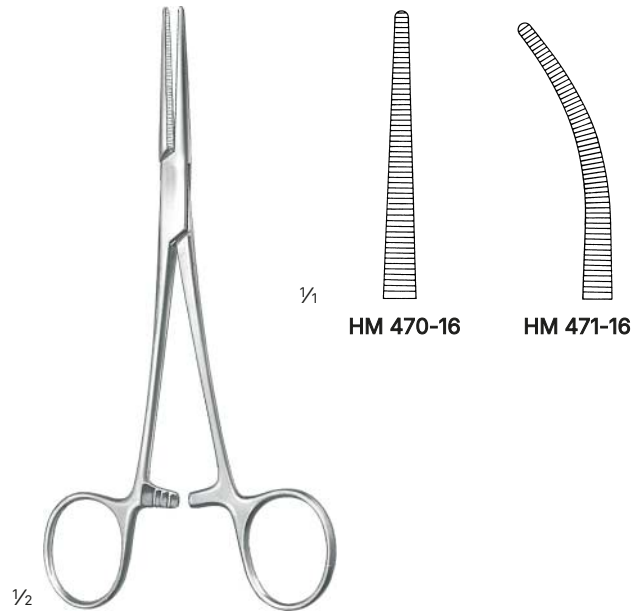

**Crile-Rankin**  
16 cm / 6 2/8"



**Halsted-Mosquito**

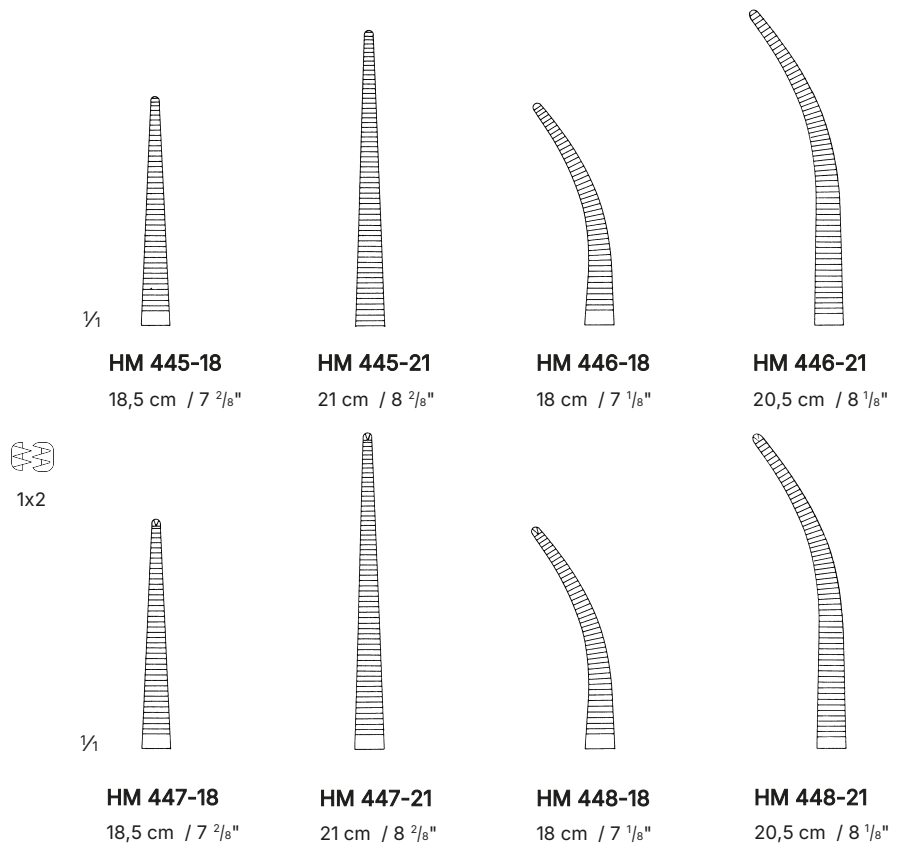



1/2

Pean

1/1



**HM 427-13**  
13,5 cm / 5 3/8"



**HM 427-14**  
14,5 cm / 5 9/8"



**HM 427-16**  
17 cm / 6 9/8"



**HM 428-13**  
13 cm / 5 1/8"



**HM 428-14**  
14 cm / 5 4/8"

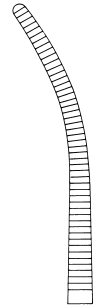

**HM 428-16**  
16,5 cm / 6 4/8"



1/2

Kocher

1x2

1/1



**HM 429-13**  
13 cm / 5 1/8"



**HM 429-14**  
14 cm / 5 4/8"



**HM 429-16**  
16 cm / 6 2/8"



**HM 432-13**  
13 cm / 5 1/8"



**HM 432-14**  
14 cm / 5 4/8"



**HM 432-16**  
16 cm / 6 2/8"

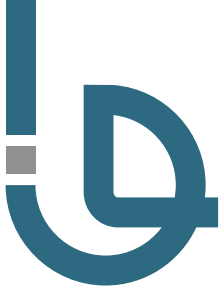

## Clamps

Hemostatic Clamps

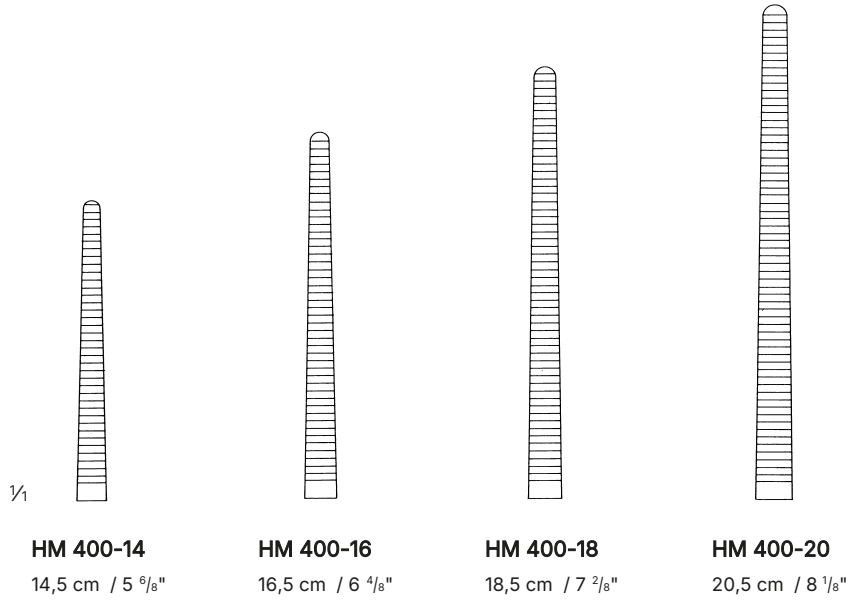

Pean -Rochester

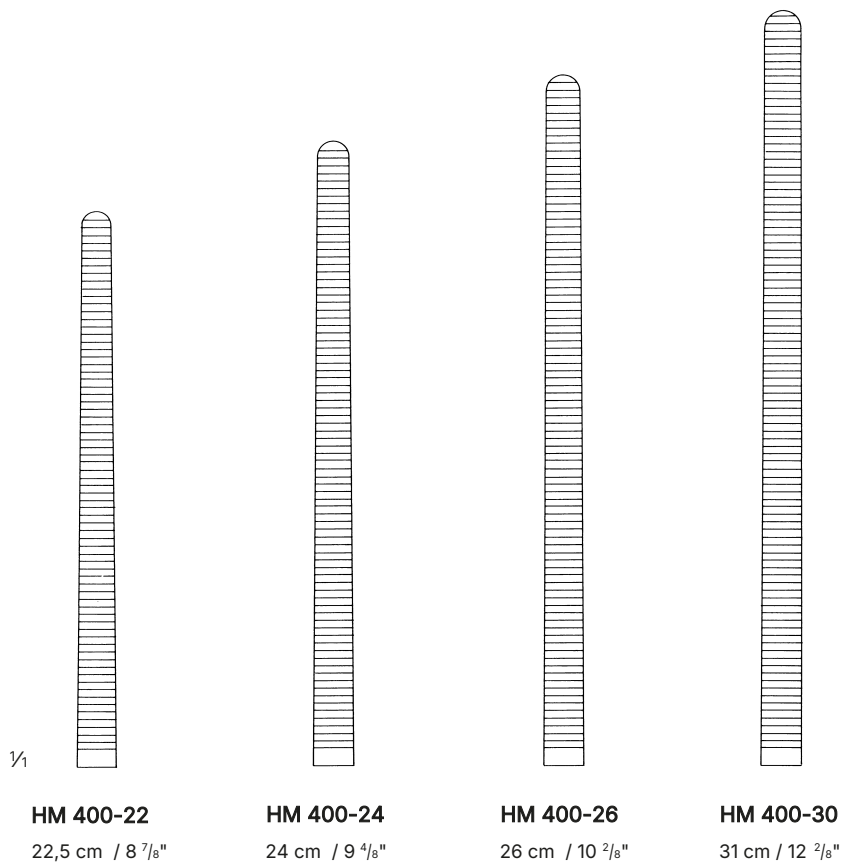

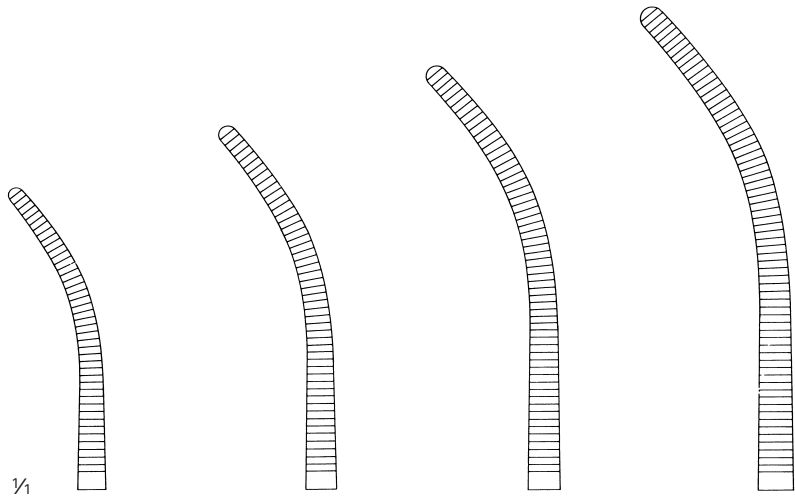

1/1

**HM 401-14**  
14 cm / 5 4/8"

**HM 401-16**  
16,5 cm / 6 4/8"

**HM 401-18**  
18,5 cm / 7 2/8"

**HM 401-20**  
20,5 cm / 8 1/8"



1/2

**Pean -Rochester**

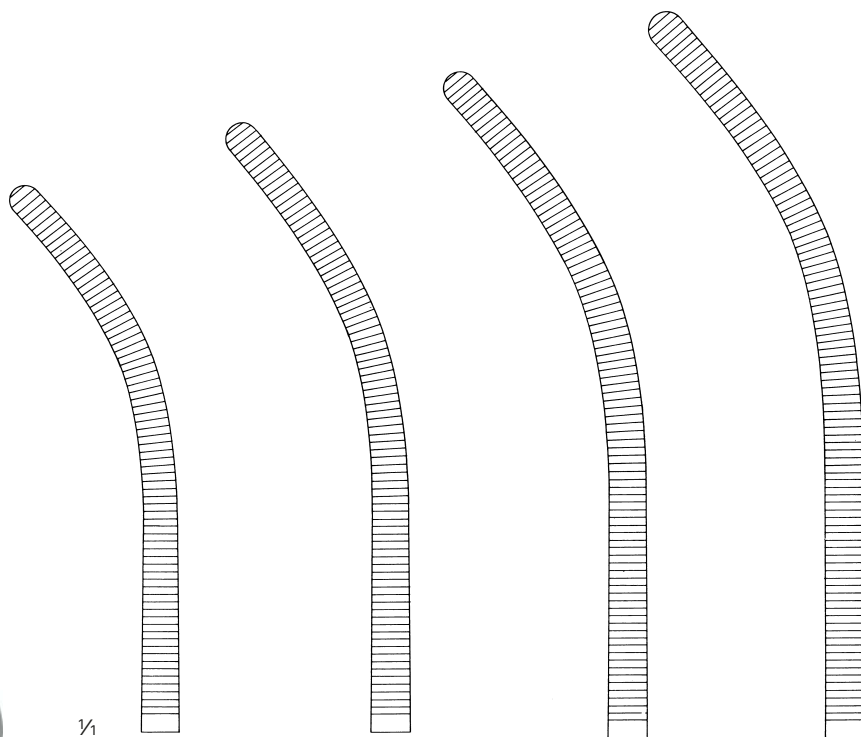

1/1

**HM 401-22**  
22 cm / 8 5/8"

**HM 401-24**  
24 cm / 9 4/8"

**HM 401-26**  
26 cm / 10 2/8"

**HM 401-30**  
30,5 cm / 12"

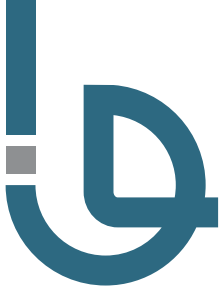

## Clamps

Hemostatic Clamps

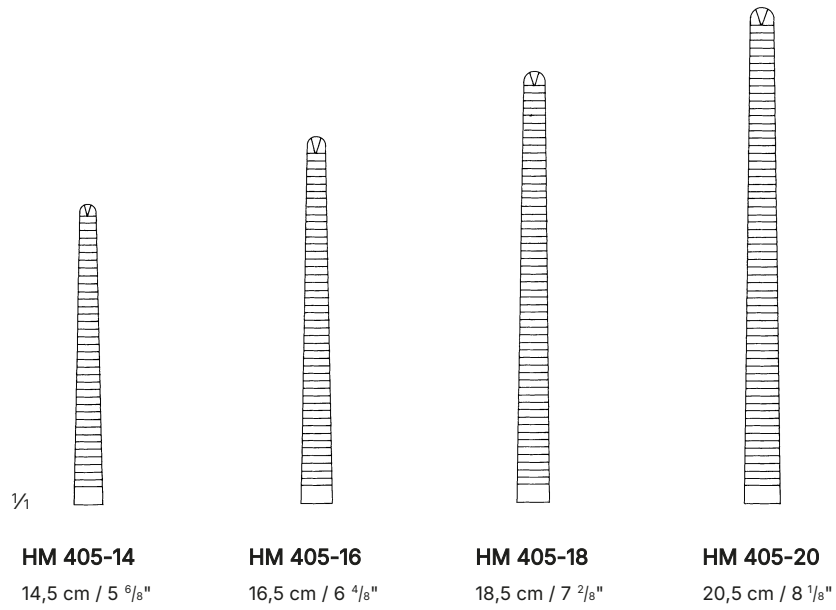

**HM 405-14**  
14,5 cm / 5 6/8"

**HM 405-16**  
16,5 cm / 6 4/8"

**HM 405-18**  
18,5 cm / 7 2/8"

**HM 405-20**  
20,5 cm / 8 1/8"



Kocher -Ochsner

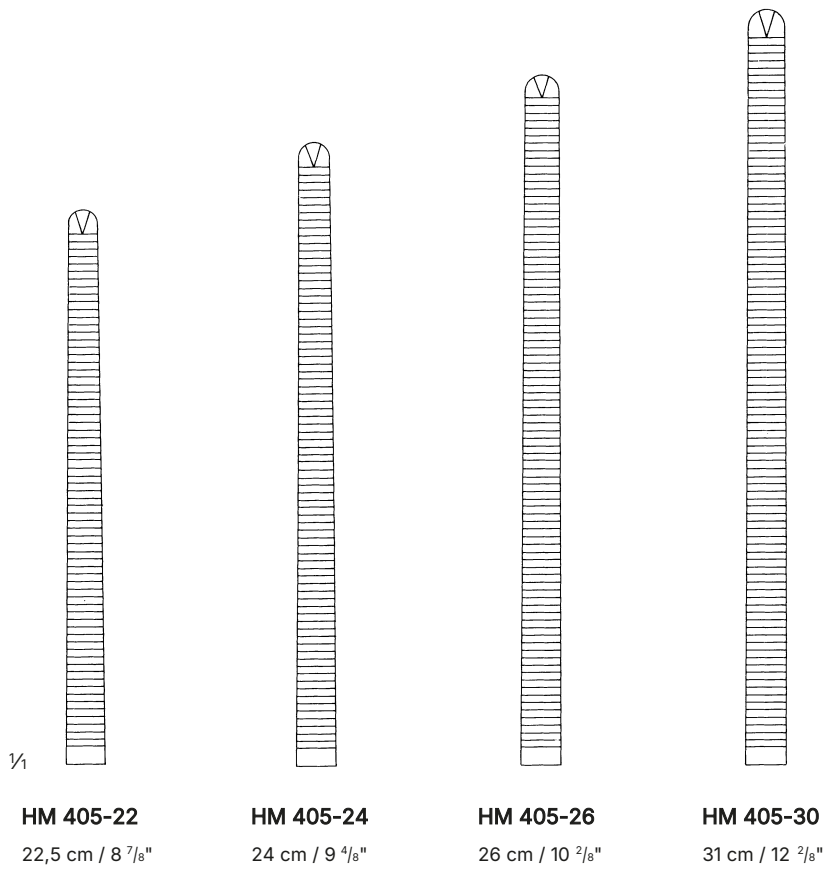

**HM 405-22**  
22,5 cm / 8 7/8"

**HM 405-24**  
24 cm / 9 4/8"

**HM 405-26**  
26 cm / 10 2/8"

**HM 405-30**  
31 cm / 12 2/8"

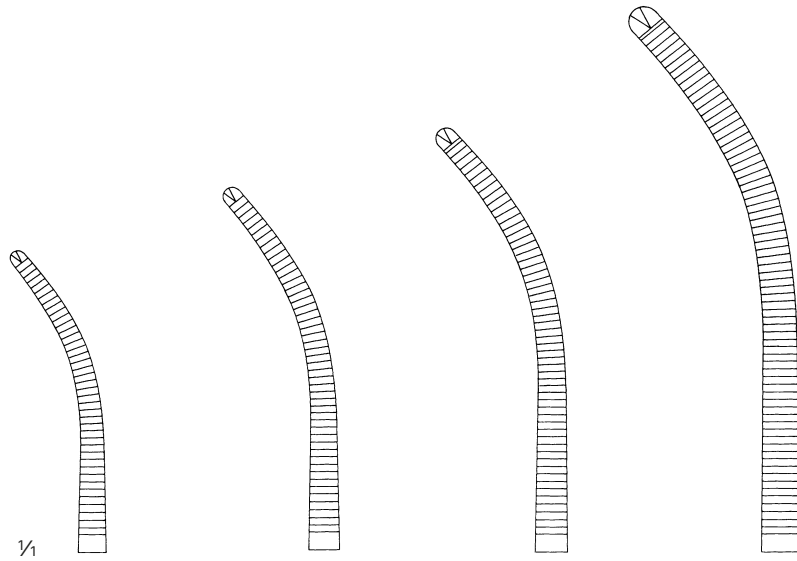

1/1

**HM 406-14**  
14 cm / 5 4/8"

**HM 406-16**  
16,5 cm / 6 4/8"

**HM 406-18**  
18,5 cm / 7 2/8"

**HM 406-20**  
20 cm / 7 7/8"



1/2

Kocher -Ochsner

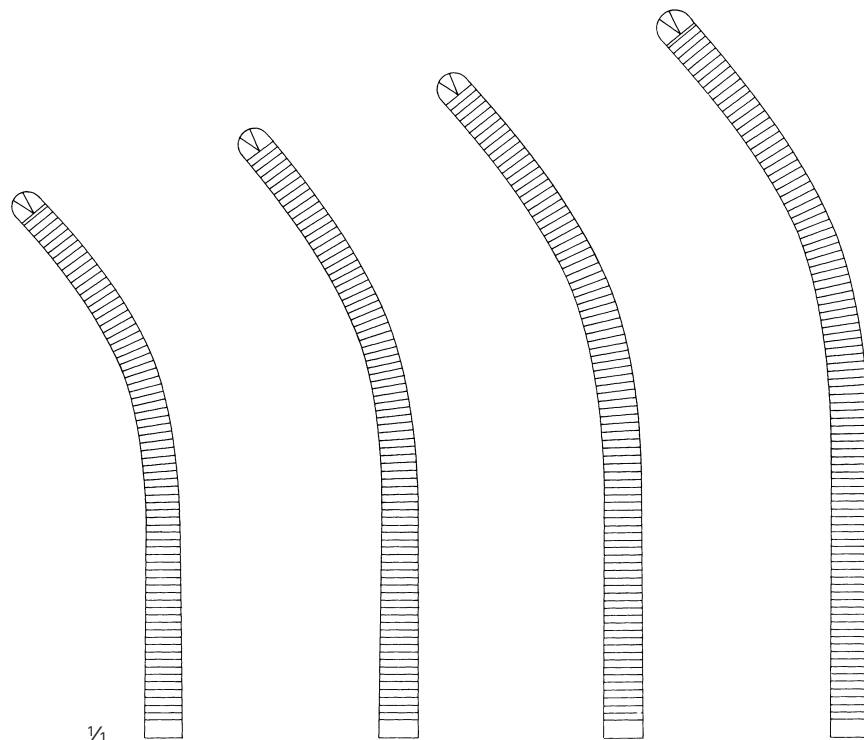

1/1

**HM 406-22**  
22,5 cm / 8 7/8"

**HM 406-24**  
24 cm / 9 4/8"

**HM 406-26**  
26 cm / 10 2/8"

**HM 406-30**  
30,5 cm / 12"

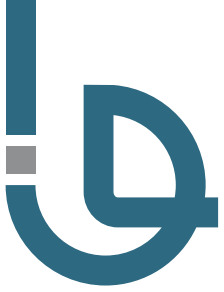

## Clamps

Dissecting and Ligature Clamps



1/2

Baby-Adson

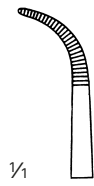

1/1

**HM 415-14**

14,5 cm / 5 7/8"

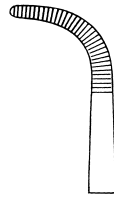

**HM 415-18**

18 cm / 7 1/8"



1/2

Mixer-Baby

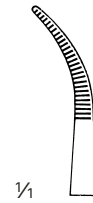

1/1

**HM 520-01**

13,5 cm / 5 3/8"

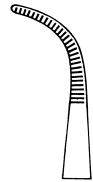

**HM 520-02**

13 cm / 5 1/8"



1/2

Mixer-Baby

**HM 522-18**

18,5 cm / 7 3/8"



1/1

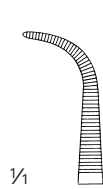

**HM 532-14**  
13 cm / 5 1/8"

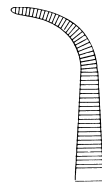

**HM 532-16**  
16 cm / 6 2/8"

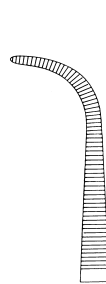

**HM 532-18**  
18 cm / 7 1/8"

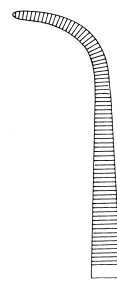

**HM 532-20**  
21 cm / 8 2/8"



1/2

**Gemini**

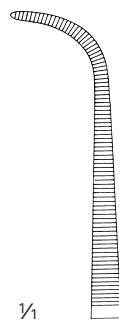

**HM 532-23**  
23 cm / 9"

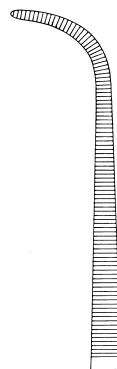

**HM 532-25**  
25 cm / 9 7/8"

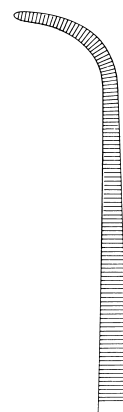

**HM 532-28**  
28 cm / 11"



## Clamps

Dissecting and Ligature Clamps



1/2

Overholt-Geissendoerfer

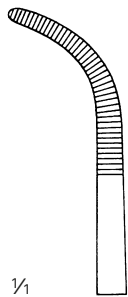

1/1

Fig. 1

**HM 420-01**

20,5 cm / 8 1/8"

**HM 421-01**

27 cm / 10 5/8"

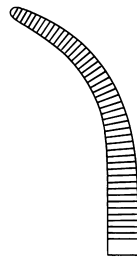

Fig. 2

**HM 420-02**

20 cm / 7 7/8"

**HM 421-02**

26,5 cm / 10 3/8"

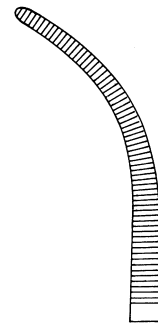

Fig. 3

**HM 420-03**

21,5 cm / 8 4/8"

**HM 421-03**

27,5 cm / 10 7/8"

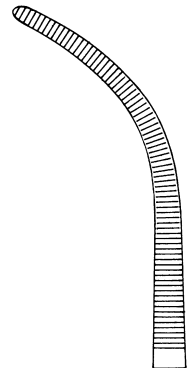

Fig. 4

**HM 420-04**

22 cm / 8 5/8"

**HM 421-04**

28 cm / 11"

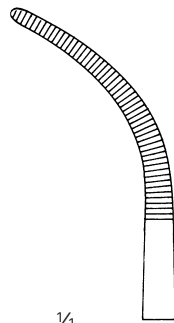

1/1

Fig. 5

**HM 420-05**

21,5 cm / 8 4/8"

**HM 421-05**

27,5 cm / 10 7/8"

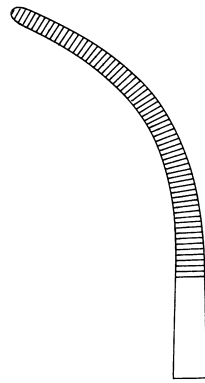

Fig. 6

**HM 420-06**

21,5 cm / 8 2/8"

**HM 421-06**

28 cm / 11"

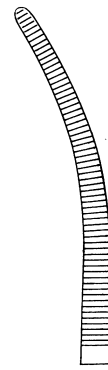

Fig. 7

**HM 420-07**

22 cm / 8 5/8"

**HM 421-07**

27,5 cm / 10 7/8"

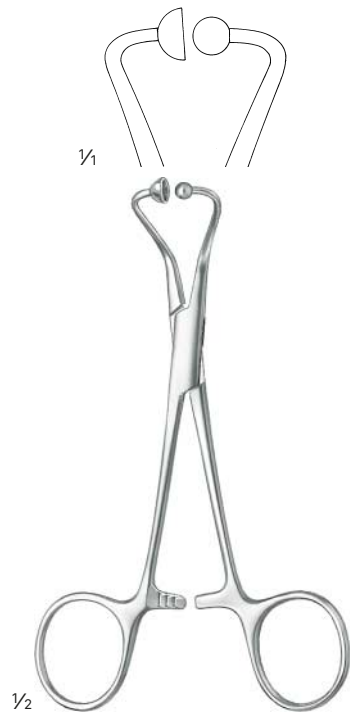

**HM 861-13**  
14 cm / 5 4/8"  
for paper drapes

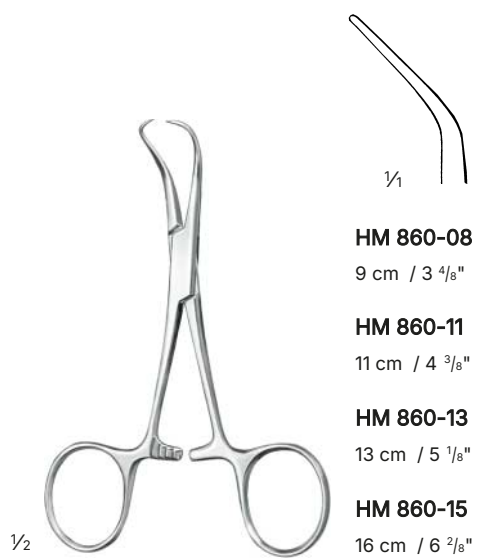

**Backhaus**  
sharp

**HM 860-08**  
9 cm / 3 4/8"

**HM 860-11**  
11 cm / 4 3/8"

**HM 860-13**  
13 cm / 5 1/8"

**HM 860-15**  
16 cm / 6 2/8"

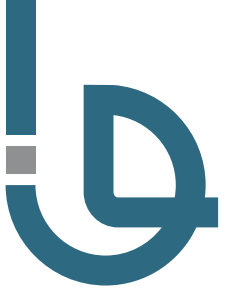

# Needle Holders and Suture Instruments

Micro Needle Holders

Needle Holders

Ligature Needles

Clip Applying and Removing Forceps



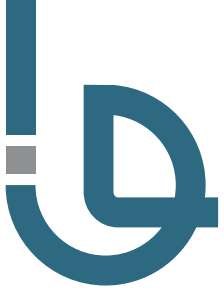

# Needle Holders and Suture Instruments

## Micro Needle Holders

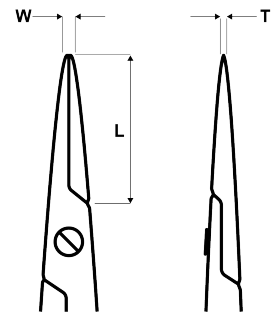

Length x Thickness x Width



1/4

**Barraquer-Troutman**

12 cm / 4 3/4"



**9-0 and smaller**

10 x 0,75 x 1,0 mm

1/4



without ratchet

**PO 100-10**

**PO 101-10**

with ratchet

**PO 102-10**

**PO 103-10**

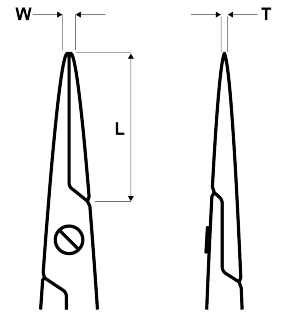

Length x Thickness x Width



With ratchet



9-0 and smaller

12 x 0,8 x 1,2 mm



0,3



7-0 and smaller

13 x 1,3 x 2,0 mm

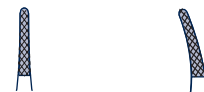

14,5 cm / 5 7/8"

PO 105-14

PO 106-14

PO 966-01

PO 966-02

18 cm / 7 1/8"

PO 110-15

PO 111-15

PO 968-01

PO 968-02

21 cm / 8 2/8"

PO 117-18

PO 118-18

PO 970-01

PO 970-02

23 cm / 9"

PO 970-03

PO 970-04



# Needle Holders and Suture Instruments

## Micro Needle Holders

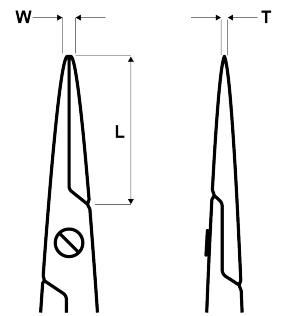

Length x Thickness x Width

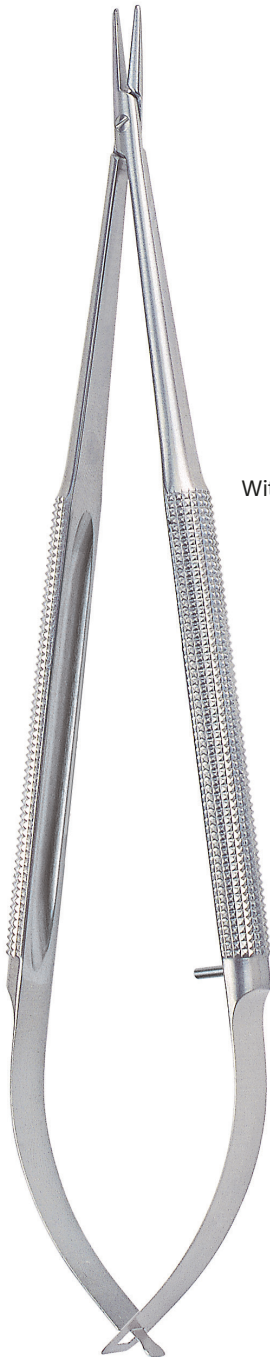

Without ratchet



9-0 and smaller

12 x 0,8 x 1,2 mm



14,5 cm / 5 6/8"

PO 104-13

PO 104-14

18 cm / 7 1/8"

PO 108-15

PO 109-15

21 cm / 8 2/8"

PO 115-18

PO 116-18



0,3



7-0 and smaller

13 x 1,3 x 2,0 mm



PO 965-01

PO 965-02

PO 967-01

PO 967-02

PO 969-01



PO 969-02

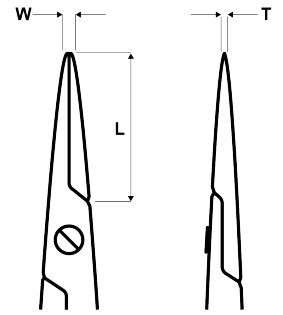

With ratchet



 **TC**

-  0,3
-  6-0 and smaller
- 17 x 2,0 x 3,0
-  1/1

18 cm / 7 1/8"

**PO 921-18**

23 cm / 9"

**PO 921-23**

1/1

Heavy Pattern

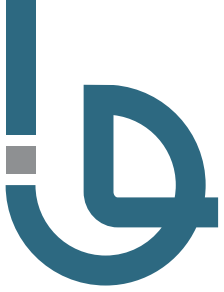

# Needle Holders and Suture Instruments

## Micro Needle Holders

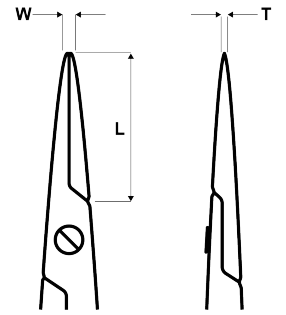

Length x Thickness x Width



7-0 and smaller

12 x 1,2 x 1,6 mm



with ratched

without ratched

with ratched

without ratched

14 cm / 5 1/2"

**PO 121-09**

**PO 119-09**

**PO 122-09**

**PO 120-09**

18 cm / 7 1/8"

**PO 127-14**

**PO 123-14**

**PO 128-14**

**PO 124-14**

21 cm / 8 2/8"

**PO 132-16**

**PO 131-16**

**PO 132-18**

**PO 131-18**

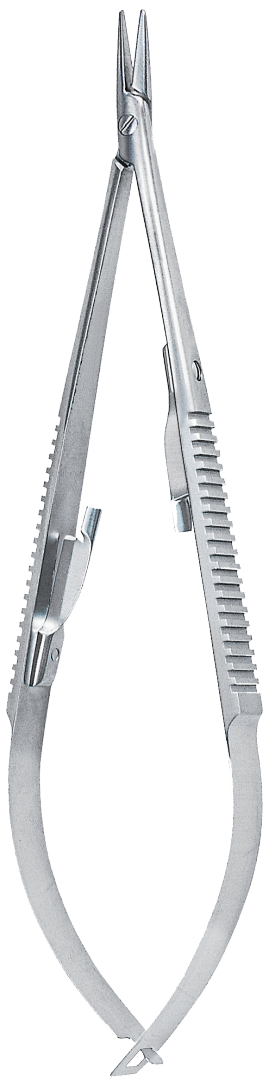

1/1

Castroviejo



0,3



6-0 and smaller

13 x 1,6 x 2,3 mm



with ratched

without ratched

with ratched

without ratched

14 cm / 5 1/2"

**PO 952-14**

**PO 950-14**

**PO 953-14**

**PO 951-14**

18 cm / 7 1/8"

**PO 956-18**

**PO 954-18**

**PO 957-18**

**PO 955-18**

21 cm / 8 2/8"

**PO 959-01**

**PO 958-01**

**PO 959-02**

**PO 958-02**

23 cm / 9"

**PO 959-03**

**PO 959-04**



Yasargil



7-0 and smaller

12 x 1,0 x 1,5



PO 136-16



PO 137-16



PO 136-18



PO 137-18

20 cm / 7 7/8"

22 cm / 8 5/8"



12-0 and smaller

12 x 1,0 x 1,5



PO 136-20



PO 137-20



PO 136-22



PO 137-22

20 cm / 7 7/8"

22 cm / 8 5/8"

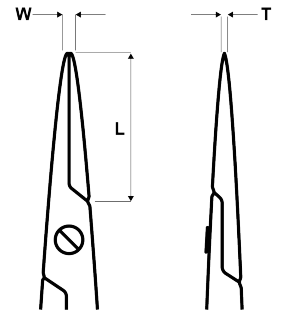

Length x Thickness x Width

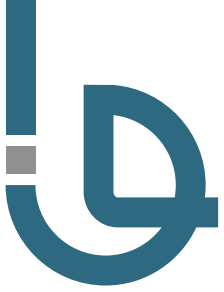

# Needle Holders and Suture Instruments

## Needle Holders

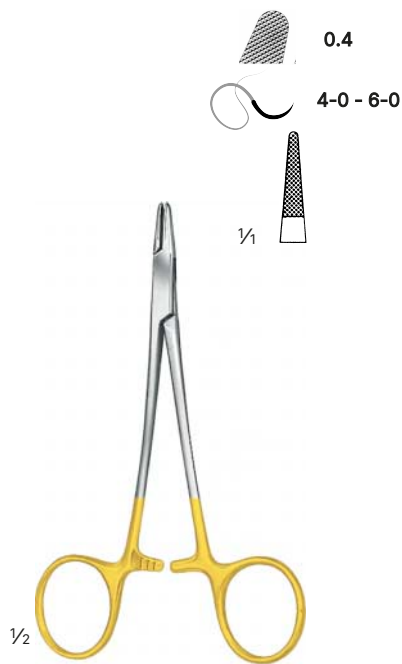

**Derf**

**PO 910-12**

12,5 cm / 4 7/8"

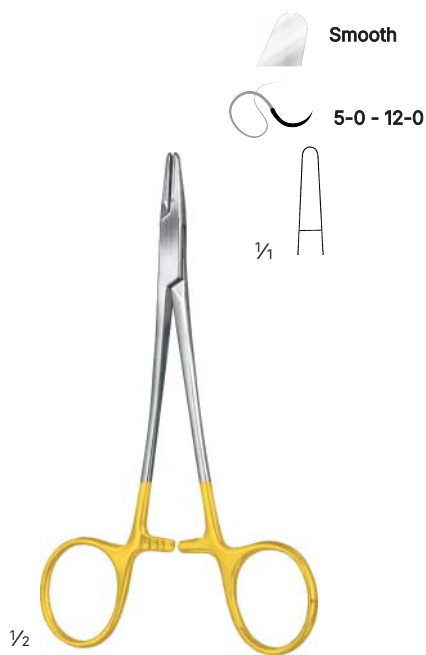

**Webster**

**PO 914-13**

13 cm / 5 1/8"

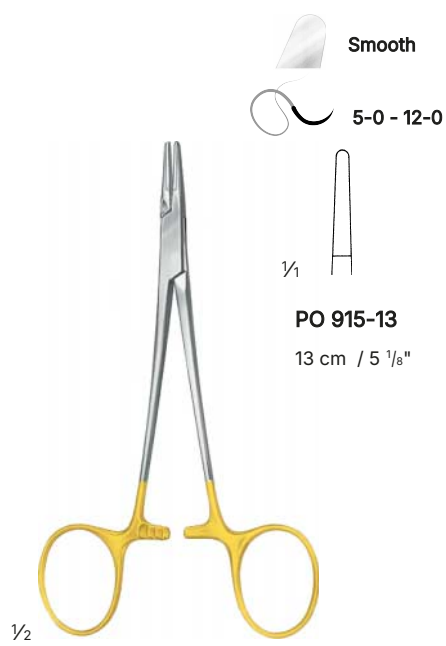

**PO 915-13**

13 cm / 5 1/8"

**Halsey**

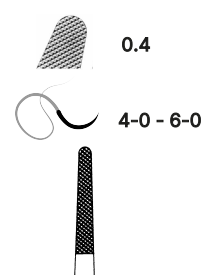

**PO 916-13**

13 cm / 5 1/8"

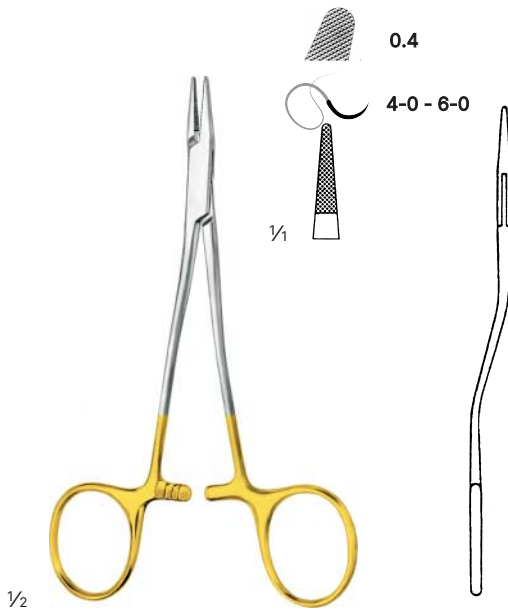

**Kilner**  
**PO 912-13**  
13,5 cm / 5 2/8"



**Hegar-Baumgartner**  
**PO 916-14**  
14 cm / 5 5/8"

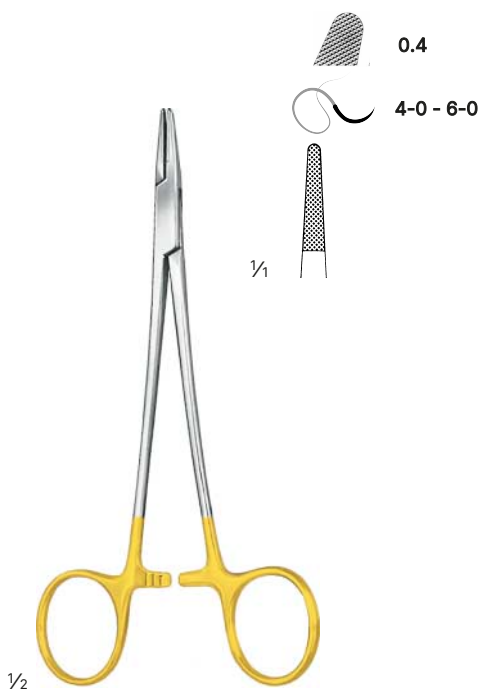

**Crile-Wood**  
**PO 919-15**  
15 cm / 5 7/8"

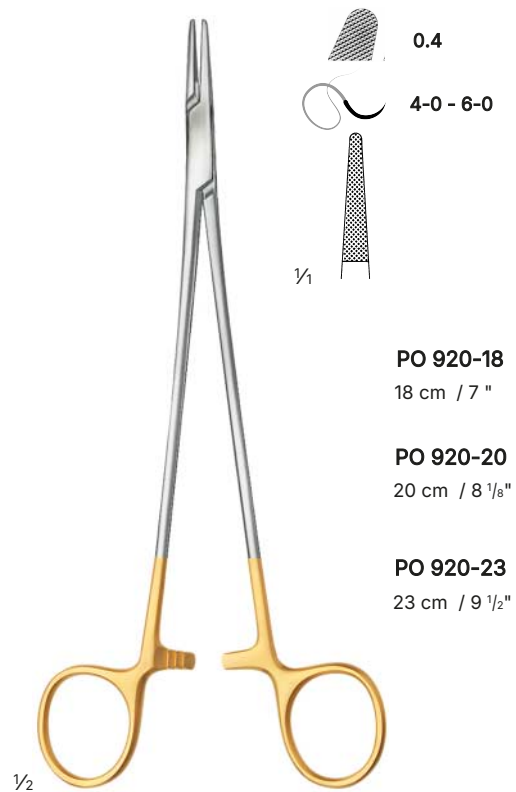

**Crile-Wood**

**PO 920-18**  
18 cm / 7"

**PO 920-20**  
20 cm / 8 1/8"

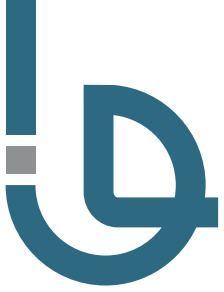

**PO 920-23**  
23 cm / 9 1/2"



# Needle Holders and Suture Instruments

## Needle Holders

 TC

  
4-0 and smaller  
  
0.5



1/2

Mayo-Hegar



**PO 900-16**  
16 cm / 6 2/8"



**PO 900-18**  
18 cm / 7 1/8"



**PO 900-20**  
20 cm / 7 7/8"

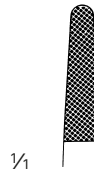



**PO 900-24**  
24 cm / 9 4/8"



**PO 900-26**  
26 cm / 10 2/8"



**PO 900-30**  
30 cm / 11 6/8"

  
6-0 and smaller  
  
0.4



1/2

DeBakey

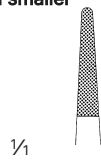

**PO 901-15**  
15 cm / 6"



**PO 901-18**  
18 cm / 7 1/8"



**PO 901-20**  
20,5 cm / 8 1/8"



**PO 901-23**  
23 cm / 9"



**PO 901-26**  
26,5 cm / 10 3/8"



**PO 901-31**  
31 cm / 12 2/8"

 TC



6-0 and smaller

0.4

1/4



**PO 902-13**  
13 cm / 5 1/8"



**PO 902-15**  
15 cm / 5 7/8"



**PO 902-18**  
18 cm / 7 1/8"

1/4

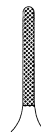

**PO 902-20**  
20 cm / 7 7/8"



**PO 902-23**  
23 cm / 9"



**PO 902-26**  
26 cm / 10 2/8"

1/2



Ryder



## Needle Holders and Suture Instruments

Needle Holders

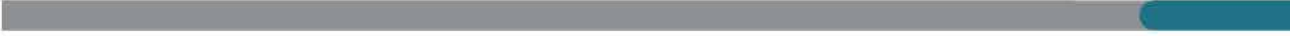

# Spreading Instruments

Skin Hooks  
Saddle Retractors  
Rake Retractors  
Thumb Retractors  
Double Ended Retractors  
Bone Retractors  
Lung Spatulas  
Scapula Retractors  
Pelvis Retractors  
Abdominal Retractors  
Abdominal Spatulas  
Mammoplasty Retractors  
Self Retaining Wound Retractor  
Self Retaining Abdominal Retractor  
Retractor Blades  
Self Retaining Abdominal Retractor Frames  
OR Table Mounted Retractor System

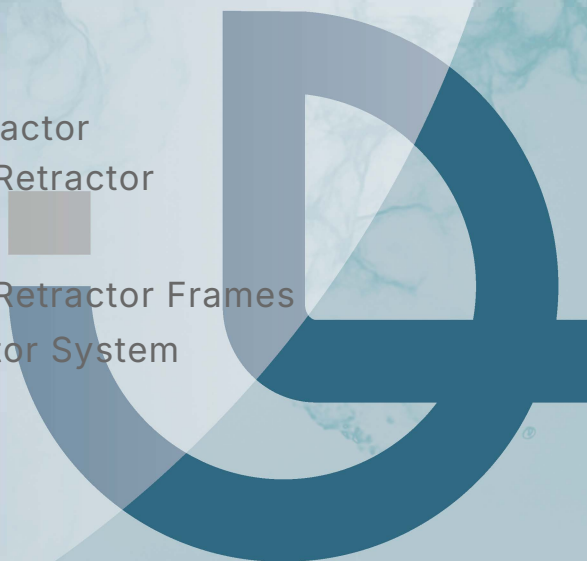



## Spreading Instruments

Nasal Hooks, Nasal Retractors



**Freer**  
**EK 130-15**  
15 cm / 5 7/8"  
sharp

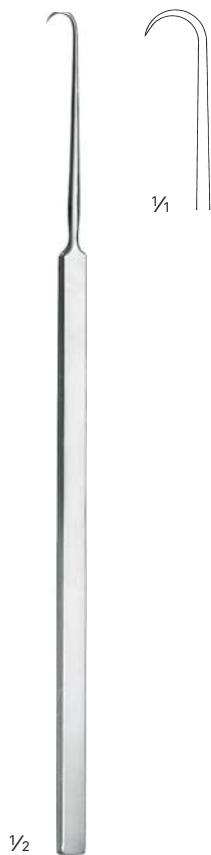

**Simon**  
**EK 140-01**  
21,5 cm / 8 4/8"

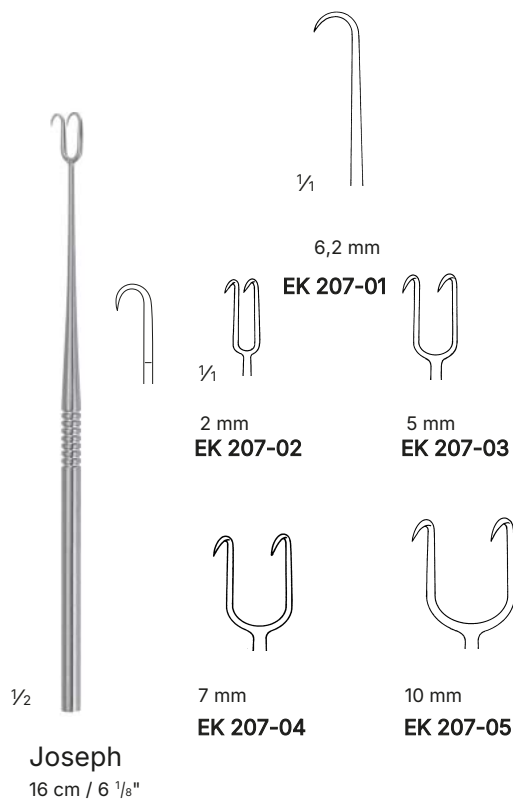

**Joseph**  
16 cm / 6 1/8"

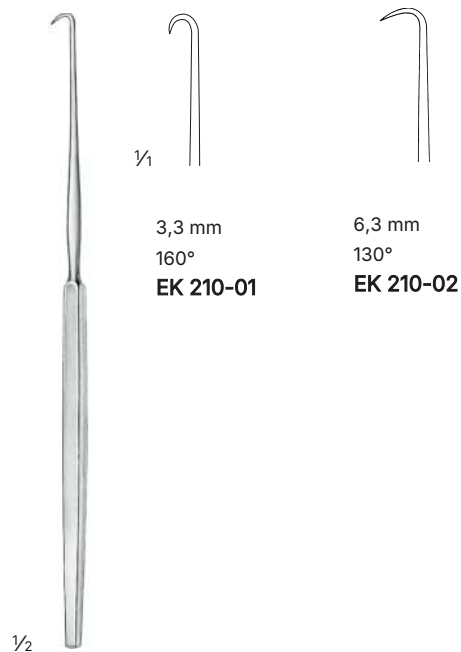

**Cottle**  
17 cm / 6 1/8"  
sharp



1/4

Ø 1,0 mm  
90°  
Fig. 1  
**HO 208-01**  
19 cm / 7<sup>4</sup>/<sub>8</sub>"

Ø 1,0 mm  
90°  
Fig. 1  
**HO 207-01**  
28 cm / 11"



1/4

Ø 1,6 mm  
90°  
Fig. 2  
**HO 208-02**  
19 cm / 7<sup>4</sup>/<sub>8</sub>"

Ø 1,6 mm  
90°  
Fig. 2  
**HO 207-02**  
28 cm / 11"

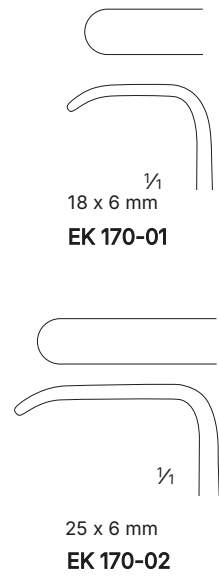

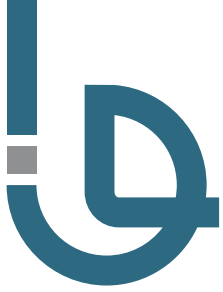

## Spreading Instruments

Nerve Root Retractors



1/2

**Love**

**EK 800-21**

21 cm / 8 4/8"

4 mm



1/2

**Caspar**

24 cm / 9 4/8"

**EK 801-06**

6 mm

**EK 801-08**

8 mm

**EK 801-10**

10 mm



1/2

**Cloward**

18 cm / 7 1/8"

**EK 803-01**

18 mm

**EK 803-02**

20 mm

**EK 803-03**

23 mm



$\frac{1}{2}$   
Love  
EK 801-06  
19 cm / 7  $\frac{4}{8}$ "



45°  
 $\frac{1}{2}$   
Love  
EK 801-08  
16 cm / 6  $\frac{2}{8}$ "



90°  
 $\frac{1}{2}$   
Love  
EK 801-10  
10 cm / 4"

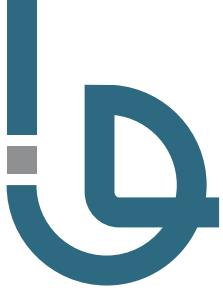

## Spreading Instruments

Hooks, Rake Retractors



1/2

16,5 cm / 6 4/8"



1/1

sharp



**EK 203-01**



**EK 203-02**

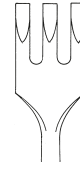

**EK 203-03**

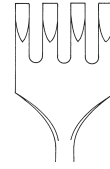

**EK 203-04**



1/1

blunt



**EK 204-01**



**EK 204-02**

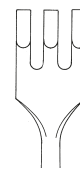

**EK 204-03**

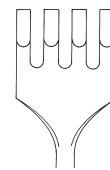

**EK 204-04**



1/4

Fig. 2  
**EK 214-10**  
10 x 6 mm

Fig. 1  
**EK 214-20**  
20 x 6 mm

1/2

**Senn-Green**  
16 cm / 6 2/8"



1/4

**EK 215-10**  
12 x 6 mm

**EK 215-17**  
18 x 6 mm

**EK 215-20**  
20 x 6 mm

**EK 215-22**  
21 x 8 mm

1/2

**Langenbeck-Mini**  
16 cm / 6 2/8"



1/2

**Desmarres**  
16 cm / 6 2/8"

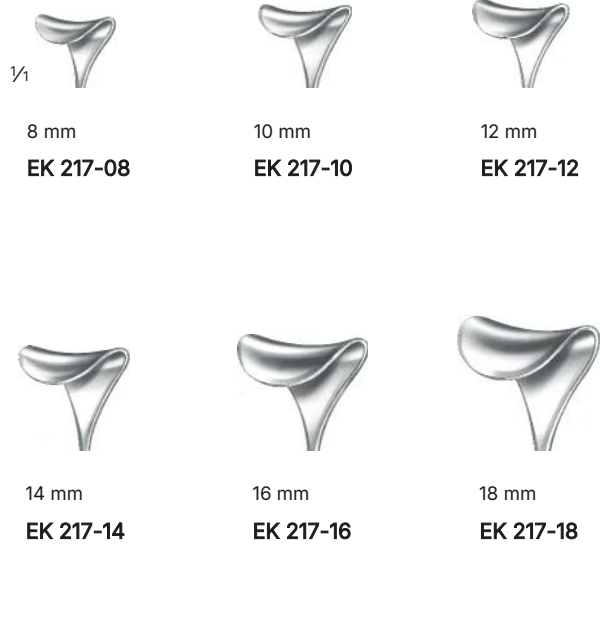

1/4

8 mm  
**EK 217-08**

10 mm  
**EK 217-10**

12 mm  
**EK 217-12**

14 mm  
**EK 217-14**

16 mm  
**EK 217-16**

18 mm  
**EK 217-18**



## Spreading Instruments

### Saddle Retractors



1/2  
**Cushing**  
20,5 cm / 8 1/8"

1/2  
**Cushing**  
24 cm / 9 4/8"

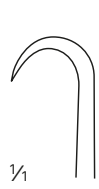

sharp

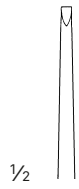

9 mm



9 x 8 mm



9 x 13 mm

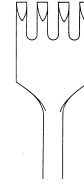

9 x 19 mm

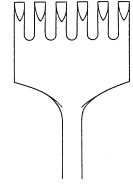

9 x 29 mm

**EK 229-01**

**EK 229-02**

**EK 229-03**

**EK 229-04**

**EK 229-06**

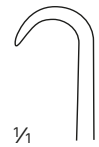

semi-sharp

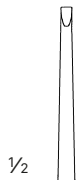

8.5 mm



8.5 x 8 mm



8.5 x 13 mm

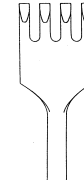

8.5 x 19 mm

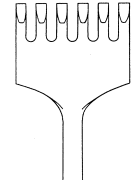

8.5 x 29 mm

**EK 230-01**

**EK 230-02**

**EK 230-03**

**EK 230-04**

**EK 230-06**

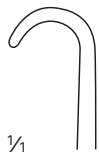

blunt

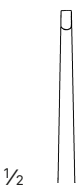

8 mm



8 x 8 mm



8 x 13 mm

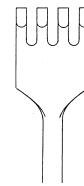

8 x 19 mm

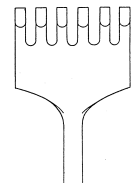

8 x 29 mm

**EK 231-01**

**EK 231-02**

**EK 231-03**

**EK 231-04**

**EK 231-06**



1/2

**Volkman**  
22,5 cm / 8 7/8"



## Spreading Instruments

Retractors



1/2

**Langenbeck**

22 cm / 8 5/8"

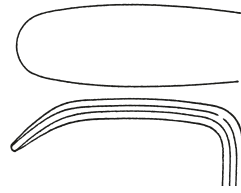

30 x 11 mm

**EK 353-01**

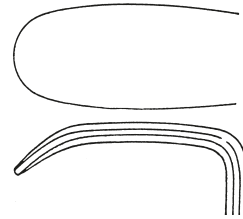

30 x 14 mm

**EK 353-02**

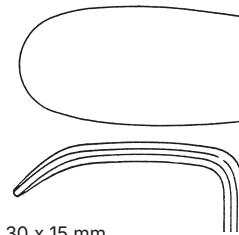

30 x 15 mm

**EK 353-03**

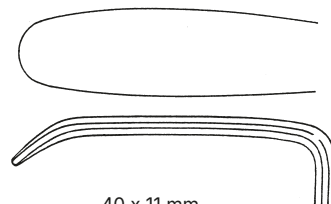

40 x 11 mm

**EK 353-04**

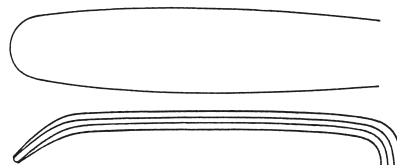

50 x 11 mm

**EK 353-05**

1/1



1/2

**Kocher-Langenbeck**

21,5 cm / 8 4/8"

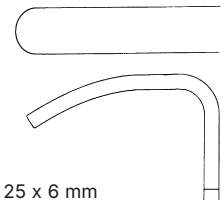

25 x 6 mm  
**EK 355-01**

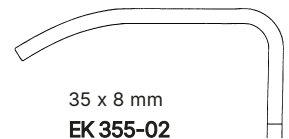

35 x 8 mm  
**EK 355-02**

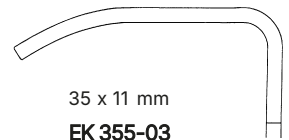

35 x 11 mm  
**EK 355-03**

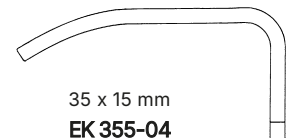

35 x 15 mm  
**EK 355-04**

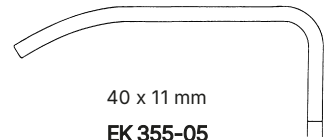

40 x 11 mm  
**EK 355-05**

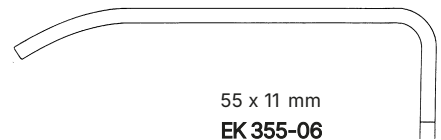

55 x 11 mm  
**EK 355-06**

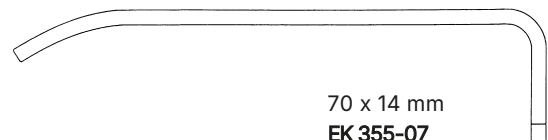

70 x 14 mm  
**EK 355-07**

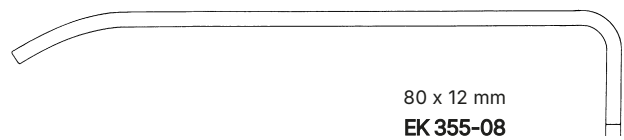

80 x 12 mm  
**EK 355-08**

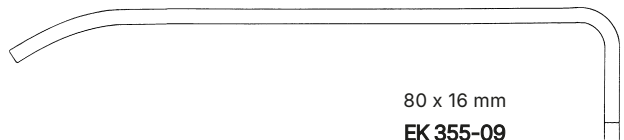

80 x 16 mm  
**EK 355-09**

1/4



## Spreading Instruments

Double Ended Retractors, Spatulas



1/2

Roux

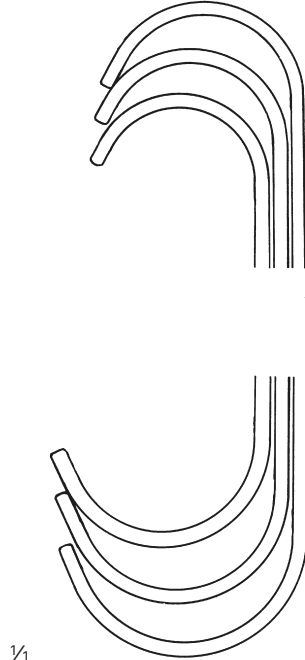

1/1

Fig.1 - 3  
**EK 396-00**  
17 cm / 6 5/8"  
Set

Fig.1  
22 x 21 mm  
27 x 29 mm  
**EK 396-01**  
14,5 cm / 5 7/8"

Fig.2  
25 x 26 mm  
30 x 38 mm  
**EK 396-02**  
16 cm / 6 2/8"

Fig.3  
28 x 29 mm  
33 x 43 mm  
**EK 396-03**  
17 cm / 6 5/8"



1/2

very soft maleable

**EK 550-12**  
20 cm / 7 7/8"  
6,5 mm

**EK 550-17**  
20 cm / 7 7/8"  
9,5 mm

**EK 550-20**  
20 cm / 7 7/8"  
13 mm

**EK 550-25**  
20 cm / 7 7/8"  
16 mm

**EK 551-25**  
20 cm / 7 7/8"  
25 mm



1/2

Finsen

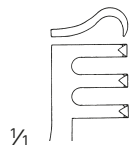

1/4

**EK 420-05**

5 cm / 2" sharp



16 mm

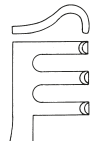

**EK 421-05**

5 cm / 2" blunt



16 mm

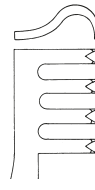

**EK 420-07**

7 cm / 2 6/8" sharp



20 mm

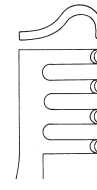

**EK 421-07**

7 cm / 2 6/8" blunt



20 mm



1/2

Alm

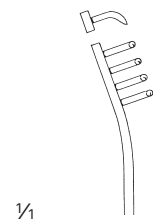

1/4

**EK 424-07**

7 cm / 2 6/8" sharp



55 mm

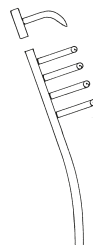

**EK 424-10**

10 cm / 3 7/8" sharp



70 mm



**EK 425-07**

7 cm / 2 6/8" blunt



55 mm



**EK 425-10**

10 cm / 3 7/8" blunt



70 mm



1/2

Jansen

10 cm / 3 7/8"

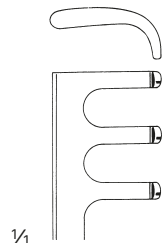

1/4

**EK 428-01**

blunt



47 mm

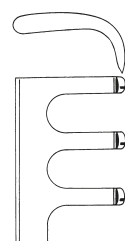

**EK 428-02**

sharp



47 mm

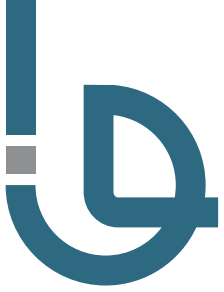

## Spreading Instruments

Self-Retaining Wound Retractors

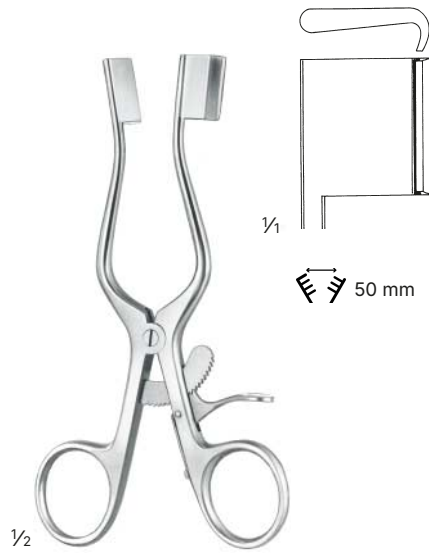

**Weitlaner-Baby**

**EK 432-14**

13,5 cm / 5 3/8"



**Weitlaner**

13,5 cm / 5 3/8"

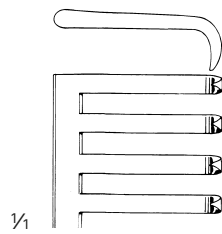

**EK 433-13**

sharp

 3x4

 43 mm

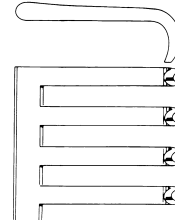

**EK 434-13**

blunt

 3x4

 43 mm



1/2

Weitlaner  
11 cm / 4 3/8"

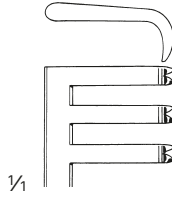

1/1

**EK 435-10**

sharp

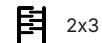

2x3

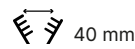

40 mm

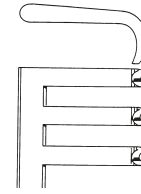

**EK 436-10**

blunt



2x3

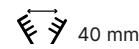

40 mm



1/2

Weitlaner

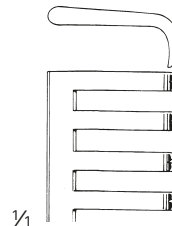

1/1

**EK 435-13**

13,5 cm / 5 3/8"

sharp



3x4



43 mm

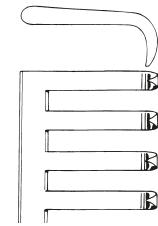

**EK 435-16**

16 cm / 6 2/8"

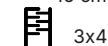

3x4

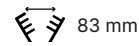

83 mm

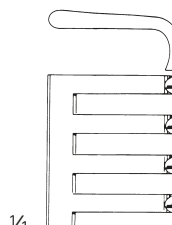

1/1

**EK 436-13**

13,5 cm / 5 3/8"

blunt

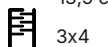

3x4



43 mm

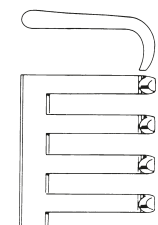

**EK 436-16**

16 cm / 6 2/8"

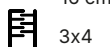

3x4



83 mm



## Spreading Instruments

Self-Retaining Wound Retractors



1/2

Weitlaner

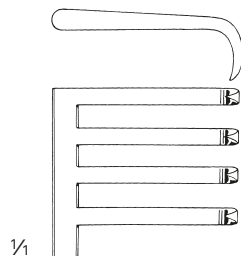

1/4

**EK 435-20**

20 cm / 7 7/8"

sharp



3x4



90 mm

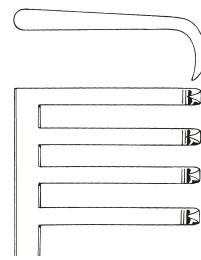

**EK 435-25**

24 cm / 9 4/8"

3x4

90 mm

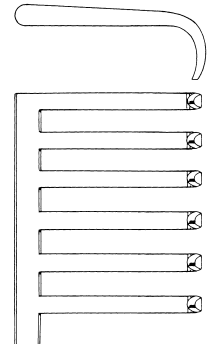

**EK 435-26**

25,5 cm / 10"

5x6

90 mm

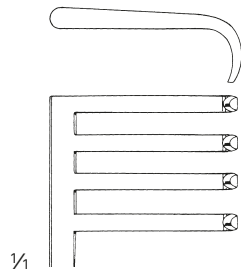

1/4

**EK 436-20**

20 cm / 7 7/8"

blunt



3x4



90 mm

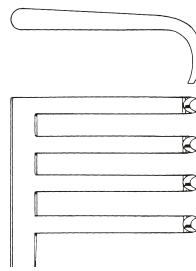

**EK 436-25**

24 cm / 9 4/8"

3x4

90 mm

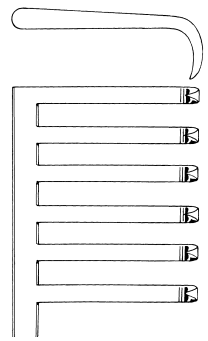

**EK 436-26**

25,5 cm / 10"

5x6

90 mm

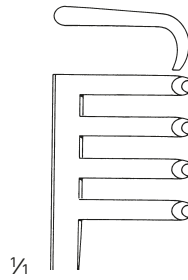

**EK 438-00**

blunt

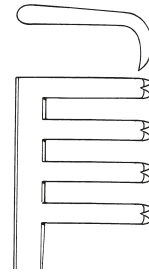

**EK 437-00**

sharp



**Henley**  
**EK 437-00**  
**EK 438-00**

16,5 cm / 6 5/8"



complete with 3 central blades  
ref. EK 437-19, EK 437-25 and  
EK 437-32



**EK 437-19**

19 x 17 mm



**EK 437-25**

25 x 17 mm



**EK 437-32**

32 x 17 mm

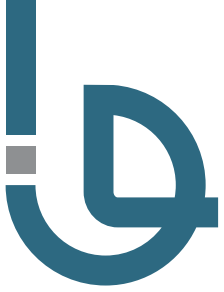

## Spreading Instruments

Self-Retaining Wound Retractors



**Milligan**  
**EK 440-13**  
13,5 cm / 5 3/8"

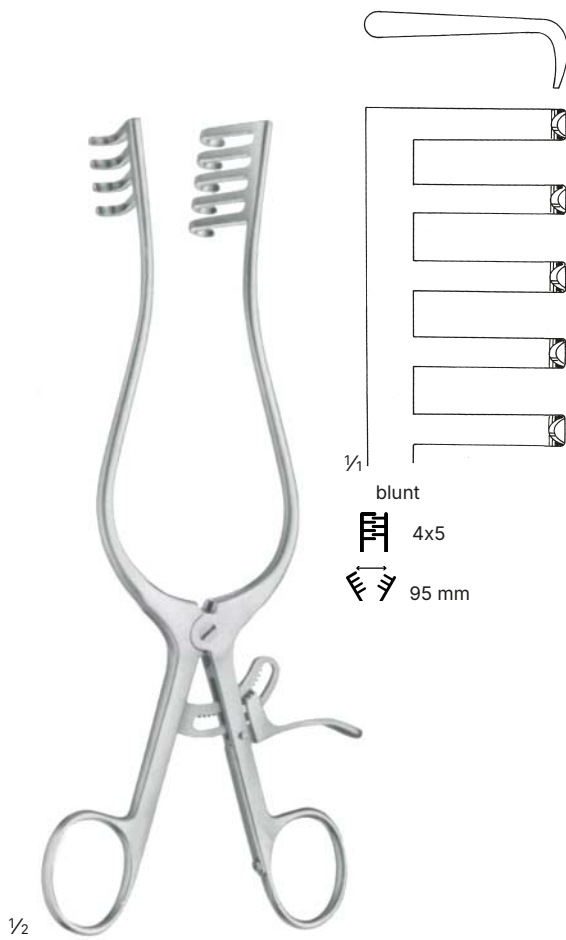
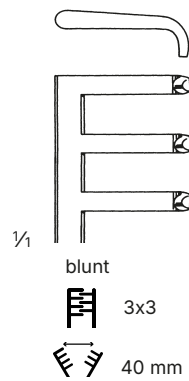

**Travers**  
**EK 441-21**  
21 cm / 8 1/8"

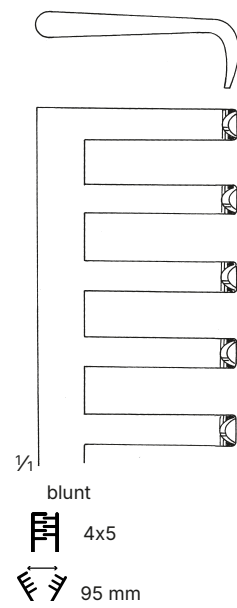



1/2

**Weitlaner-Wullstein**  
13 cm / 5 1/8"

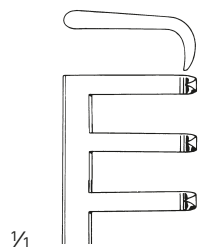

1/1

**EK 444-13**

sharp

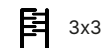

40 mm

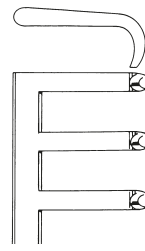

**EK 445-13**

blunt

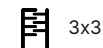

40 mm



1/2

**Mollison**  
**EK 446-15**  
15,5 cm / 6 1/8"

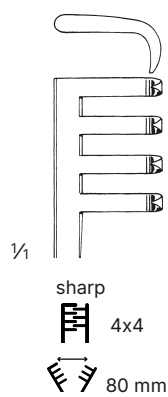

1/1

sharp



80 mm



1/2

**Anderson-Adson**  
**EK 452-20**  
19 cm / 7 4/8"

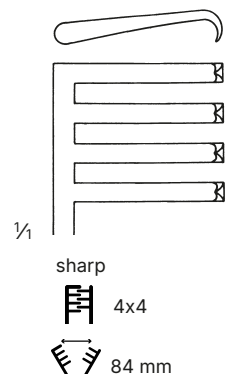

1/1

sharp

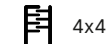

84 mm

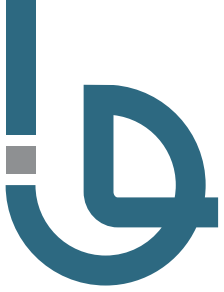

## Spreading Instruments

Self-Retaining Wound Retractors

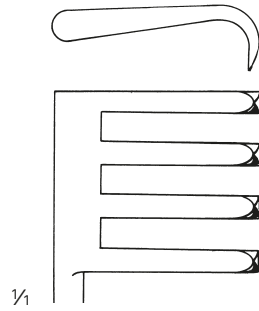

**EK 454-27**

26 cm / 10 <sup>2</sup>/<sub>8</sub>"

sharp

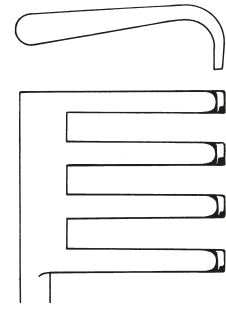

**EK 455-27**

26 cm / 10 <sup>2</sup>/<sub>8</sub>"

blunt

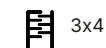

1/2

Adson

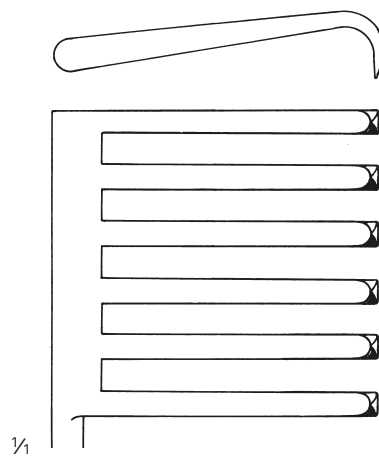

**EK 456-27**

29 cm / 11 <sup>3</sup>/<sub>8</sub>"

sharp

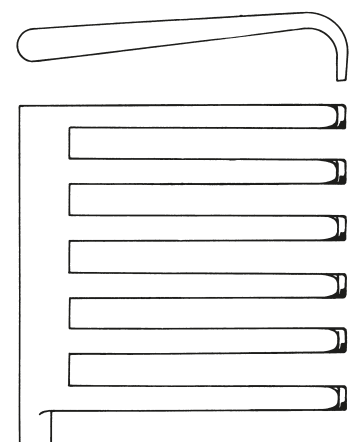

**EK 457-27**

29 cm / 11 <sup>3</sup>/<sub>8</sub>"

blunt



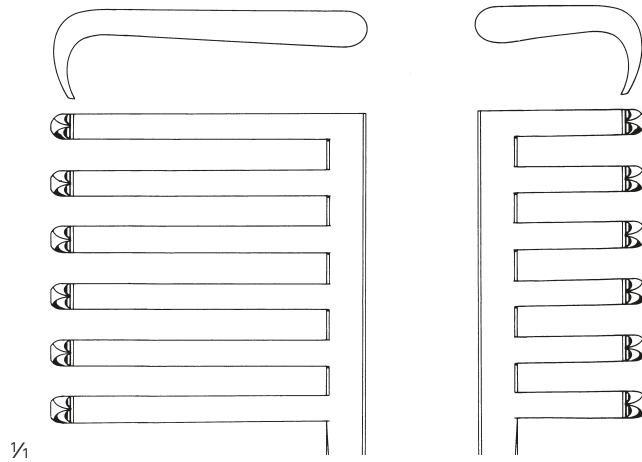

**EK 457-01**  
sharp, long teeth on left side



6x6



145 mm

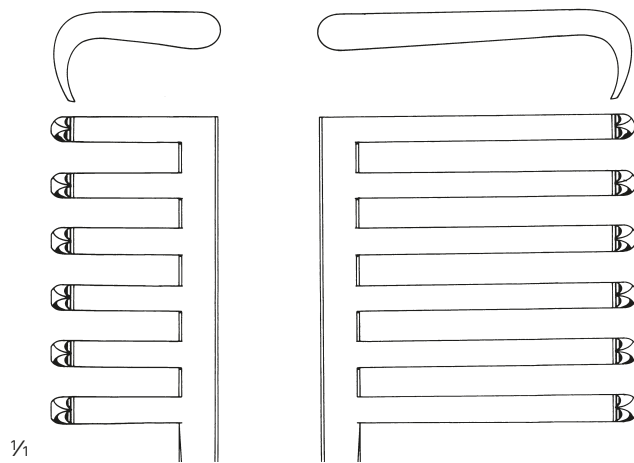

**EK 457-02**  
sharp, long teeth on right side

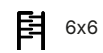

6x6



145 mm



**Adson**  
28,5 cm / 11 2/8"

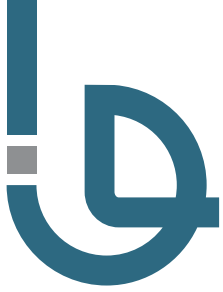

## Spreading Instruments

Self-Retaining Wound Retractors

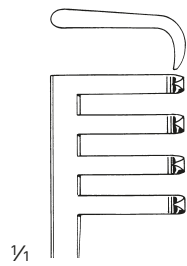

1/1

**EK 458-13**  
14 cm / 5 4/8"

sharp



3x4  
81 mm

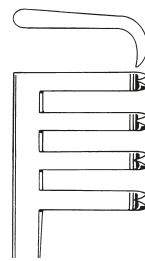

**EK 458-16**  
16,5 cm / 6 4/8"

3x4  
90 mm

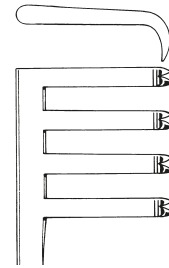

**EK 458-20**  
21 cm / 8 2/8"

3x4  
135 mm

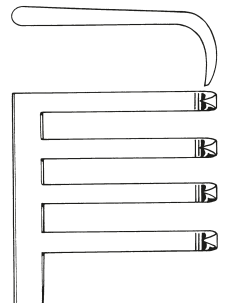

**EK 458-25**  
24,5 cm / 9 5/8"

3x4  
135 mm

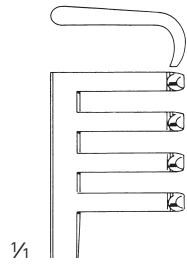

1/1

**EK 459-13**  
14 cm / 5 4/8"

blunt



3x4  
81 mm

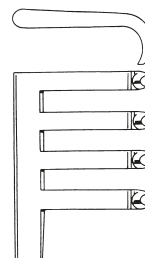

**EK 459-16**  
16,5 cm / 6 4/8"

3x4  
90 mm

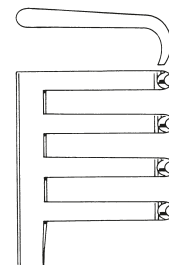

**EK 459-20**  
21 cm / 8 2/8"

3x4  
135 mm

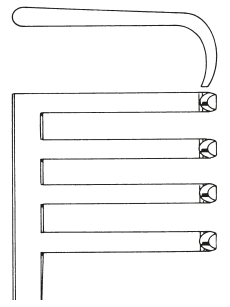

**EK 459-25**  
24,5 cm / 9 5/8"

3x4  
135 mm



Beckmann  
EK 460-31  
32 cm / 12 5/8"  
sharp

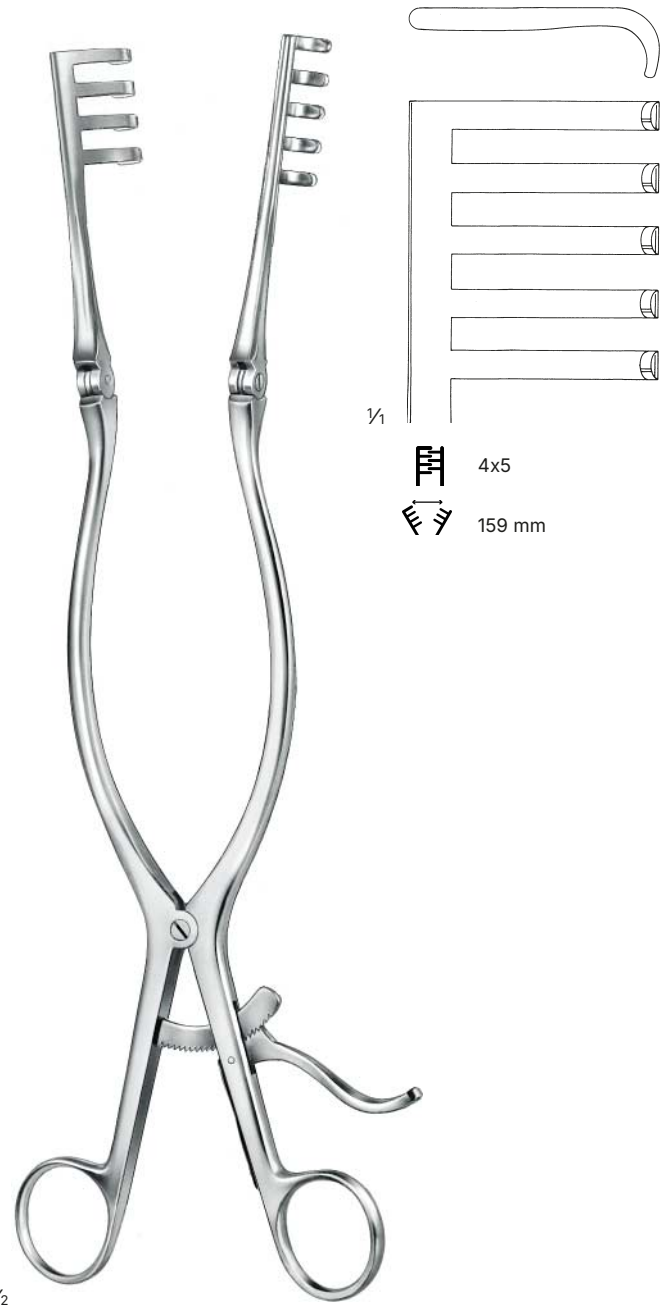

Beckmann  
EK 463-33  
33 cm / 13 "  
blunt

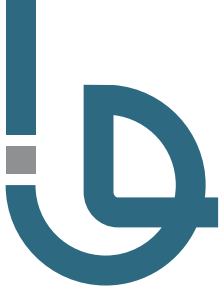

## Spreading Instruments

Self-Retaining Wound Retractors



1/2

Beckman-Adson

 142 mm

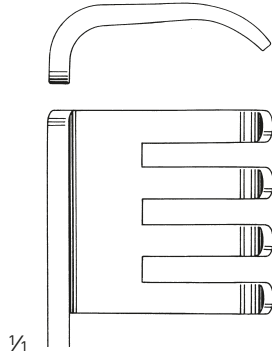

1/4

**EK 464-01**

31 cm / 12 2/8"

blunt

 4x4

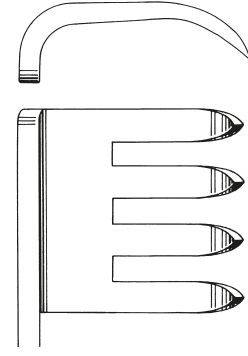

**EK 464-02**

31 cm / 12 2/8"

sharp

 4x4

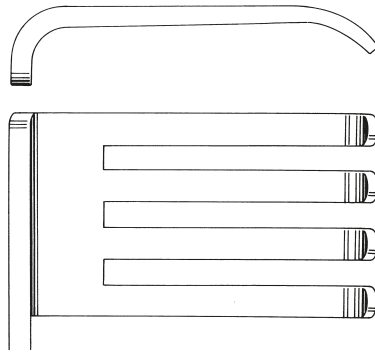

**EK 464-03**

31 cm / 12 2/8"

blunt

 4x4

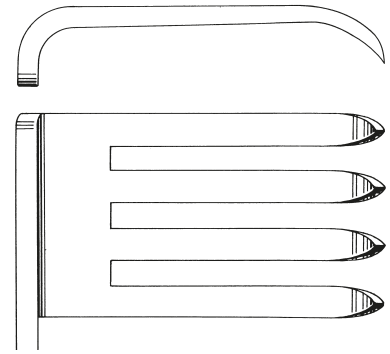

**EK 464-04**

31 cm / 12 2/8"

sharp

 4x4



1/2

Beckman-Eaton

**EK 466-33**

32 cm / 12 5/8"

sharp

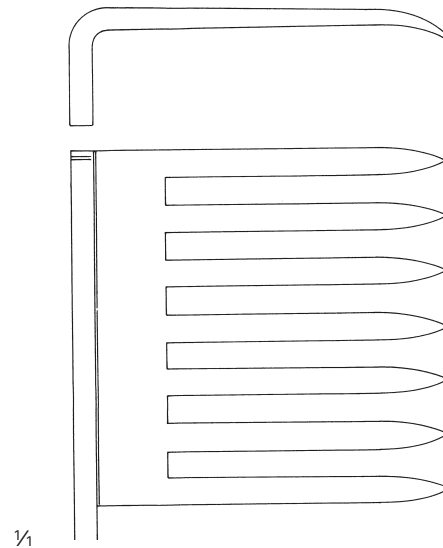

1/1

 7x7

 159 mm



## Spreading Instruments

Self-Retaining Wound Retractors

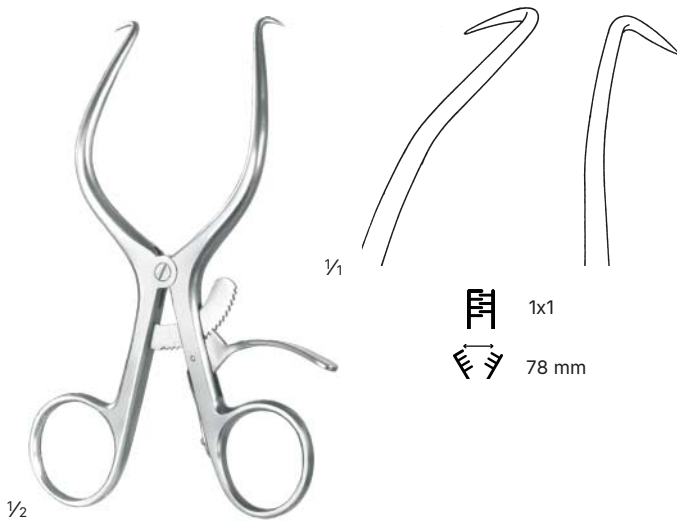

**Gelpi**  
**EK 469-14**  
13 cm / 5 1/8"

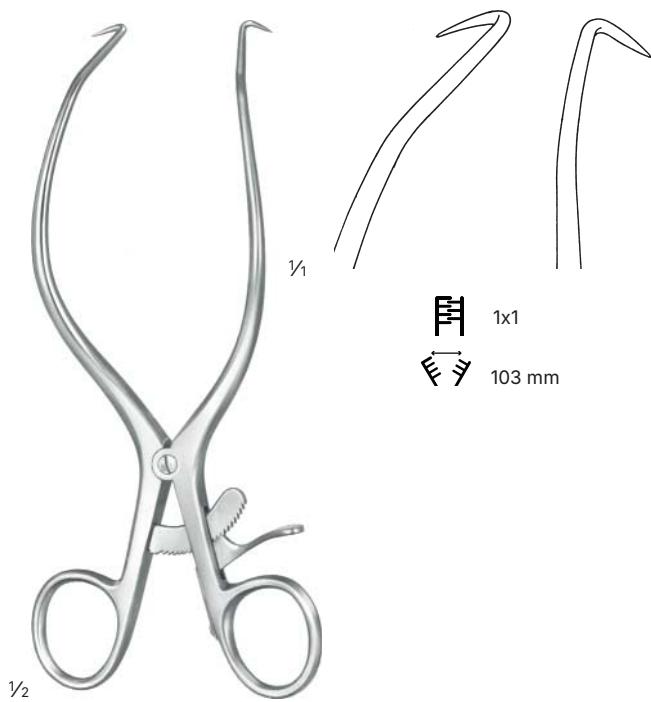

**Gelpi**  
**EK 469-19**  
18 cm / 7 1/8"

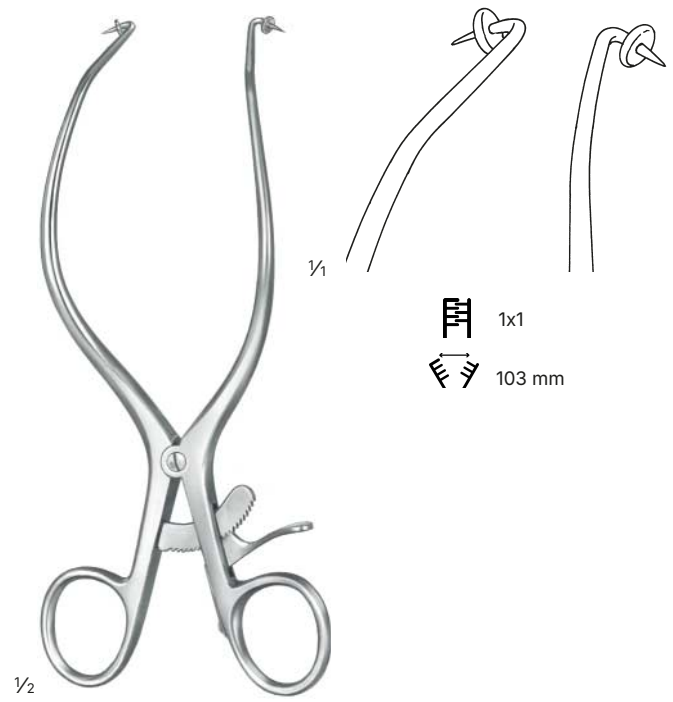

**Gelpi**  
**EK 470-19**  
18,5 cm / 7 2/8"

**EK 471-01**

50 x 10 mm  
Left blade

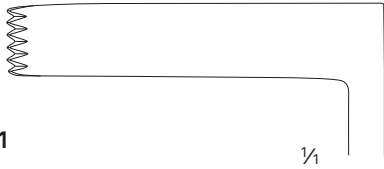

**EK 472-01**

50 x 10 mm  
Blade rightfull

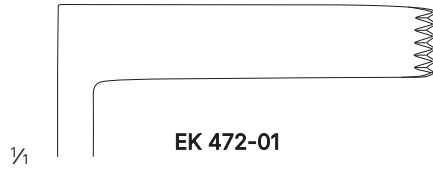

**EK 471-02**

60 x 10 mm  
Blade left full

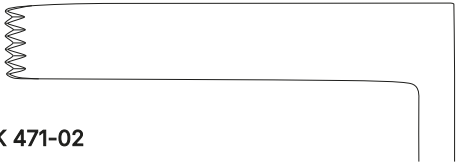

**EK 472-02**

60 x 10 mm  
Blade rightfull

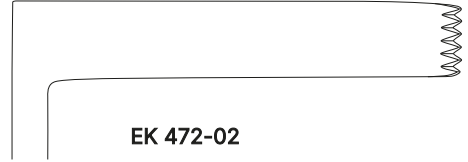

**EK 471-03**

70 x 10 mm  
Blade left full



**EK 472-03**

70 x 10 mm  
Blade rightfull

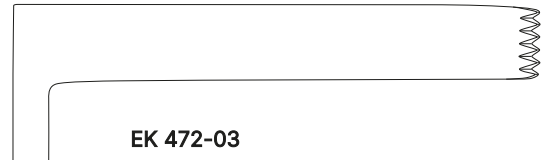

**Meyerding**

17 cm / 6 5/8"

 102 mm



## Spreading Instruments

Self-Retaining Wound Retractors



1/2

**Meyerding**

18 cm / 7 1/8"

- EK 474-01** 32 x 25 mm
- EK 474-02** 54 x 25 mm
- EK 474-03** 60 x 19 mm
- EK 474-04** 60 x 25 mm



1/2

**Plester**

13 cm / 5 1/8"

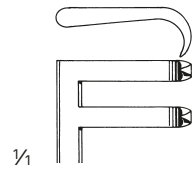

1/4

**EK 475-13**  
sharp

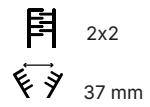

2x2

37 mm

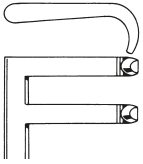

**EK 475-14**  
blunt

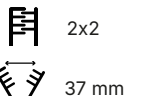

2x2

37 mm



1/2

**Plester**

**EK 476-10**

10,5 cm / 4 1/8"

blunt

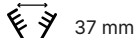

37 mm

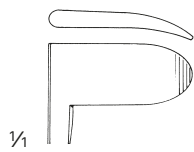

1/4



1/2

**Plester**

**EK 477-10**

10,5 cm / 4 1/8"

blunt



37 mm

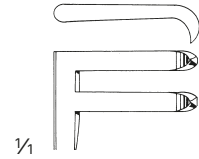

1/4

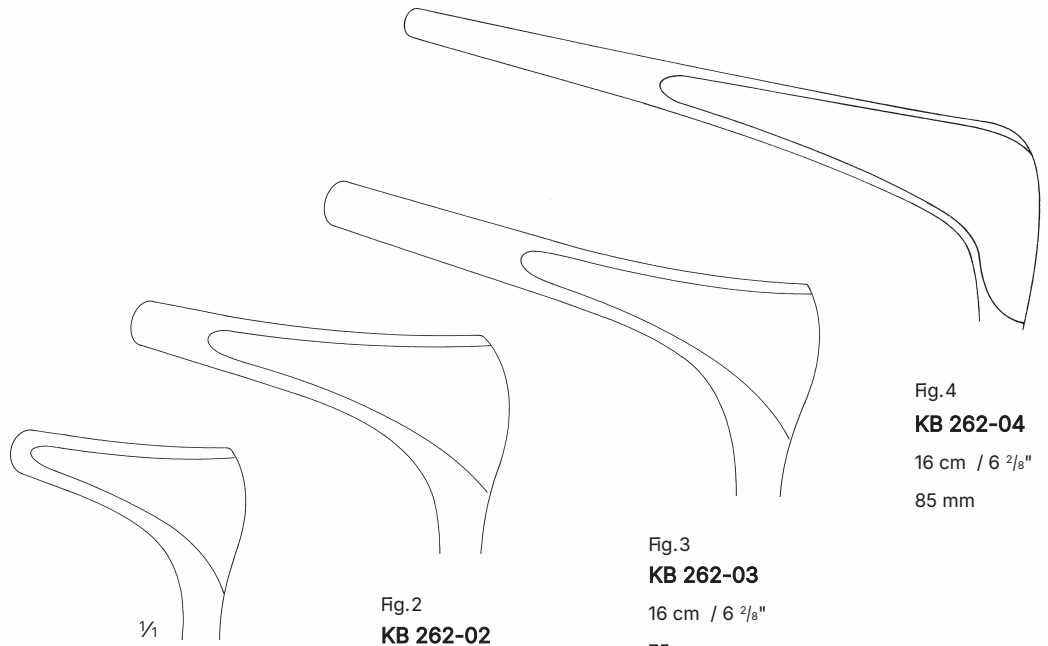

Fig.1  
**KB 262-01**  
13,5 cm / 5 <sup>3</sup>/<sub>8</sub>"  
35 mm

Fig.2  
**KB 262-02**  
14 cm / 5 <sup>4</sup>/<sub>8</sub>"  
50 mm

Fig.3  
**KB 262-03**  
16 cm / 6 <sup>2</sup>/<sub>8</sub>"  
75 mm

Fig.4  
**KB 262-04**  
16 cm / 6 <sup>2</sup>/<sub>8</sub>"  
85 mm



<sup>1</sup>/<sub>2</sub>  
Cottle

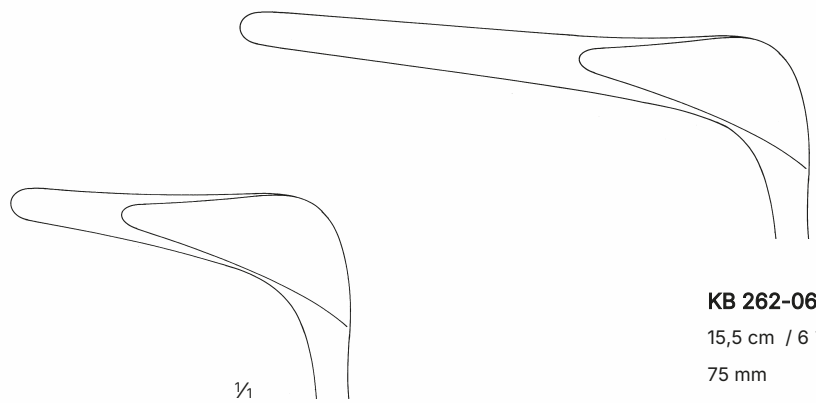

<sup>1</sup>/<sub>1</sub>  
**KB 262-05**  
14 cm / 5 <sup>4</sup>/<sub>8</sub>"  
45 mm

**KB 262-06**  
15,5 cm / 6 <sup>1</sup>/<sub>8</sub>"  
75 mm

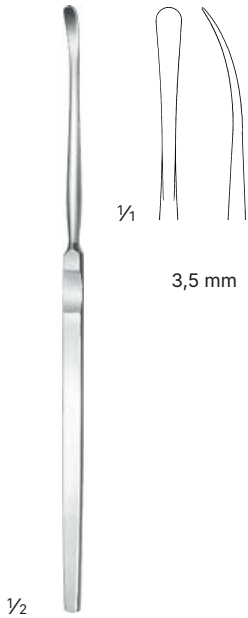

**Halle**  
**KB 350-18**  
16 cm / 6 2/8"

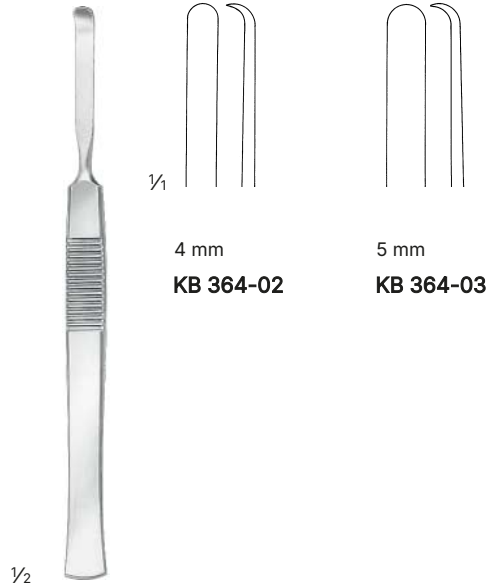

**McKenty**  
15 cm / 5 7/8"

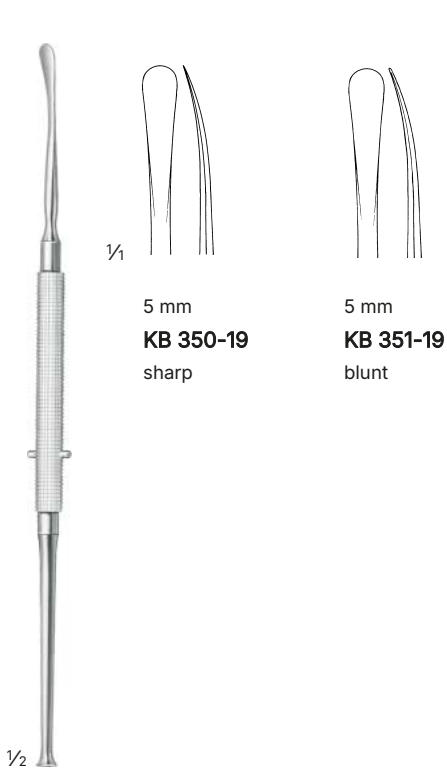

**Freer**  
19 cm / 7 4/8"

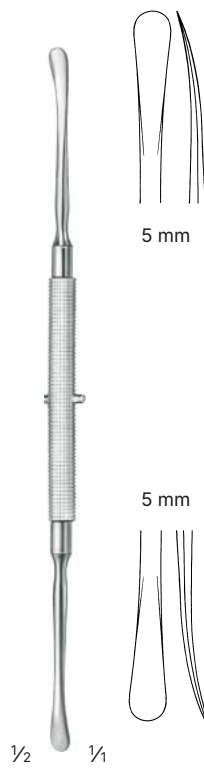

**Freer**  
**KB 353-18**  
18 cm / 7 1/8"

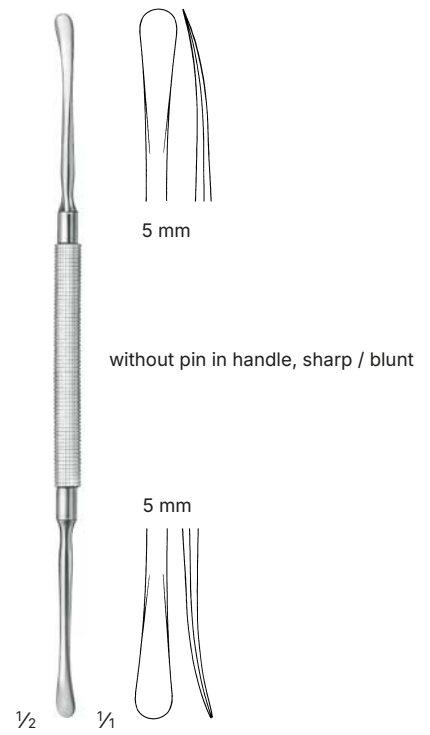

**Freer**  
**KB 354-18**  
18 cm / 7 1/8"

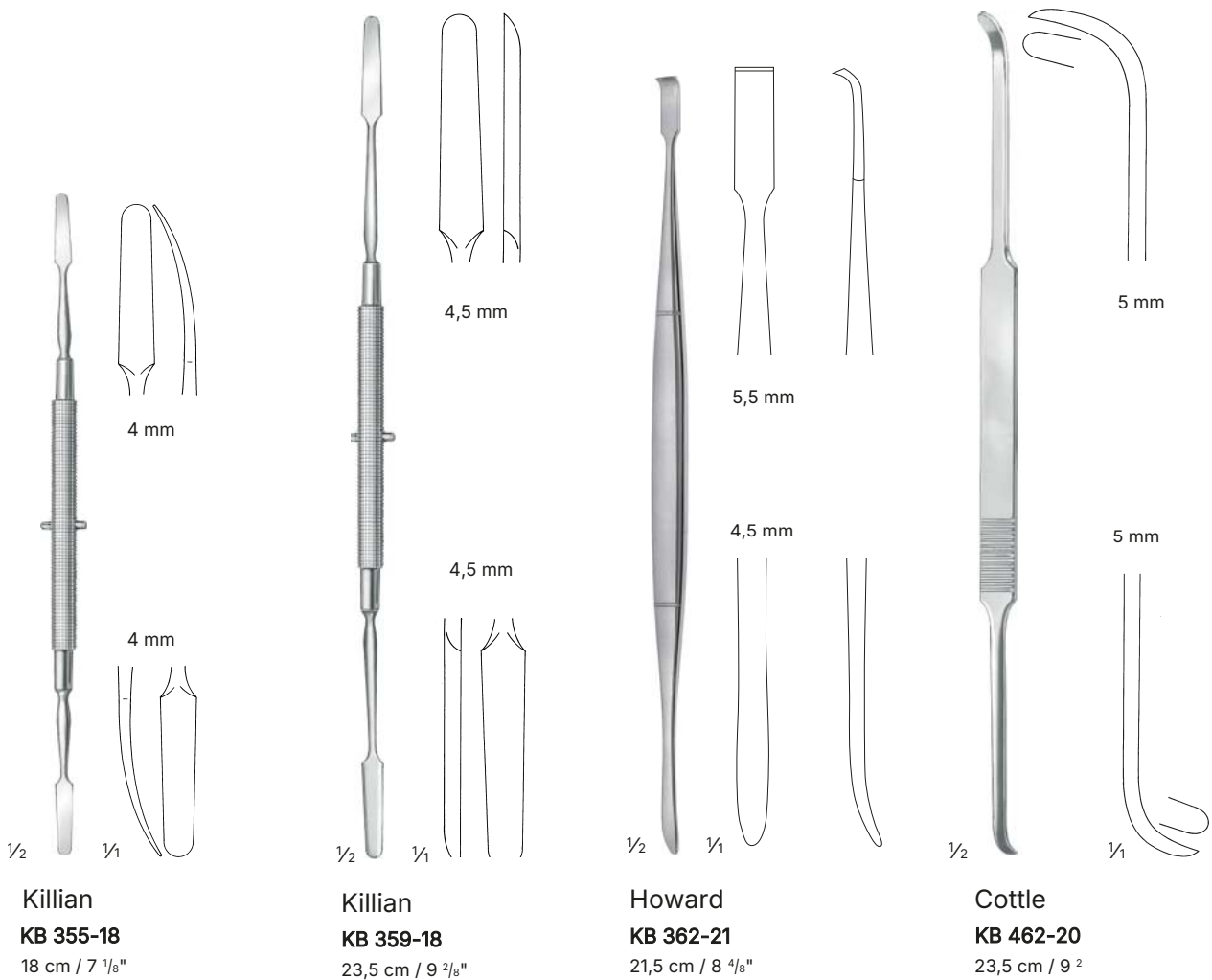

**Killian**  
**KB 355-18**  
 18 cm / 7 1/8"

**Killian**  
**KB 359-18**  
 23,5 cm / 9 2/8"

**Howard**  
**KB 362-21**  
 21,5 cm / 8 4/8"

**Cottle**  
**KB 462-20**  
 23,5 cm / 9 2"



**Davis**  
**KB 468-24**  
24,5 cm / 9 <sup>5</sup>/<sub>8</sub>"

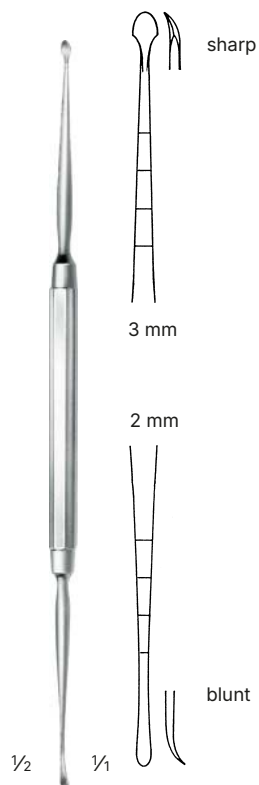

**Masing**  
**KB 460-20**  
19,5 cm / 7 <sup>5</sup>/<sub>8</sub>"

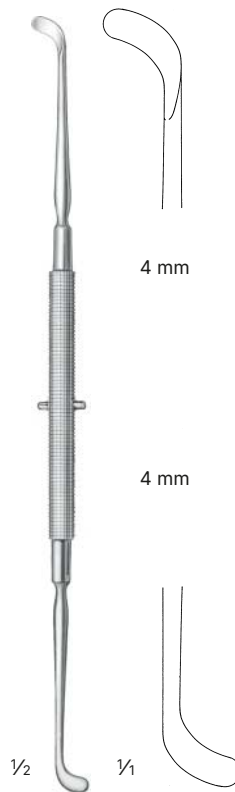

**Pennington**  
**KB 460-21**  
21,5 cm / 8 <sup>4</sup>/<sub>8</sub>"

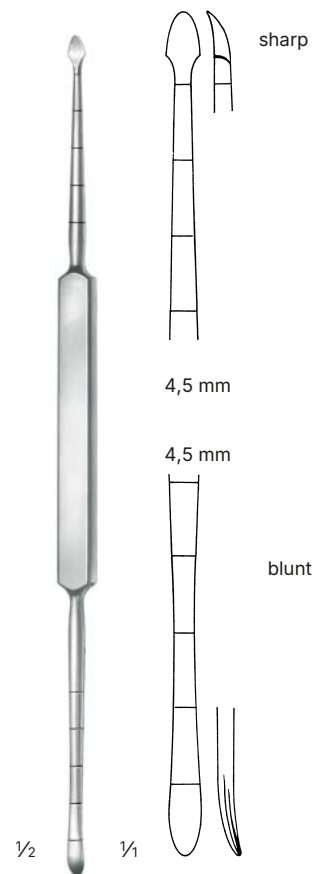

**Cottle**  
**KB 461-20**  
22 cm / 8 <sup>5</sup>/<sub>8</sub>"



**Freer**  
16,5 cm / 6 4/8"

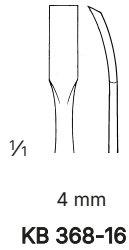

4 mm  
**KB 368-16**

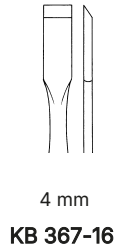

4 mm  
**KB 367-16**

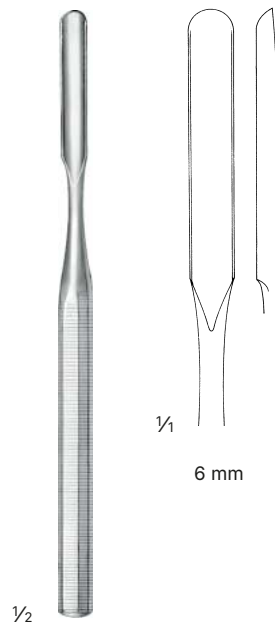

**Freer**  
**KB 420-15**  
16 cm / 6 2/8"

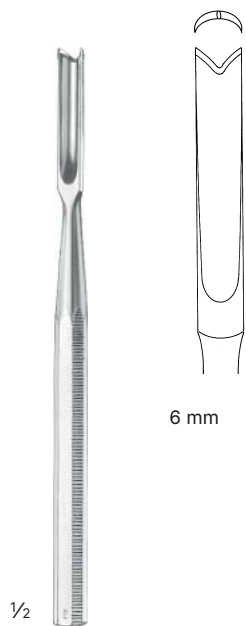
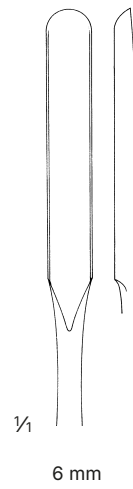

**Ballenger**  
**KB 421-15**  
15 cm / 5 7/8"



6 mm

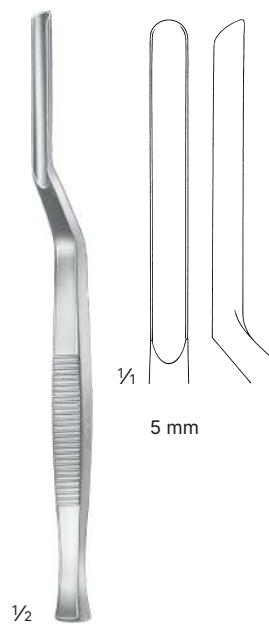

**Killian**  
**KB 423-17**  
16 cm / 6 2/8"

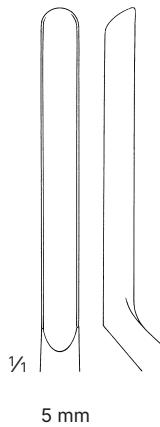

5 mm

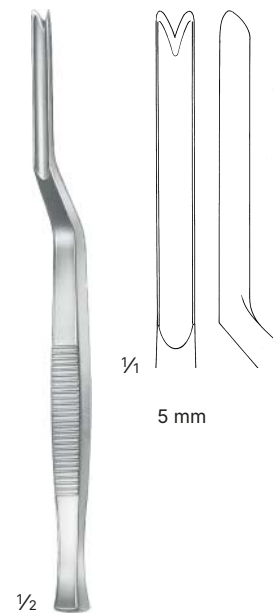

**Killian-Klaus**  
**KB 422-17**  
16 cm / 6 2/8"

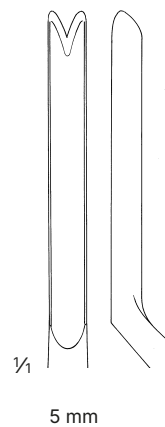

1/4

5 mm

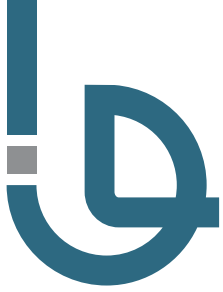

1/2

**Cottle**

18,5 cm / 7 2/8"

<b>KB 491-04</b>	4 mm
<b>KB 491-06</b>	6 mm
<b>KB 491-08</b>	7 mm
<b>KB 491-10</b>	9 mm
<b>KB 491-12</b>	12 mm



<b>KB 492-04</b>	4 mm
<b>KB 492-06</b>	6 mm
<b>KB 492-07</b>	7 mm
<b>KB 492-09</b>	9 mm
<b>KB 492-10</b>	10 mm
<b>KB 492-12</b>	12 mm



1/2

**Cottle**

**KB 493-06**  
18,5 cm / 7 2/8"



6 mm



1/2

**Cottle**

18,5 cm / 7 2/8"

<b>KB 503-02</b>	2 mm
<b>KB 503-04</b>	4 mm
<b>KB 503-06</b>	6 mm
<b>KB 503-08</b>	8 mm
<b>KB 503-10</b>	10 mm
<b>KB 503-12</b>	12 mm

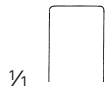

1/4



1/2

**Cottle**

**KB 504-16**  
18,5 cm / 7 2/8"

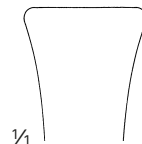

1/4

16 mm



1/2

**Rubin**

**KB 505-14**  
18,5 cm / 7 2/8"

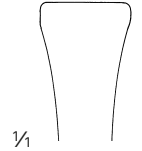

1/4

14 mm



1/2



1/4

3 mm  
KB 494-03

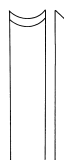

4,5 mm  
KB 494-05

Walter  
19 cm / 7 4/8"



1/2

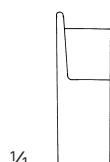

1/4

KB 499-04	4 mm
KB 499-05	5 mm
KB 499-06	6 mm
KB 499-08	7 mm

Fomon  
16 cm / 6 2/8"

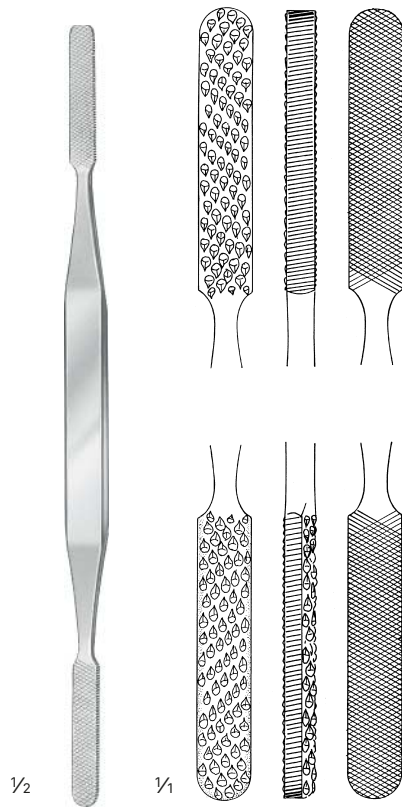
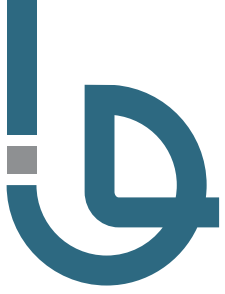

1/2

1/1

7 mm

Fomon

KB 505-21

20,5 cm / 8 1/8"

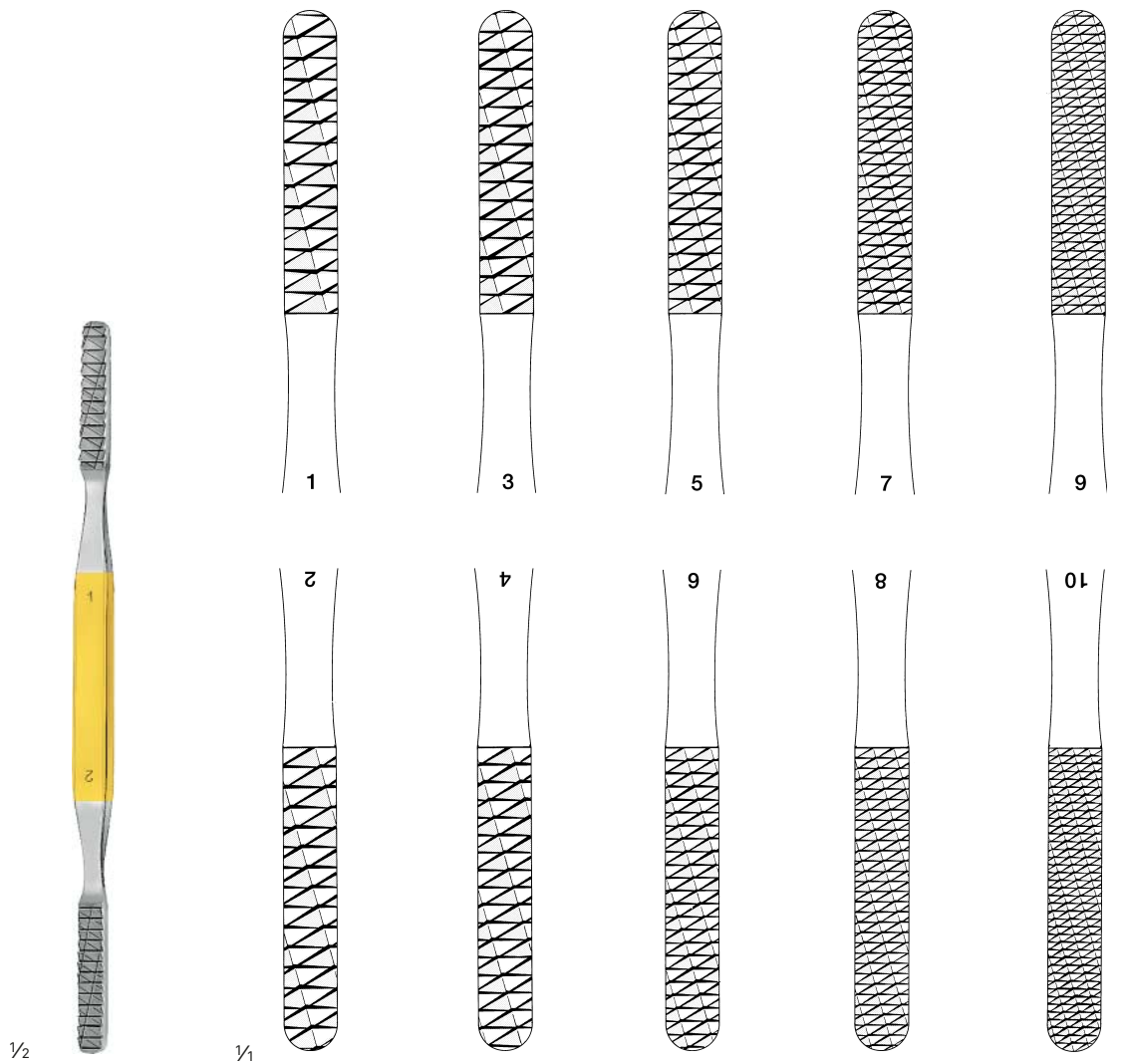

**Fomon**  
20,5 cm / 8 1/8"

Fig.1/2  
**KB 515-01**  
40 x 7 mm

Fig.3/4  
**KB 515-02**  
40 x 7 mm

Fig.5/6  
**KB 515-03**  
40 x 7 mm

Fig.7/8  
**KB 515-04**  
40 x 7 mm

Fig.9/10  
**KB 515-05**  
40 x 7 mm

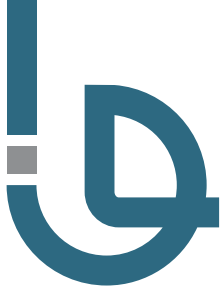

1/2

**Lewis**

19 cm / 7 4/8"

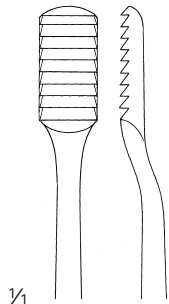

1/4

15 x 8 mm  
**KB 517-08**  
drawing cut  
delicate serration

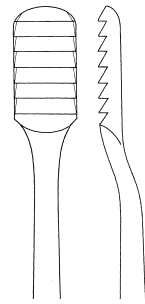

15 x 8 mm  
**KB 518-08**  
drawing cut  
coarse serration



1/2

**Aufricht**

21 cm / 8 2/8"

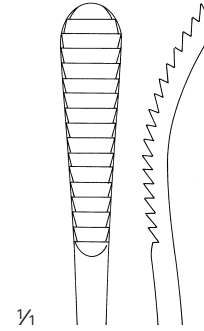

1/4

32 x 9 mm  
**KB 519-08**  
pushing cut

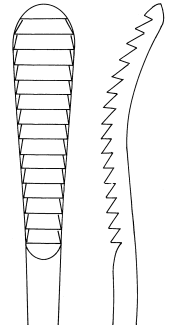

32 x 9 mm  
**KB 520-08**  
drawing cut

# Bone and Traumatology Instruments

Osteotoms  
Gouges  
Chisels  
Spongiosa Gouges  
Mallets  
Bone Curette  
Periosteal Raspatories  
Bone Files and Rasp  
Elevators  
Bone Levers  
Knee Retractors  
Spinal Retractors  
Meniscus and Cartilage Forceps  
Bone Reposition Forceps  
Bone Holding Forceps  
Bone Holding Clamps  
Bone Rongeurs  
Bone Cutting Forceps  
Wire Saws  
Hand Drills  
Screw Drivers  
Wire Traction Bows  
Wire Guides  
Bone Wires  
Wire Holders  
Flat Nose Pliers  
Wire Cutting Pliers  
Plaster Shears  
Plaster Spreaders





1/2

**Stille**  
20,5 cm / 8 1/8"

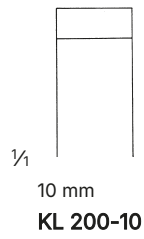

1/4

10 mm  
**KL 200-10**

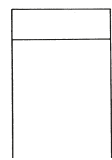

12 mm  
**KL 200-12**

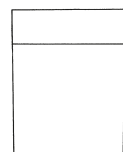

15 mm  
**KL 200-15**

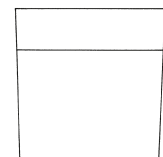

20 mm  
**KL 200-20**

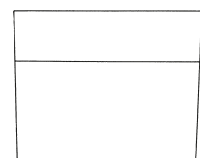

25 mm  
**KL 200-25**



1/2

**Stille**  
20,5 cm / 8 1/8"

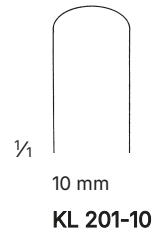

1/4

10 mm  
**KL 201-10**



12 mm  
**KL 201-12**

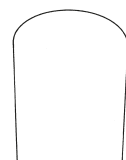

15 mm  
**KL 201-15**

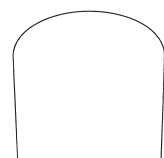

20 mm  
**KL 201-20**

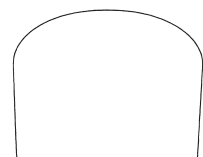

25 mm  
**KL 201-25**

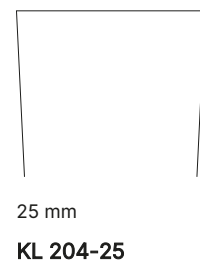
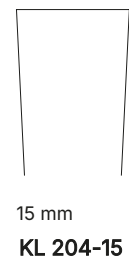
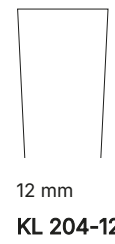
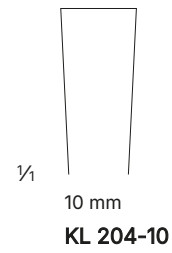
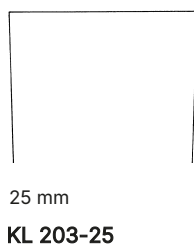
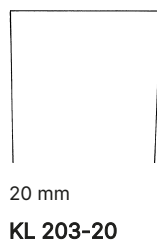
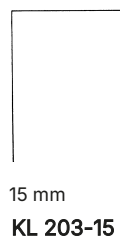
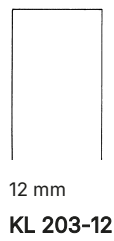
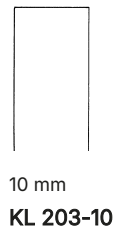
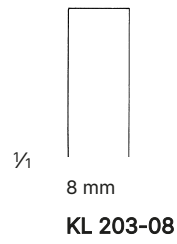

**Stille**  
20,5 cm / 8 1/8"



**Stille**  
20,5 cm / 8 1/8"  
delicate



2 mm  
**KB 498-02**



3 mm  
**KB 498-03**



4 mm  
**KB 498-04**



6 mm  
**KB 498-06**



8 mm  
**KB 498-08**



10 mm  
**KB 498-10**



12 mm  
**KB 498-12**

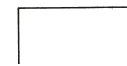

15 mm  
**KB 498-15**

1/2



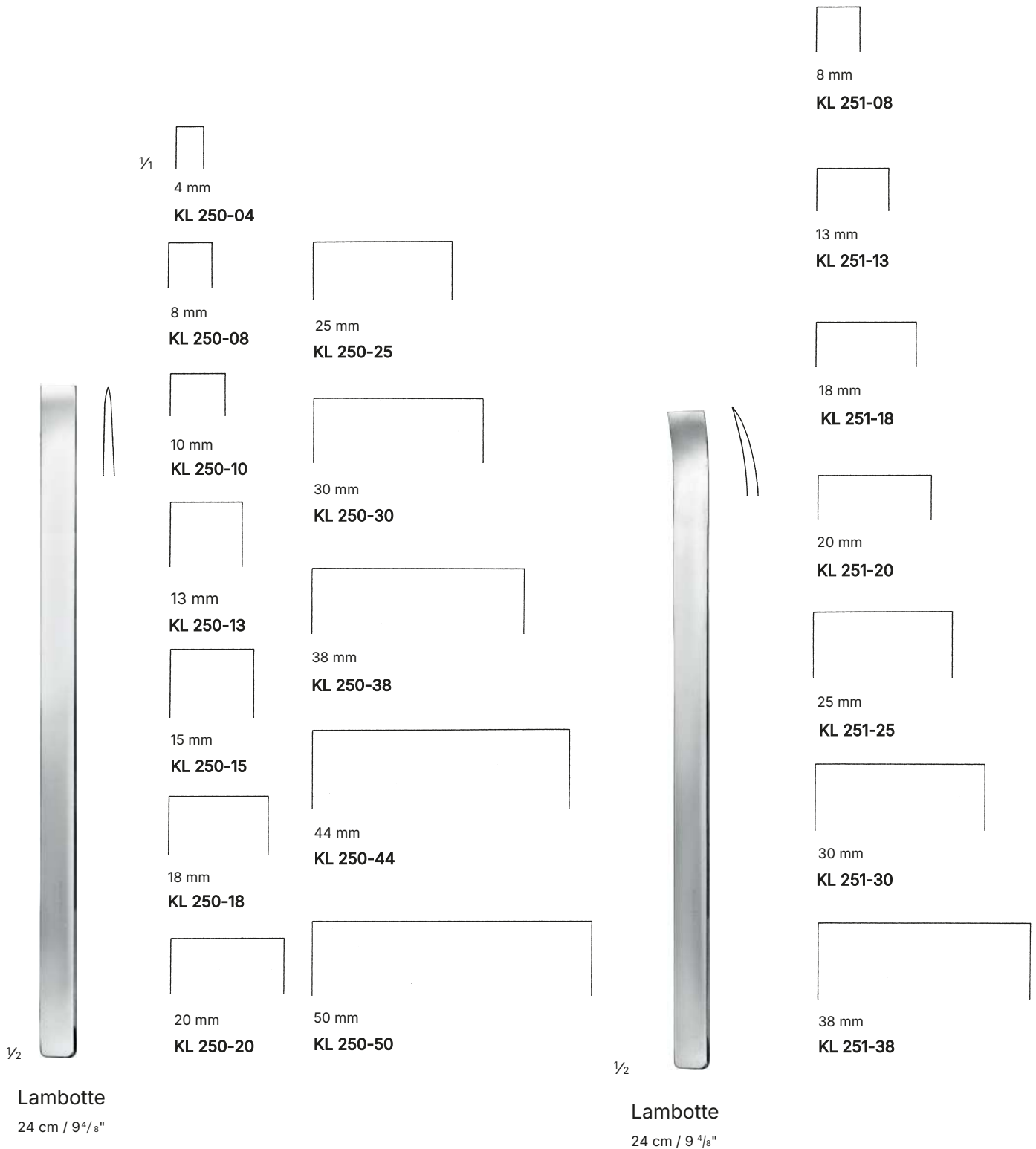

**Lambotte-Mini**  
12,5 cm / 4 7/8"

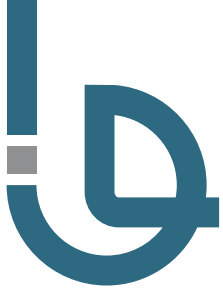



$\frac{1}{4}$    
 $\varnothing$  3 mm  
OG 354-01

  
 $\varnothing$  5 mm  
OG 354-02

  
 $\varnothing$  8 mm  
OG 354-03



$\frac{1}{2}$

Caspar  
20 cm / 8"

$\frac{1}{4}$    
 $\varnothing$  12 mm  
OG 355-01

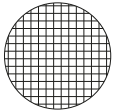
  
 $\varnothing$  14 mm  
OG 355-02

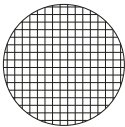
  
 $\varnothing$  16 mm  
OG 355-03



$\frac{1}{2}$

Caspar  
20 cm / 8"

Ø 30 mm



1/2

**Cottle**  
**KB 902-18**  
19 cm / 7 4/8"  
plane / convex

Ø 34 mm



1/2

**KL 602-24**  
24,5 cm / 9 5/8"

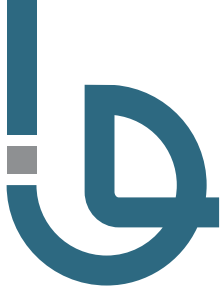

1/1 

3,0 mm  
Fig.0000  
**OG 254-01**



3,7 mm  
Fig.000  
**OG 254-02**

1/1 

2,8 mm  
Fig.0000  
**OG 259-01**



4,5 mm  
Fig.00  
**OG 254-03**



5,2 mm  
Fig.0  
**OG 254-04**



3,6 mm  
Fig.000  
**OG 259-02**



6,8 mm  
Fig.1  
**OG 254-05**



8,5 mm  
Fig.2  
**OG 255-01**



4,4 mm  
Fig.00  
**OG 259-03**

oval spoon

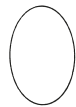

10,0 mm  
Fig.3  
**OG 255-02**

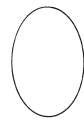

11,5 mm  
Fig.4  
**OG 255-03**

oval spoon

1/1 

2,0 mm  
Fig.1  
**OG 257-02**

oval spoon



5,2 mm  
Fig.0  
**OG 259-04**



2,4 mm  
Fig.2  
**OG 257-03**



2,6 mm  
Fig.3  
**OG 257-04**

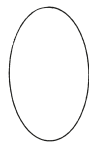

13,0 mm  
Fig.5  
**OG 255-04**



14,5 mm  
Fig.6  
**OG 255-05**



2,8 mm  
Fig.4  
**OG 257-05**

1/2



**Volkmann**

17 cm / 6 5/8"

1/2



**Lempert**

21,5 cm / 8 4/8"

1/2



**Daubenspeck**

20 cm / 7 7/8"



4,8 mm  
**OG 260-01**



4,8 mm  
**OG 261-01**

oval spoon



1/2

25 cm / 9 7/8"



4,8 mm  
**OG 262-01**

round spoon



Ø 6,5 mm

6,0 mm



1/4

oval spoon

1/2

**OG 706-21**

21 cm / 8 2/8"

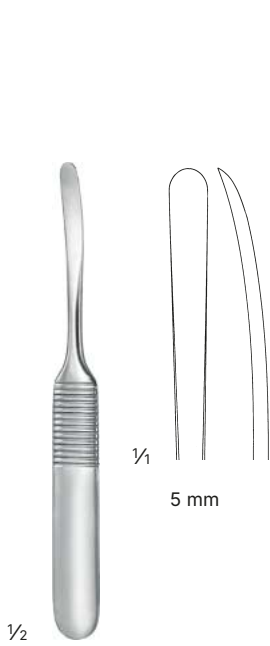
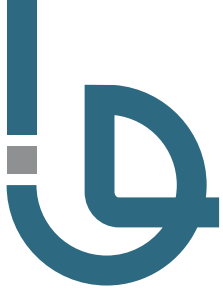

**Williger**  
**OG 277-01**  
13 cm / 5 1/8"

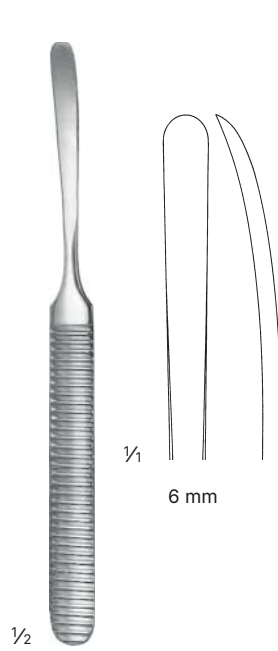

**Williger**  
**OG 277-02**  
16 cm / 6 4/8"

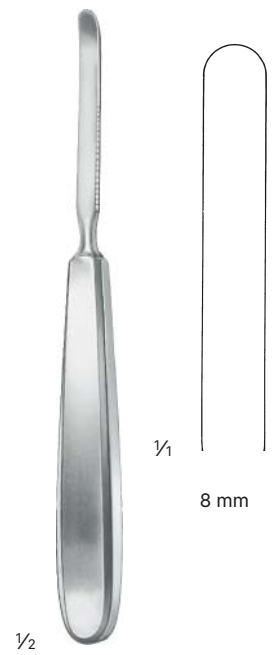

**OG 288-02**  
16,5 cm / 6 4/8"

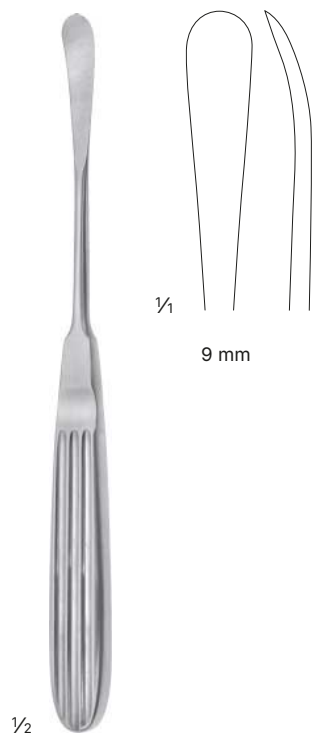

**Cottle**  
**KB 463-20**  
19,5 cm / 7 5/8"

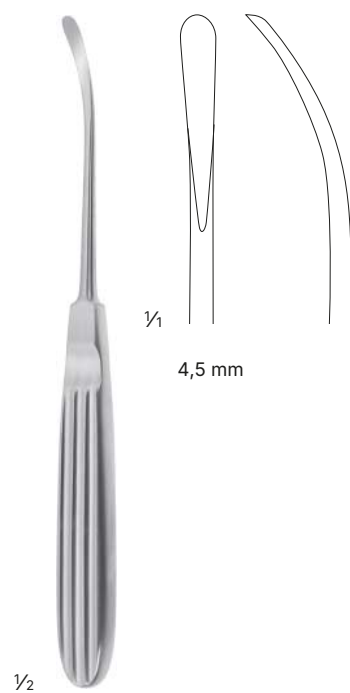

**Landolt**  
**OG 279-17**  
17,5 cm / 6 7/8"



1/1

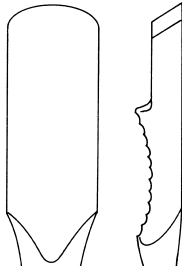

12,5 mm  
OG 280-14

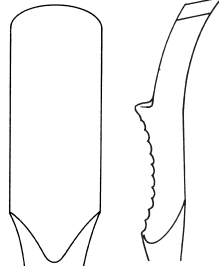

12,5 mm  
OG 281-14



1/1

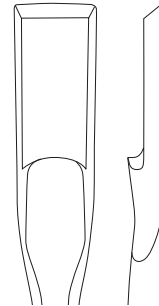

11 mm  
OG 282-16

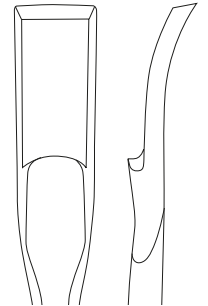

11 mm  
OG 283-16

1/2

**Farabeuf**  
15 cm / 5 7/8"

1/2

**Farabeuf-Collin**  
16 cm / 6 2/8"



1/1

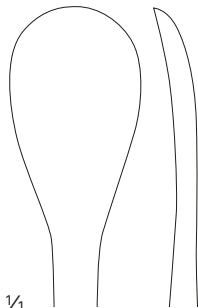

18 mm

1/2

**Sedillot**  
OG 284-18  
18,5 cm / 7 2/8"



1/1

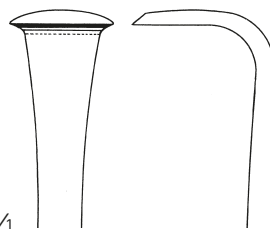

14 mm

1/2

**Langenbeck**  
OG 286-18  
19 cm / 7 4/8"



1/1

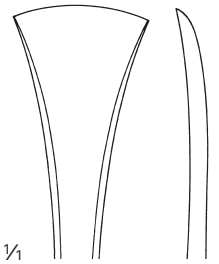

18 mm

1/2

**Langenbeck**  
OG 286-19  
19 cm / 7 4/8"



1/4

5 mm

**OG 276-05**



10 mm

**OG 276-10**

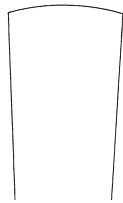

15 mm

**OG 276-15**

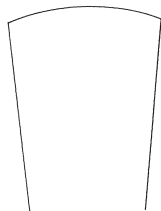

20 mm

**OG 276-20**

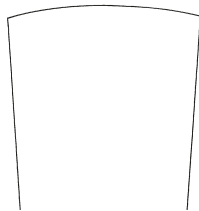

25 mm

**OG 276-25**



1/2

**Lambotte**  
21,5 cm / 8 4/5"



1/2

**Cobb**  
28 cm / 11"



10 mm

**OG 291-10**



13 mm

**OG 291-13**

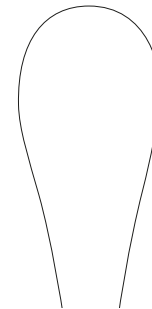

19 mm

**OG 291-19**



**OG 350-01**  
19 cm / 7 4/8"

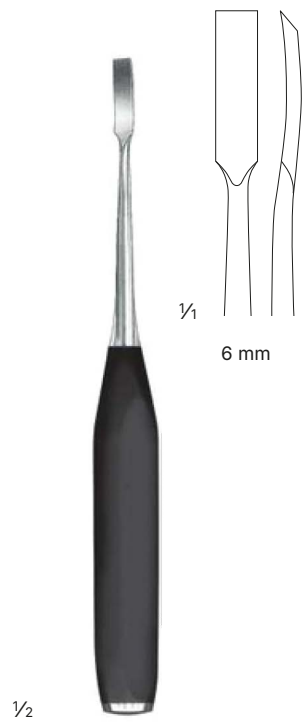

**OG 350-02**  
18 cm / 7 1/8"



**OG 350-03**  
18 cm / 7 1/8"

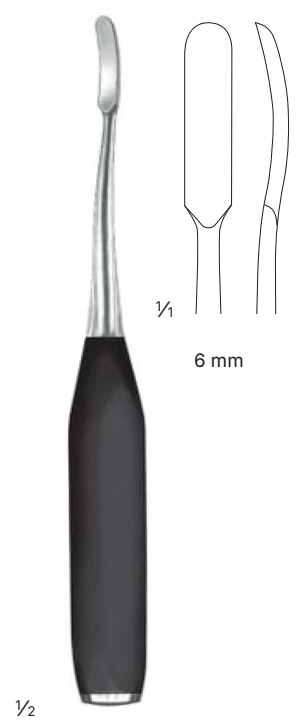

**OG 350-04**  
18 cm / 7 1/8"



**OG 351-01**  
20 cm / 7 7/8"



**OG 351-02**  
20 cm / 7 7/8"

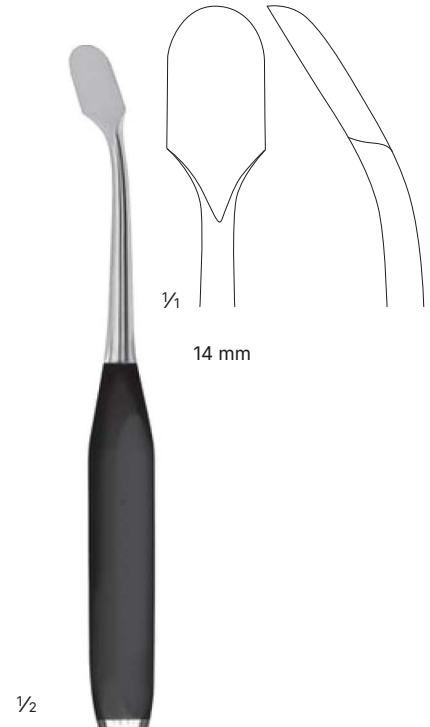

**OG 351-03**  
20 cm / 7 7/8"

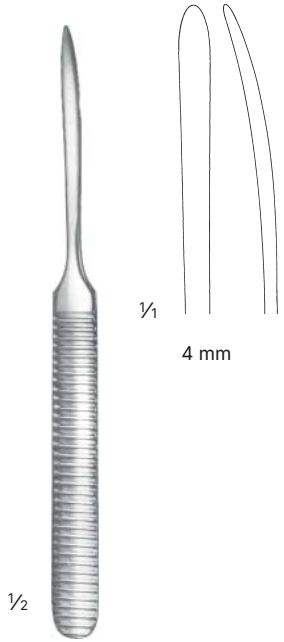

**Williger**  
**OG 220-01**  
16 cm / 6 2/8"

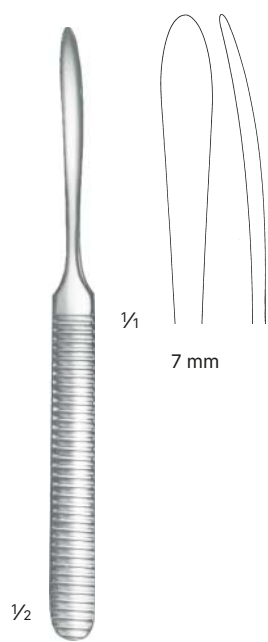

**Williger**  
**OG 220-02**  
17 cm / 6 6/8"

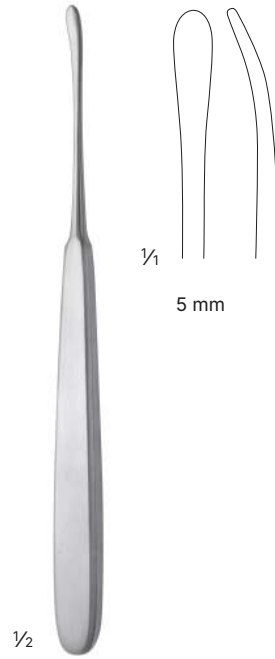

**Sebileau**  
**OG 220-17**  
17 cm / 6 6/8"

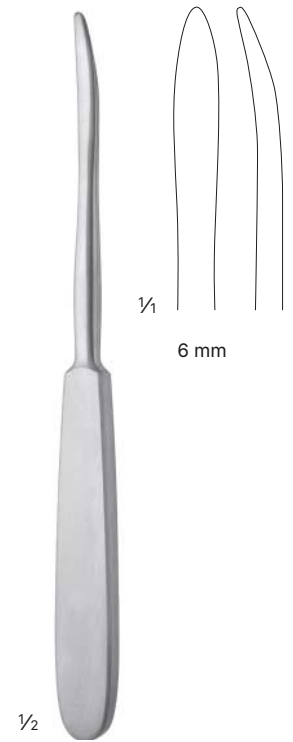

**Quervain**  
**OG 221-19**  
19,5 cm / 7 5/8"



**Langenbeck**

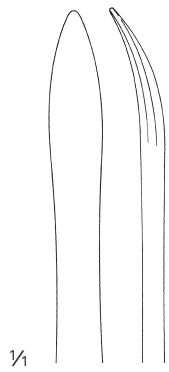

8 mm  
**OG 222-01**  
19,5 cm / 7 5/8"



10 mm  
**OG 222-02**  
19,5 cm / 7 5/8"

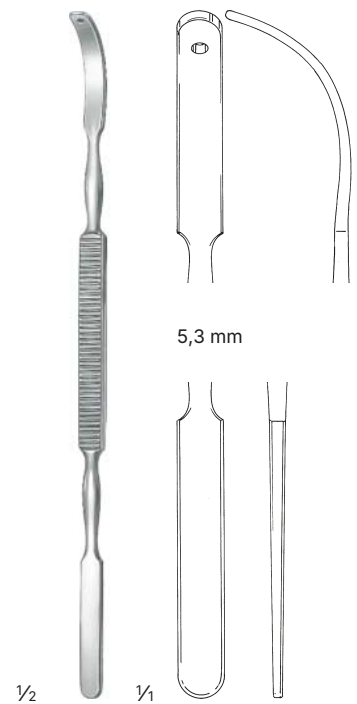

**McDonald**  
**KB 357-19**  
18,5 cm / 7 2/8"

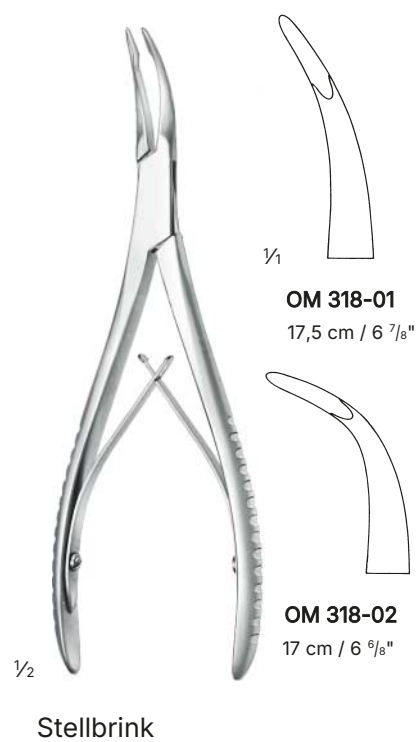
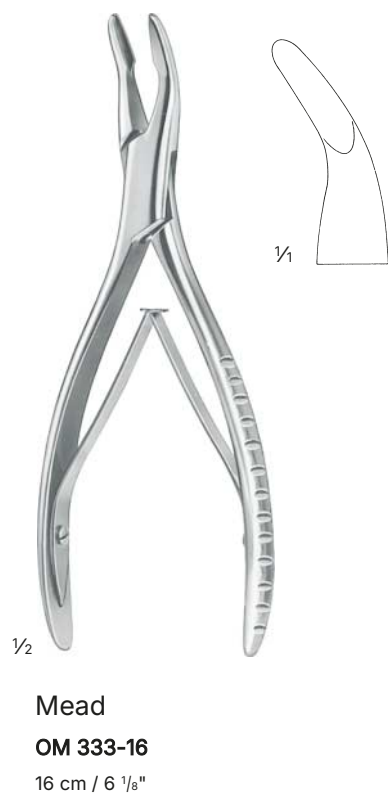
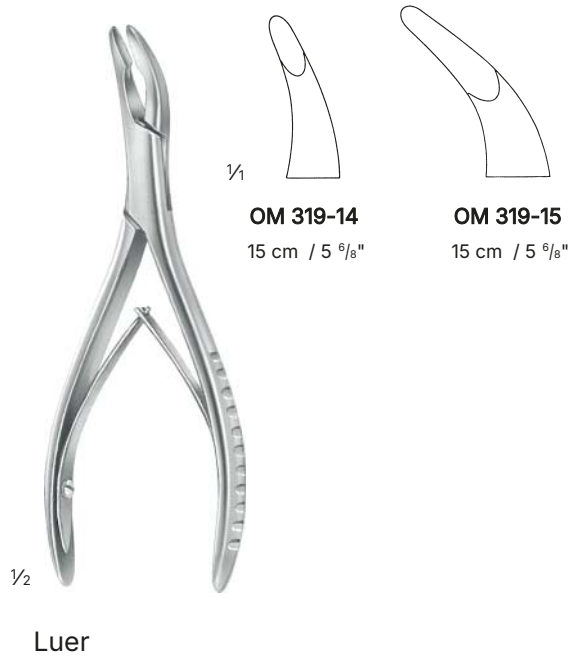



1/2

**Luer**

17cm / 6 3/4"

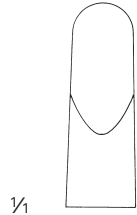

1/1

**OM 340-01**



**OM 340-02**



1/2

**Hartmann**

**OM 322-18**

18 cm / 7 1/8"

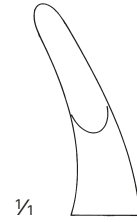

1/1



1/2

**Jansen**

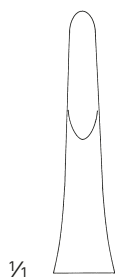

1/1

**OM 321-01**

18 cm / 7 1/8"



**OM 321-02**

18 cm / 7 1/8"

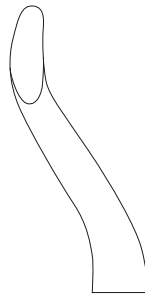

**OM 329-19**

19 cm / 7 5/8"



1/2

**Lempert**

18,5 cm / 7 3/8"



1/1

**OM 330-20**



**OM 331-21**



**Boehler**  
15 cm / 5 7/8"



**Beyer**  
**OM 335-18**  
18 cm / 7 1/8"



**Zaufal-Jansen**  
**OM 336-18**  
18 cm / 7 1/8"



**Mayfield**  
**OM 340-17**  
17 cm / 6 5/8"



1/2

Ruskin  
OM 337-19  
18 cm / 7 1/8"



1/2

Marquard  
OM 340-20  
20 cm / 7 7/8"



1/2

Ruskin  
OM 338-24  
23 cm / 9 1/8"

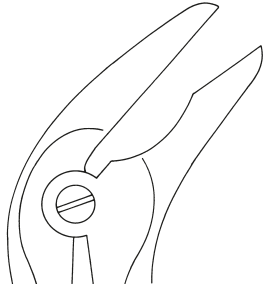

1/2

**Frykholm**  
**OM 352-24**  
24 cm / 9 1/8"



1/2

**Leksell-Stille**  
**OM 354-24**  
24 cm / 9 1/8"

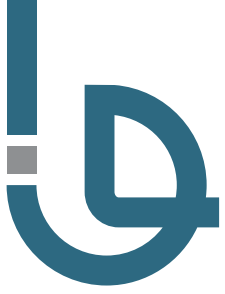

Echlin  
23 cm / 9 "

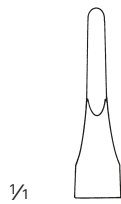

OM 350-23



OM 351-23



OM 351-25



Stille  
OM 353-23  
23,5 cm / 9 2/8"

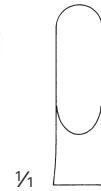

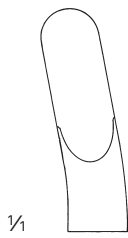

1/4

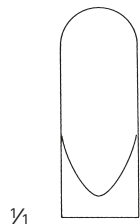

1/4

**OM 357-22**

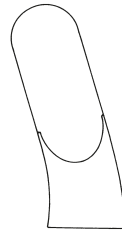

**OM 358-22**

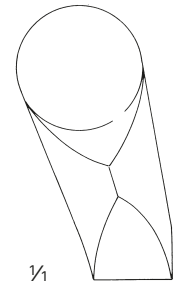

1/4



1/2

**Stille-Ruskin**

**OM 355-24**

24 cm / 9 5/8"



1/2

**Stille-Luer**

22,5 cm / 8 7/8"



1/2

**Semb**

**OM 358-27**

23,5 cm / 9 2/8"



1/2

Liston

1/4



**OM 360-14**  
14 cm / 5 4/8"



**OM 360-17**  
17 cm / 6 6/8"



**OM 360-20**  
20 cm / 7 7/8"



**OM 360-22**  
22 cm / 8 5/8"



1/2

Liston

1/4

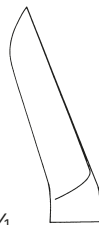

**OM 361-14**  
14 cm / 5 4/8"

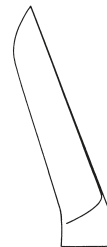

**OM 361-17**  
17 cm / 6 6/8"

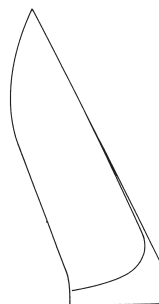

**OM 361-20**  
20 cm / 7 7/8"

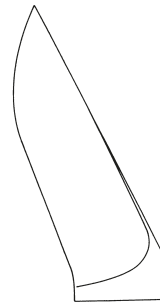

**OM 361-22**  
22 cm / 8 5/8"



1/2

Ruskin-Liston

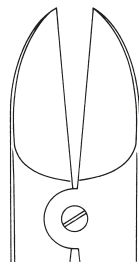

1/1

**OM 362-19**  
19 cm / 7 4/8"



**OM 363-19**  
18,5 cm / 7 2/8"



1/2

Stille-Liston

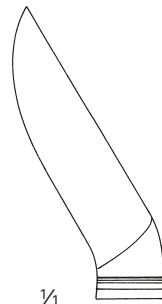

1/1

**OM 365-24**  
24 cm / 9 3/8"



**OM 367-28**  
28 cm / 11"



1/2

Gigli  
OF 665-00  
Handle



1/2

Gigli

OF 940-30  
30 cm / 11 5/8"

OF 940-40  
40 cm / 15 5/8"

OF 940-50  
50 cm / 19 5/8"



1/2

De Martel  
OF 945-33  
33 cm / 13 "  
Guide



1/2

De Vilbiss  
OM 150-21  
21 cm / 8 2/8"



1/2

Dahlgren  
OM 151-21  
21 cm / 8 2/8"



1/3

Fig. 1

**RG 610-09**

Conical burr



Fig. 2

**RG 610-14**

Conical burr



Fig. 3

**RG 610-16**

Spherical burr



Fig. 4

**RG 610-22**

Spherical burr



1/3

Hudson  
**RG 605-01**  
28 cm / 11 "



1/3

Fig. 5

**RG 611-14**

Flat burr



Fig. 6

**RG 612-02**

Twist drill



Fig. 7

**RG 610-13**

Burr

**RG 605-00**

complete, with burrs no. 1 - 4 and extension piece



Fig. 8

**RG 605-02**

Extension piece

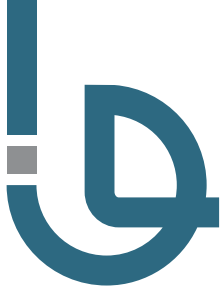

Caspar

<b>EK 676-01</b>	40x23 mm
<b>EK 676-02</b>	45x23 mm
<b>EK 676-03</b>	50x23 mm
<b>EK 676-04</b>	55x23 mm
<b>EK 676-05</b>	60x23 mm



Caspar

<b>EK 677-01</b>	40x23 mm
<b>EK 677-02</b>	45x23 mm
<b>EK 677-03</b>	50x23 mm
<b>EK 677-04</b>	55x23 mm
<b>EK 677-05</b>	60x23 mm



Caspar

<b>EK 678-01</b>	45x23 mm
<b>EK 678-02</b>	50x23 mm
<b>EK 678-03</b>	55x23 mm
<b>EK 678-04</b>	60x23 mm
<b>EK 678-05</b>	65x23 mm



Caspar

**EK 679-00**

125 mm

Frame only



Caspar

<b>EK 679-01</b>	50x25 mm
<b>EK 679-02</b>	60x25 mm



Caspar  
**EK 680-00**  
 125 mm  
 Frame only



Caspar  
**EK 681-01**  
 38 mm



Caspar  
**EK 681-02**  
 58 mm



Caspar

- EK 682-01**      30x22 mm
- EK 682-02**      35x22 mm
- EK 682-03**      40x22 mm
- EK 682-04**      45x22 mm
- EK 682-05**      50x22 mm
- EK 682-06**      55x22 mm
- EK 682-07**      60x22 mm
- EK 682-08**      65x22 mm



Caspar

- EK 683-01**      30x37 mm
- EK 683-02**      35x37 mm
- EK 683-03**      40x37 mm
- EK 683-04**      45x37 mm
- EK 683-05**      50x37 mm
- EK 683-06**      55x37 mm
- EK 683-07**      60x37 mm
- EK 683-08**      65x37 mm



Caspar

- EK 684-01**      30x52 mm
- EK 684-02**      35x52 mm
- EK 684-03**      40x52 mm
- EK 684-04**      45x52 mm
- EK 684-05**      50x52 mm
- EK 684-06**      55x52 mm
- EK 684-07**      60x52 mm
- EK 684-08**      65x52 mm

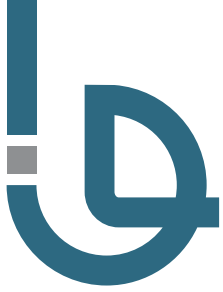

**Cloward**  
**EK 700-00**  
Complete with 5 pair blades



**Cloward**  
toothed, pair

- |                  |       |
|------------------|-------|
| <b>EK 701-01</b> | 40 mm |
| <b>EK 701-02</b> | 45 mm |
| <b>EK 701-03</b> | 50 mm |
| <b>EK 701-04</b> | 55 mm |
| <b>EK 701-05</b> | 60 mm |



**Cloward**  
pair

- |                  |       |
|------------------|-------|
| <b>EK 702-01</b> | 40 mm |
| <b>EK 702-02</b> | 45 mm |
| <b>EK 702-03</b> | 50 mm |
| <b>EK 702-04</b> | 55 mm |
| <b>EK 702-05</b> | 60 mm |

**EK 700-01**  
Retractor Only  
25 cm / 9 7/8"



**Caspar**  
**EK 710-00**

105 mm  
Frame only



**Caspar**

lateral

<b>EK 710-01</b>	35 mm
<b>EK 710-02</b>	40 mm
<b>EK 710-03</b>	45 mm
<b>EK 710-04</b>	50 mm
<b>EK 710-05</b>	55 mm
<b>EK 710-06</b>	60 mm
<b>EK 710-07</b>	65 mm
<b>EK 710-08</b>	75 mm
<b>EK 710-09</b>	80 mm
<b>EK 710-10</b>	85 mm



**Caspar**

medial

<b>EK 710-11</b>	40 mm
<b>EK 710-12</b>	45 mm
<b>EK 710-13</b>	50 mm
<b>EK 710-14</b>	55 mm
<b>EK 710-15</b>	60 mm
<b>EK 710-16</b>	65 mm
<b>EK 710-17</b>	70 mm



**Caspar**

<b>EK 711-01</b>	40 mm
<b>EK 711-02</b>	45 mm
<b>EK 711-03</b>	50 mm
<b>EK 711-04</b>	55 mm
<b>EK 711-05</b>	60 mm
<b>EK 711-06</b>	65 mm
<b>EK 711-07</b>	75 mm
<b>EK 711-08</b>	80 mm



Caspar  
**EK 672-01**  
120 mm  
Frame only  
double hinged



Caspar  
**EK 673-01**  
120mm  
Frame only  
hinged



1/2  
**EK 675-00**  
12 cm / 4 7/8"  
Blade Changing Forceps



1/2  
**Caspar**  
**EK 674-01**  
16,5 cm / 6 4/8"  
double hinged



Scoville  
**EK 669-00**  
220 mm  
Frame only



Scoville-Haverfield  
**EK 670-00**  
220 mm  
Frame only  
hinged

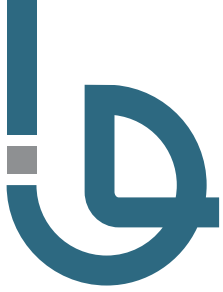

Scoville  
blunt  
**EK 670-01**  
50 mm



Scoville  
blunt  
**EK 670-02**  
70 mm



Scoville  
sharp  
**EK 670-03**  
50 mm



Scoville  
sharp  
**EK 670-04**  
70 mm



Scoville  
toothed  
**EK 671-01** 60x25 mm  
**EK 671-02** 61x50 mm  
**EK 671-03** 86x25 mm



Scoville  
sharp  
**EK 671-04** 48x50 mm  
**EK 671-05** 64x50 mm  
**EK 671-06** 64x64 mm  
**EK 671-07** 80x57 mm



Scoville  
toothed  
**EK 671-08** 44x38 mm  
**EK 671-09** 67x44 mm



Caspar  
EK 720-01  
130 mm  
right

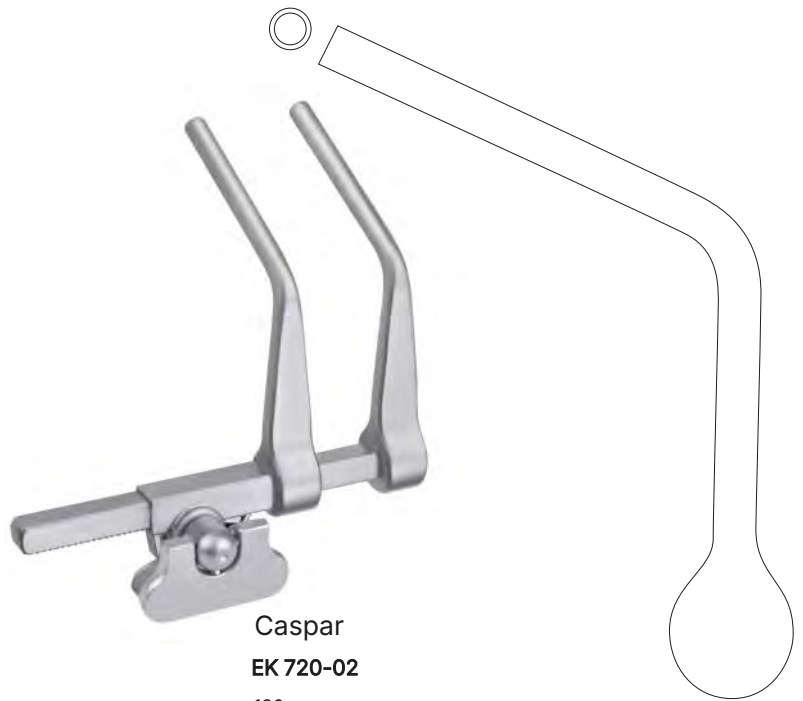

Caspar  
EK 720-02  
130 mm  
left



1/2  
Caspar  
EK 720-03  
200 mm  
right

EK 720-04  
200 mm  
left



1/2  
Caspar  
EK 720-05  
230 mm

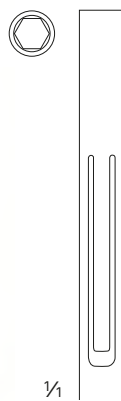

Ø8 mm



Caspar  
EK 720-06  
14 mm

Ø8 mm



Caspar  
EK 720-07 12 mm  
EK 720-08 14 mm  
EK 720-09 16 mm  
EK 720-10 18 mm

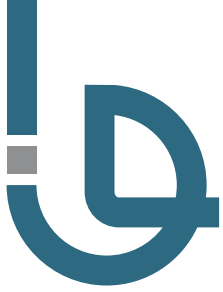

$\frac{1}{2}$   
**Raney**  
**OF 190-16**  
16 cm / 6  $\frac{2}{8}$ "

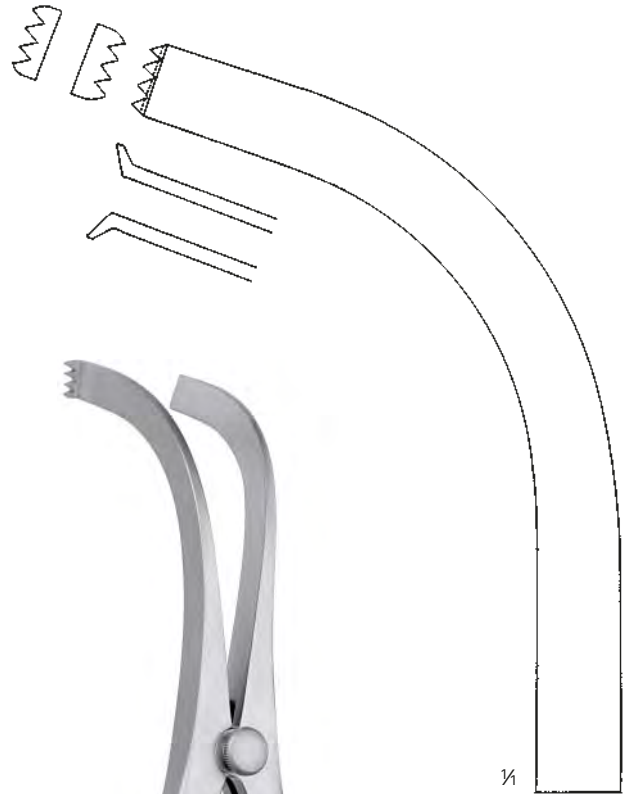

$\frac{1}{4}$

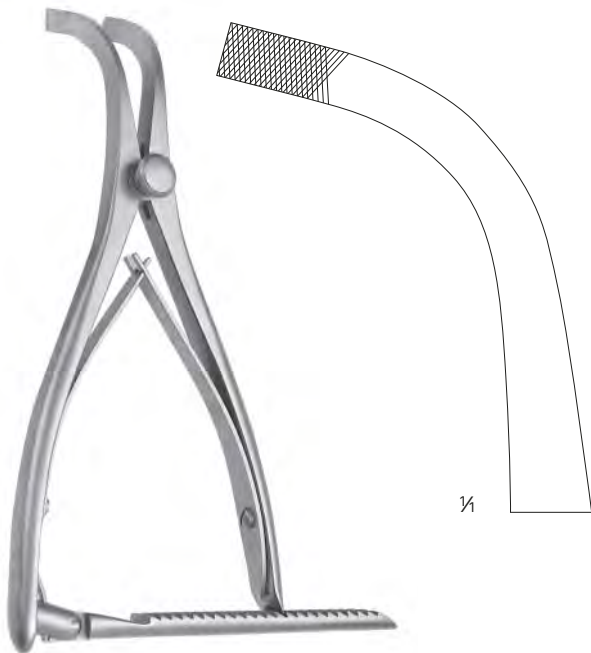

$\frac{1}{4}$

$\frac{1}{2}$   
**Inge**  
**OF 190-17**  
17 cm / 6  $\frac{5}{8}$ "



$\frac{1}{2}$   
**Inge**  
**OF 190-27**  
27,5 cm / 10  $\frac{6}{8}$ "

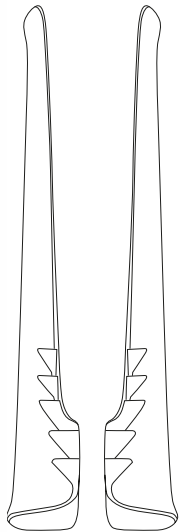

Cushing-Landolt  
**EK 712-01**  
 70x16 mm

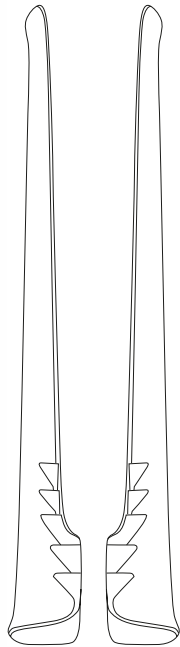

Cushing-Landolt  
**EK 712-02**  
 90x16 mm

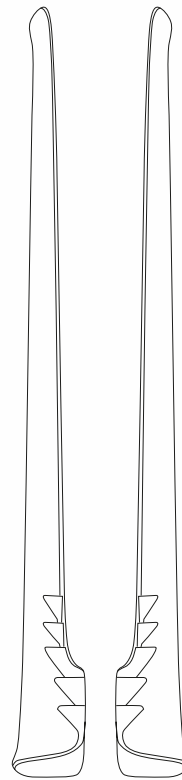

Cushing-Landolt  
**EK 712-03**  
 110x16 mm



1/3

**Taylor**  
 16 cm / 6 2/8"

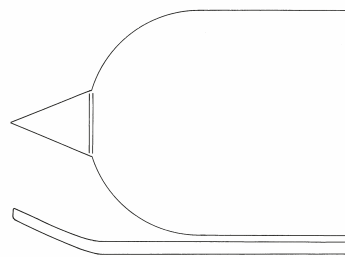

1/1

95 x 30 mm  
**EK 228-07**  
 16 cm / 6 2/8"

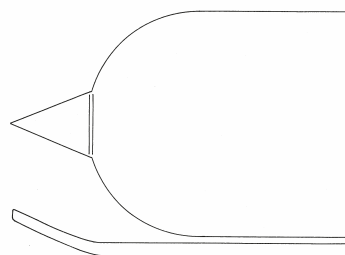

115 x 30 mm  
**EK 228-10**  
 16 cm / 6 2/8"

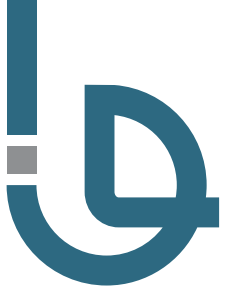

1/2



Crutchfield  
OF 300-05

175 mm  
large

OF 300-06

Spare Pin



**Cloward  
OF 191-13**  
13,5 cm / 5 1/8"



**Cloward  
OF 191-15**  
15,5 cm / 6 1/8"



**Crutchfield  
OF 300-01**  
105 mm  
small



**Crutchfield  
OF 300-02**  
155 mm  
medium



**OF 300-03**  
70 mm



**OF 300-04**  
70 mm

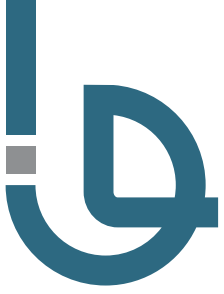

1/2

Yasargil

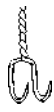

310 mm

**RG 600-01**

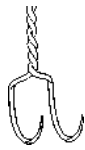

410 mm

**RG 600-02**



1/2  
22 cm / 8 5/8"



Fig.1  
**OG 268-01**  
upward

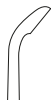

**OG 269-01**  
upward angled



**OG 270-01**  
downward



**OG 275-01**  
downward angled

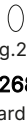

Fig.2  
**OG 268-02**  
upward

**OG 269-02**  
upward angled

**OG 270-02**  
downward

**OG 275-02**  
downward angled

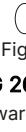
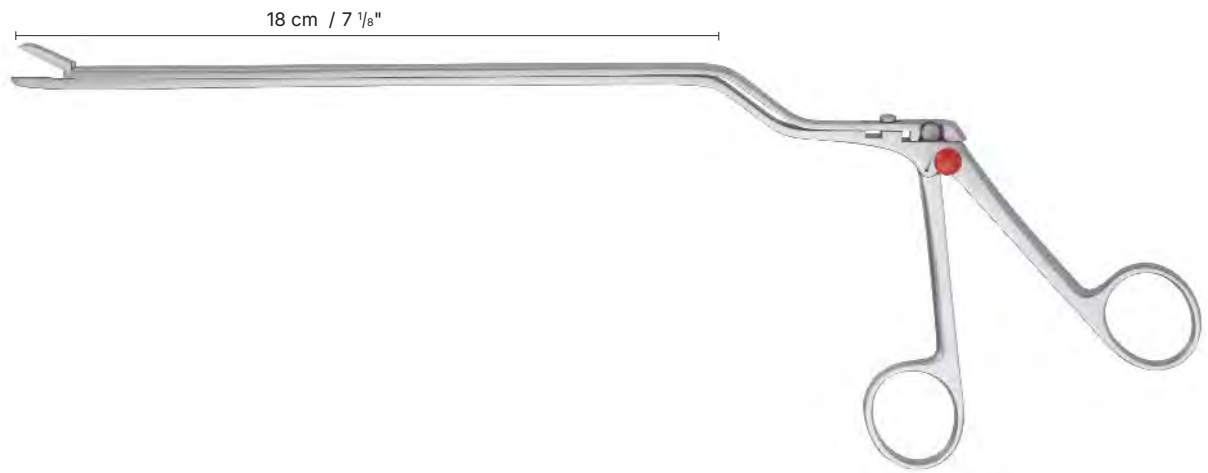

Fig.3  
**OG 268-03**  
upward





**OG 269-03**  
upward angled

**OG 270-03**  
downward

**OG 275-03**  
downward angled



Caspar

- |      |   |                  |
|------|---|------------------|
| 2 mm |  | <b>RG 370-07</b> |
| 3 mm |  | <b>RG 371-02</b> |
| 4 mm |  | <b>RG 371-03</b> |
| 5 mm |  | <b>RG 372-09</b> |

# Suction Tubes



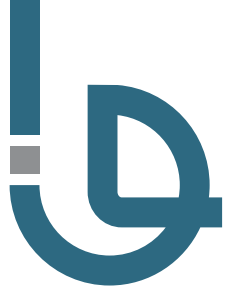

	working length	tube diameter
<b>AS 100-04</b>	110 mm	Ø1,5 mm
<b>AS 100-06</b>	110 mm	Ø2,0 mm
<b>AS 100-08</b>	110 mm	Ø2,5 mm
<b>AS 100-10</b>	110 mm	Ø3,0 mm
<b>AS 100-12</b>	110 mm	Ø4,0 mm
<b>AS 100-15</b>	110 mm	Ø5,0 mm
<b>AS 101-04</b>	130 mm	Ø1,5 mm
<b>AS 101-06</b>	130 mm	Ø2,0 mm
<b>AS 101-08</b>	130 mm	Ø2,5 mm
<b>AS 101-10</b>	130 mm	Ø3,0 mm
<b>AS 101-12</b>	130 mm	Ø4,0 mm
<b>AS 101-15</b>	130 mm	Ø5,0 mm
<b>AS 102-04</b>	160 mm	Ø1,5 mm
<b>AS 102-06</b>	160 mm	Ø2,0 mm
<b>AS 102-08</b>	160 mm	Ø2,5 mm
<b>AS 102-10</b>	160 mm	Ø3,0 mm
<b>AS 102-12</b>	160 mm	Ø4,0 mm
<b>AS 102-15</b>	160 mm	Ø5,0 mm
<b>AS 103-04</b>	200 mm	Ø1,5 mm
<b>AS 103-06</b>	200 mm	Ø2,0 mm
<b>AS 103-08</b>	200 mm	Ø2,5 mm
<b>AS 103-10</b>	200 mm	Ø3,0 mm
<b>AS 103-12</b>	200 mm	Ø4,0 mm
<b>AS 103-15</b>	200 mm	Ø5,0 mm



1/2

Fergusson



Frazier

19,5 cm / 7 5/8"

working length tube diameter

<b>AS 120-15</b>	130 mm	Ø1,5 mm
<b>AS 120-20</b>	130 mm	Ø2 mm
<b>AS 120-25</b>	130 mm	Ø2,5 mm
<b>AS 120-30</b>	130 mm	Ø3,0 mm
<b>AS 120-35</b>	130 mm	Ø3,5 mm
<b>AS 120-40</b>	130 mm	Ø4,0 mm
<b>AS 120-50</b>	130 mm	Ø5,0 mm



1/2

Plester

19,5 cm / 7 5/8"

<b>AS 200-15</b>	Ø1,5 mm
<b>AS 200-20</b>	Ø2,0 mm
<b>AS 200-25</b>	Ø2,5 mm
<b>AS 200-30</b>	Ø3,0 mm

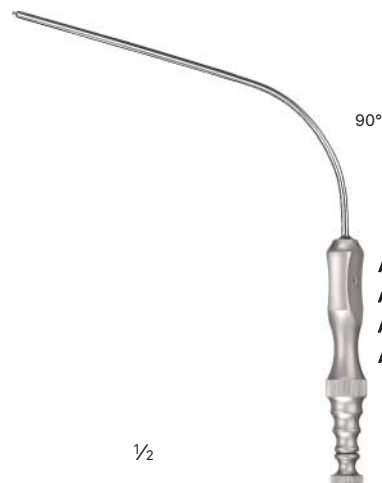

Frazier

13 cm / 5 1/8"

working length tube diameter

<b>AS 201-02</b>	90 mm	Ø2,0 mm
<b>AS 201-03</b>	90 mm	Ø3,0 mm
<b>AS 201-04</b>	90 mm	Ø4,0 mm
<b>AS 201-05</b>	90 mm	Ø5,0 mm

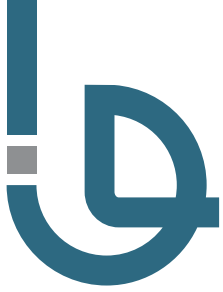

1/2

Baron

**AS 270-01**  
**AS 270-02**  
**AS 270-03**

working length	tube diameter
75 mm	Ø1,0 mm
75 mm	Ø1,5 mm
75 mm	Ø2,0 mm

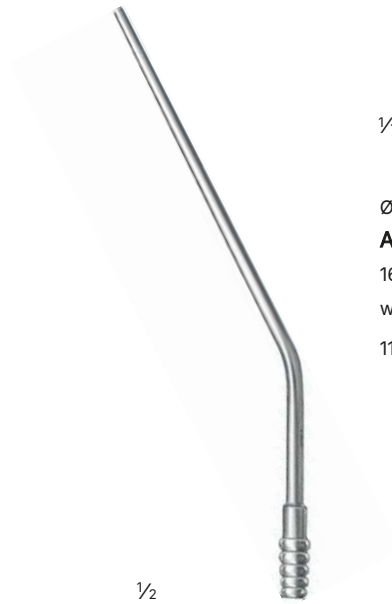

1/2

Luer

working length	tube diameter
110 mm	Ø3,0 mm
110 mm	Ø3,5 mm

**AS 111-30**  
 16,5 cm / 6<sup>4</sup>/<sub>8</sub>"  
 working length

**AS 111-35**  
 16,5 cm / 6<sup>4</sup>/<sub>8</sub>"  
 working length



1/2

AS 310-01

**AS 310-00**  
 complete, 1 handle 4 tips

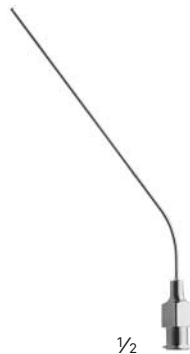

1/2

<b>AS 310-02</b>	Ø0,5 mm
<b>AS 310-03</b>	Ø0,7 mm
<b>AS 310-04</b>	Ø1,0 mm
<b>AS 310-05</b>	Ø1,3 mm



1/2

**House**  
**AS 311-05**  
 4,5 cm / 1<sup>5</sup>/<sub>8</sub>"  
 Suction adapter

☞ **AS 310-03**  
**AS 310-04**  
**AS 310-05**



1/2

Ø2,3 mm

**Wullstein**

**AS 300-00**

14 cm / 5 1/8"

Complete, with handle and 3 tips



1/4

4,5 cm / 1 3/8"

Micro suction cannula



**AS 300-00**

**AS 300-01**

**AS 300-02**

**AS 300-03**

**AS 300-04**

tube diameter

Ø0,4 mm

Ø0,6 mm

Ø0,8 mm



1/2

Ø2,5 mm

**Wullstein**

**AS 300-01**

14 cm / 5 1/8"

Handle with tube, only



1/2

**Landolt**

Ø3,2 mm

**AS 500-65**

15 cm / 5 7/8"

insulated

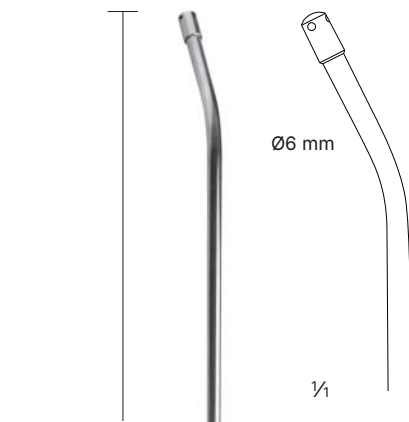
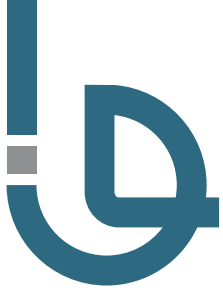

Working length  
29 cm / 11 <sup>7</sup>/<sub>8</sub>"

1/2

**AS 352-27**

Ø3,2 mm

1/2

**Landolt  
AS 315-20**

20 cm / 7 <sup>7</sup>/<sub>8</sub>"

Suction tube for pituitary



Ø10 mm  
**AS 356-28**  
28,5 cm / 11 1/8"



1/2  
**Poole**  
**AS 360-01**  
24 cm / 9 4/8"  
Ø10 mm



1/2  
**Poole**  
**AS 360-02**  
24 cm / 9 4/8"  
Ø8 mm







Ø0,6 mm



1/4

3,2 mm

**HO 254-01**

ball ended

Ø1,1 mm



4,5 mm

**HO 254-02**

ball ended

Ø0,6 mm



3,2 mm

**HO 254-03**

blunt

Ø0,8 mm

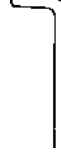

3,2 mm

**HO 254-04**

blunt

**Krayenbuehl**

19 cm / 7 4/8"



insulated

Ø1,8 mm

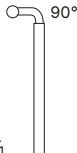

1/4

5 mm

**HO 255-01**

Ø2 mm

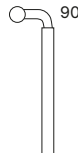

7 mm

**HO 255-02**

Ø2,5 mm

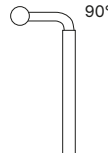

9 mm

**HO 255-03**

Ø1,8 mm

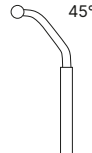

11 mm

**HO 255-04**

1/2

**Caspar**

24,5 cm / 9 5/8"

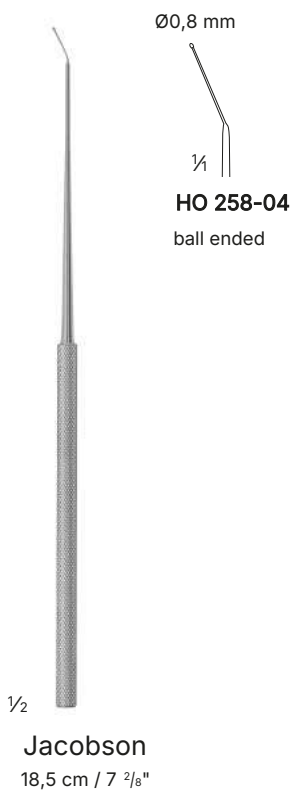
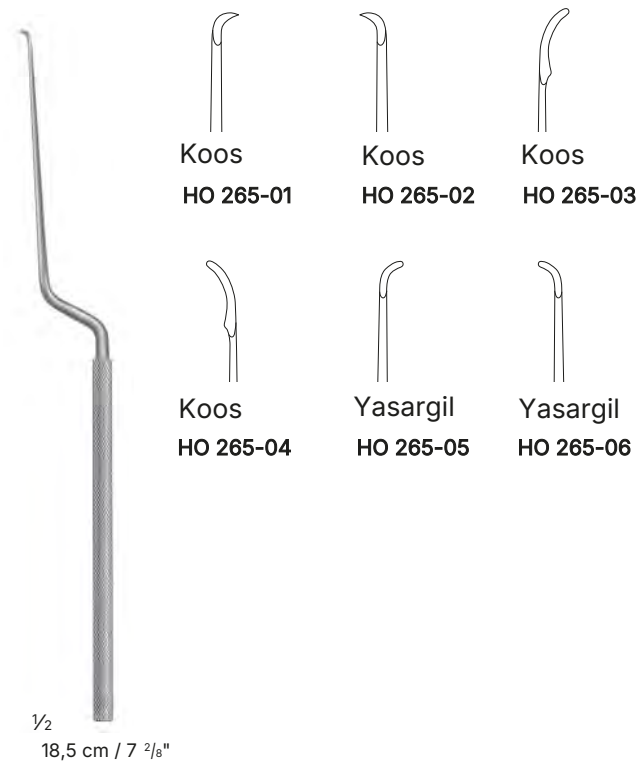

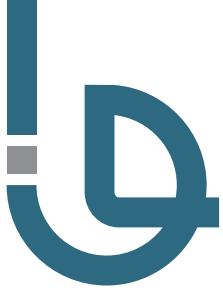

Pick

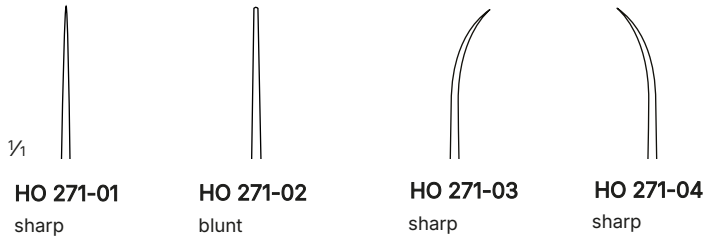

Hook

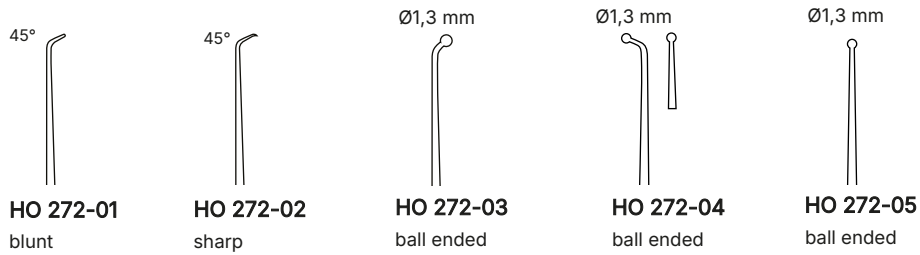

Dissector

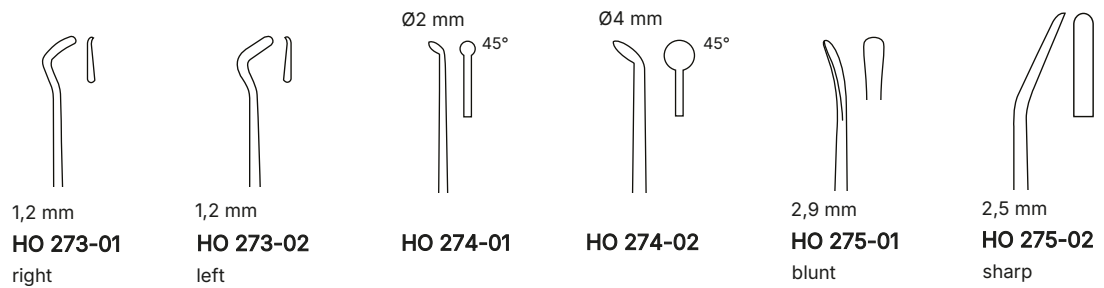

Dissector

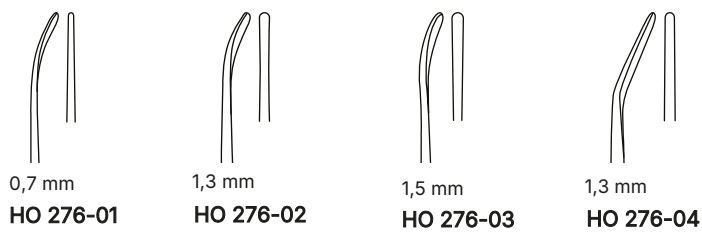

Enucleator

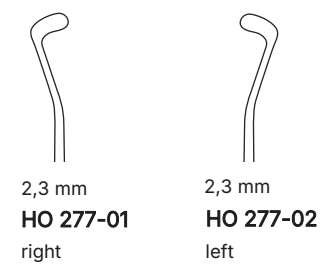

Knife



Chisel

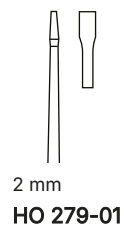

Ø1,9 mm

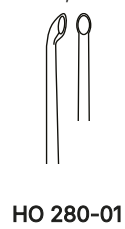

Curette

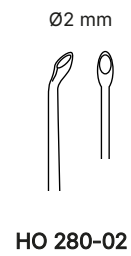

Ø2,9 mm

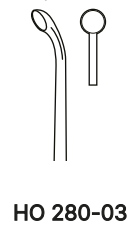

sharp

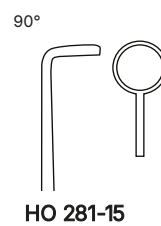
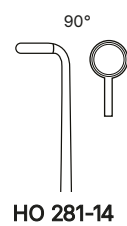
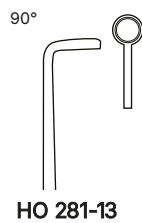
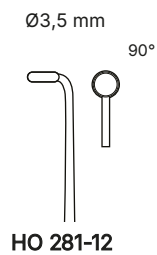
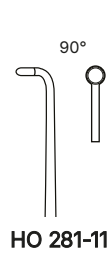
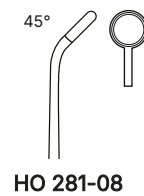
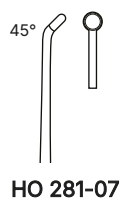
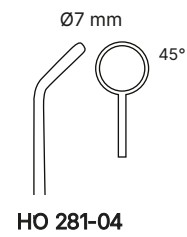
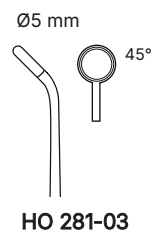
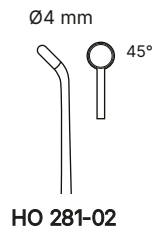
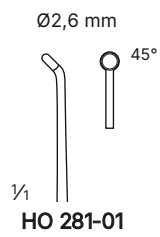

blunt

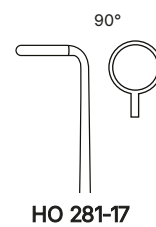
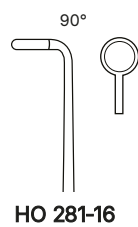
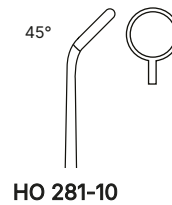
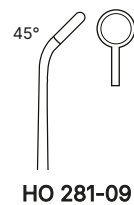
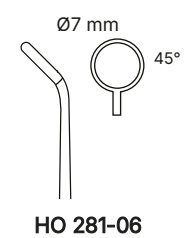
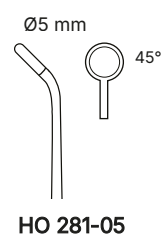
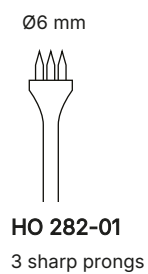

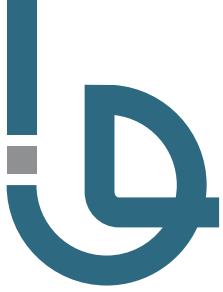

Üst  
Alt

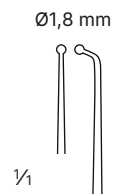

**HO 284-01**  
ball ended

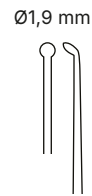

**HO 284-02**

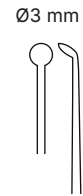

**HO 284-03**



**HO 284-04**



**HO 284-05**  
blunt



**HO 284-06**  
blunt



**HO 284-07**  
blunt



**HO 284-09**  
right

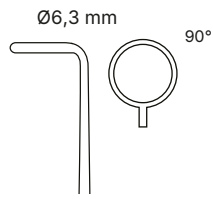

**HO 284-10**  
blunt



**HO 285-00**  
Handle for Micro Instruments



1/2

**Samii**

23 cm / 9 1/8"

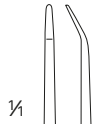

- 1 mm **HO 266-01**
- 1,5 mm **HO 266-02**
- 2 mm **HO 266-03**
- 2,5 mm **HO 266-04**
- 3 mm **HO 266-05**
- 3,5 mm **HO 266-06**
- 4 mm **HO 266-07**
- 5 mm **HO 266-08**



- Ø1,5 mm **HO 267-01**
- Ø3 mm **HO 267-02**
- Ø4,5 mm **HO 267-03**
- Ø6 mm **HO 267-04**



1/2

**Samii**

23 cm / 9 1/8"

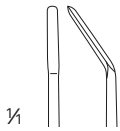

- 1,8 mm **HO 268-01**



1/2

**Yasargil**

20 cm / 7 7/8"

Ø5 mm



**HO 270-01**

Ø8 mm



**HO 270-02**

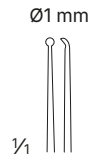
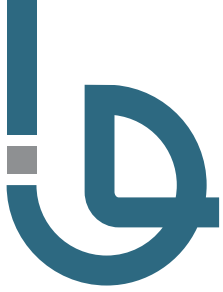

**HO 292-01**  
round

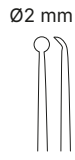

**HO 292-02**  
round

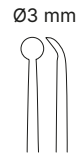

**HO 292-03**  
round



1,2 mm  
**HO 292-04**



2,8 mm  
**HO 292-05**



1 mm  
**HO 292-06**



1,5 mm  
**HO 292-07**



2 mm  
**HO 292-08**



2 mm  
**HO 292-09**  
semi-sharp



2 mm  
**HO 292-10**  
blunt



3 mm  
**HO 292-11**  
semi-sharp



**HO 292-12**



3,5 mm  
**HO 292-13**  
ball ended



**HO 292-14**  
oval

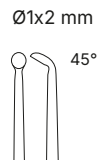

**HO 292-15**  
oval



1/2

**Yasargil**

18,5 cm / 7 2/8"



1,4 mm

**HO 296-01**

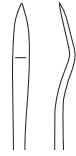

2,6 mm

**HO 296-02**



4mm

**HO 296-03**

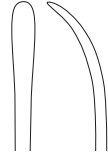

3 mm

**HO 296-04**

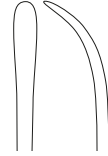

3,9 mm

**HO 296-05**



1/2

**Yasargil**

23 cm / 9 1/8"



2,2 mm

**HO 297-01**

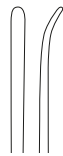

2 mm

**HO 297-02**

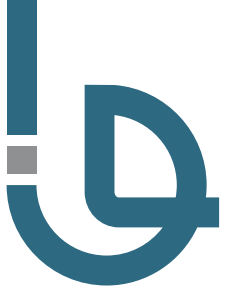

Caspar

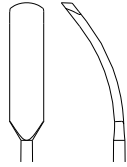

4,5 mm  
**HO 293-01**  
sharp  
23 cm / 9 1/8"



1 mm  
**HO 293-04**  
sharp  
20 cm / 7 7/8"



Caspar

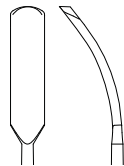

4,5 mm  
**HO 293-02**  
sharp  
23 cm / 9 1/8"

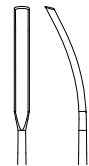

2 mm  
**HO 293-03**  
sharp  
23 cm / 9 1/8"



1 mm  
**HO 293-05**  
sharp  
20 cm / 7 7/8"



1 mm  
**HO 293-06**  
sharp  
20 cm / 7 7/8"



W/L: 7 cm / 2 3/4"

**AS 500-20** Ø2 mm

**AS 500-25** Ø2,5 mm



**Frazier**

12 cm / 4 3/4"

**AS 501-20** Ø2 mm

**AS 501-25** Ø2,5 mm

**AS 501-30** Ø3 mm



**Cushing-Cairns**

W/L: 9,5 cm / 3 3/4"

**AS 502-23** Ø2,3 mm

**AS 502-26** Ø2,6 mm



**Jefferson**

Ø1,7 mm

**AS 503-08** W/L: 8 cm / 3 1/8"

**AS 503-10** W/L: 10 cm / 3 7/8"



**Dandy**

W/L: 9,5 cm / 3 3/4"

**AS 504-20** Ø2 mm

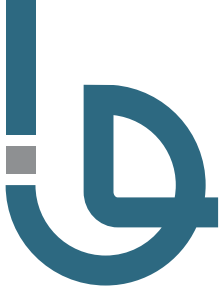

Kerrison

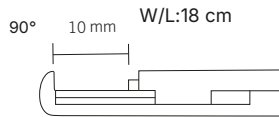

		Regular	Detachable	Black	W/L:20 cm	W/L:23 cm	W/L:23 cm
1 mm	□	<b>OF 501-01</b>	<b>OF 502-01</b>	<b>OF 501-01 B</b>	<b>OF 502-01 B</b>	<b>OF 503-01</b>	<b>OF 503-01 B</b>
2 mm	□	<b>OF 501-02</b>	<b>OF 502-02</b>	<b>OF 501-02 B</b>	<b>OF 502-02 B</b>	<b>OF 503-02</b>	<b>OF 503-02 B</b>
3 mm	□	<b>OF 501-03</b>	<b>OF 502-03</b>	<b>OF 501-03 B</b>	<b>OF 502-03 B</b>	<b>OF 503-03</b>	<b>OF 503-03 B</b>
4 mm	□	<b>OF 501-04</b>	<b>OF 502-04</b>	<b>OF 501-04 B</b>	<b>OF 502-04 B</b>	<b>OF 503-04</b>	<b>OF 503-04 B</b>
5 mm	□	<b>OF 501-05</b>	<b>OF 502-05</b>	<b>OF 501-05 B</b>	<b>OF 502-05 B</b>	<b>OF 503-05</b>	<b>OF 503-05 B</b>

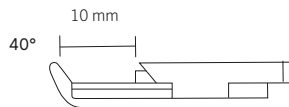

W/L:18 cm

W/L:20 cm

		Regular	Detachable	Black	Regular	Detachable	Black
1 mm	□	<b>OF 505-01</b>	<b>OF 505-01 D</b>	<b>OF 505-01 B</b>	<b>OF 506-01</b>	<b>OF 506-01 D</b>	<b>OF 506-01 B</b>
2 mm	□	<b>OF 505-02</b>	<b>OF 505-02 D</b>	<b>OF 505-02 B</b>	<b>OF 506-02</b>	<b>OF 506-02 D</b>	<b>OF 506-02 B</b>
3 mm	□	<b>OF 505-03</b>	<b>OF 505-03 D</b>	<b>OF 505-03 B</b>	<b>OF 506-03</b>	<b>OF 506-03 D</b>	<b>OF 506-03 B</b>
4 mm	□	<b>OF 505-04</b>	<b>OF 505-04 D</b>	<b>OF 505-04 B</b>	<b>OF 506-04</b>	<b>OF 506-04 D</b>	<b>OF 506-04 B</b>
5 mm	□	<b>OF 505-05</b>	<b>OF 505-05 D</b>	<b>OF 505-05 B</b>	<b>OF 506-05</b>	<b>OF 506-05 D</b>	<b>OF 506-05 B</b>

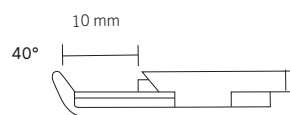

W/L:23 cm

Regular

Detachable

Black

1 mm	◦	<b>OF 507-01</b>	<b>OF 507-01 D</b>	<b>OF 507-01 B</b>
2 mm	◐	<b>OF 507-02</b>	<b>OF 507-02 D</b>	<b>OF 507-02 B</b>
3 mm	◑	<b>OF 507-03</b>	<b>OF 507-03 D</b>	<b>OF 507-03 B</b>
4 mm	◒	<b>OF 507-04</b>	<b>OF 507-04 D</b>	<b>OF 507-04 B</b>
5 mm	◓	<b>OF 507-05</b>	<b>OF 507-05 D</b>	<b>OF 507-05 B</b>



Kerrison

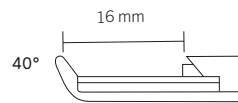

W/L:18 cm

		Detachable	Black
1 mm	○	<b>OF 512-01</b>	<b>OF 512-01 B</b>
2 mm	◐	<b>OF 512-02</b>	<b>OF 512-02 B</b>
3 mm	◑	<b>OF 512-03</b>	<b>OF 512-03 B</b>
4 mm	◒	<b>OF 512-04</b>	<b>OF 512-04 B</b>
5 mm	◓	<b>OF 512-05</b>	<b>OF 512-05 B</b>



Kerrison  
curved

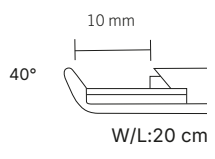

Detachable                      Black

1 mm	○	<b>OF 513-01</b>	<b>OF 513-01 B</b>
2 mm	◐	<b>OF 513-02</b>	<b>OF 513-02 B</b>
3 mm	◑	<b>OF 513-03</b>	<b>OF 513-03 B</b>
4 mm	◒	<b>OF 513-04</b>	<b>OF 513-04 B</b>
5 mm	◓	<b>OF 513-05</b>	<b>OF 513-05 B</b>



Üst  
Alt



Kerrison

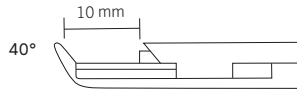

thin plate

	W/L:18 cm			W/L:20 cm			W/L:23 cm		
Regular	Detachable	Black	Regular	Detachable	Black	Regular	Detachable	Black	
OF 519-01	OF 519-01 B	OF 505-01 BD	OF 520-01	OF 520-01 B	OF 506-01 BD	OF 521-01	OF 521-01 B	OF 507-01 BD	
OF 519-02	OF 519-02 B	OF 505-02 BD	OF 520-02	OF 520-02 B	OF 506-02 BD	OF 521-02	OF 521-02 B	OF 507-02 BD	
OF 519-03	OF 519-03 B	OF 505-03 BD	OF 520-03	OF 520-03 B	OF 506-03 BD	OF 521-03	OF 521-03 B	OF 507-03 BD	
OF 519-04	OF 519-04 B	OF 505-04 BD	OF 520-04	OF 520-04 B	OF 506-04 BD	OF 521-04	OF 521-04 B	OF 507-04 BD	
OF 519-05	OF 519-05 B	OF 505-05 BD	OF 520-05	OF 520-05 B	OF 506-05 BD	OF 521-05	OF 521-05 B	OF 507-05 BD	

1 mm

2 mm

3 mm

4 mm





5 mm

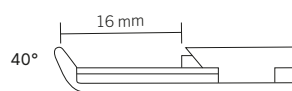

Kerrison  
long stroke



W/L:18 cm

		Detachable	Black
2 mm		<b>OF 522-02</b>	<b>OF 527-02</b>
3 mm		<b>OF 522-03</b>	<b>OF 527-03</b>
4 mm		<b>OF 522-04</b>	<b>OF 527-04</b>
5 mm		<b>OF 522-05</b>	<b>OF 527-05</b>
6 mm		<b>OF 522-06</b>	<b>OF 527-06</b>

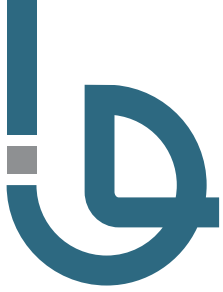

Caspar

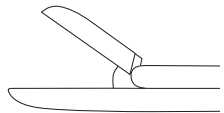





W/L:15,5 cm

W/L:14 cm

W/L:16 cm

W/L:18,5 cm

Detachable    Black                      Detachable    Black                      Detachable    Black                      Detachable    Black



2 mm		<b>RG 100-02</b>	<b>RG 100-02 BD</b>	<b>RG 300-14</b>	<b>RG 300-14 BD</b>	<b>RG 310-16</b>	<b>RG 310-16 BD</b>	<b>RG 315-18</b>	<b>RG 315-18 BD</b>
3 mm		<b>RG 100-03</b>	<b>RG 100-03 BD</b>	<b>RG 301-14</b>	<b>RG 301-14 BD</b>	<b>RG 311-16</b>	<b>RG 311-16 BD</b>	<b>RG 316-18</b>	<b>RG 316-18 BD</b>
4 mm		<b>RG 100-04</b>	<b>RG 100-04 BD</b>	<b>RG 302-14</b>	<b>RG 302-14 BD</b>	<b>RG 312-16</b>	<b>RG 312-16 BD</b>	<b>RG 317-18</b>	<b>RG 317-18 BD</b>
5 mm		<b>RG 100-05</b>	<b>RG 100-05 BD</b>			<b>RG 313-16</b>	<b>RG 313-16 BD</b>	<b>RG 318-18</b>	<b>RG 318-18 BD</b>
6 mm						<b>RG 314-16</b>	<b>RG 314-16 BD</b>	<b>RG 319-18</b>	<b>RG 319-18 BD</b>

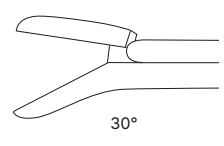

Caspar







	W/L:15,5 cm	W/L:14 cm	W/L:16 cm	W/L:18,5 cm
	Detachable	Detachable	Detachable	Detachable
	Black			

2 mm		<b>RG 102-02</b>	<b>RG 100-02 BD</b>			
3 mm		<b>RG 102-03</b>	<b>RG 100-03 BD</b>	<b>RG 350-14</b>	<b>RG 355-16</b>	<b>RG 360-18</b>
4 mm		<b>RG 102-04</b>	<b>RG 100-04 BD</b>	<b>RG 351-14</b>	<b>RG 356-16</b>	<b>RG 361-18</b>

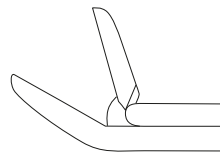

Caspar



	W/L:14 cm		W/L:16 cm		W/L:15,5 cm		W/L:18,5 cm		
	Detachable	Black	Detachable	Black	Detachable	Black	Detachable	Black	
2 mm					<b>RG 101-02</b>	<b>RG 101-02 BD</b>			
3 mm		<b>RG 330-14</b>	<b>RG 330-14 BD</b>	<b>RG 335-16</b>	<b>RG 335-16 BD</b>	<b>RG 101-03</b>	<b>RG 101-03 BD</b>	<b>RG 340-18</b>	<b>RG 340-18 BD</b>
4 mm		<b>RG 331-14</b>	<b>RG 331-14 BD</b>	<b>RG 336-16</b>	<b>RG 336-16 BD</b>	<b>RG 101-04</b>	<b>RG 101-04 BD</b>	<b>RG 341-18</b>	<b>RG 341-18 BD</b>
5 mm				<b>RG 337-16</b>	<b>RG 337-16 BD</b>			<b>RG 342-18</b>	<b>RG 342-18 BD</b>



W/L:18 cm

Cushing

2 mm  **RG 365-02** **RG 365-02 BD**

Love-Gruenwald

3 mm  **RG 365-03** **RG 365-03 BD**

Spurling

4 mm  **RG 365-04** **RG 365-04 BD**



W/L:18 cm

Love-Gruenwald

3 mm  **RG 366-03** **RG 366-03 BD**

Spurling

4 mm  **RG 365-03** **RG 365-03 BD**

Spurling

4 mm  **RG 365-04** **RG 365-04 BD**



**LF 110-01**  
Rail Clamp with ball joint



**LF 110-02**  
Holding Bar



**LF 110-03**  
Coupling head for 1-5 flexible arms



**LF 120-01**  
Flexible arm



**LF 120-02**  
Fixation Device for 1 Flexible Arm

**LF 120-03**  
Fixation Device for 2 Flexible Arms

**LF 120-04**  
Fixation Device for 1 Flexible Arm



**LF 100-00**

1 Arm Complete

**LF 101-00**

2 Arm Complete

**LF 110-00**

1 arm and OR table mounted complete



**LF 120-05**

Holder for Flat Spatulas



**LF 120-06**

Holder for Spatulas with round shaft

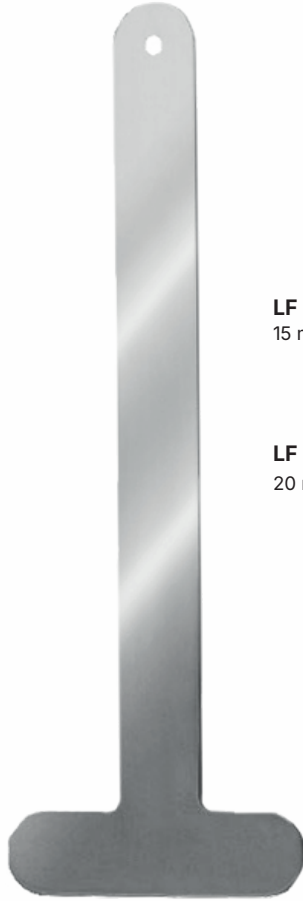

**LF 132-01**  
15 mm- 40 mm

**LF 132-02**  
20 mm- 50 mm

1/4

12 cm / 4 7/8"  
malleable



**LF 133-01**  
2 mm- 6 mm

**LF 133-02**  
5 mm- 10 mm

**LF 133-03**  
8 mm- 15 mm

**LF 133-04**  
12 mm- 17,5 mm

1/2

18 cm / 7 1/8"  
malleable



**LF 134-01**  
4 mm

**LF 134-02**  
8 mm

**LF 134-03**  
10 mm

**LF 134-04**  
14 mm

**LF 134-05**  
16 mm

**LF 134-06**  
19 mm

1/2

18 cm / 7 1/8"  
malleable

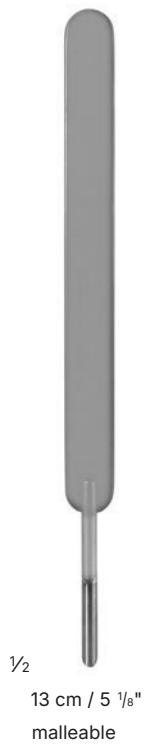

**LF 135-01**  
100x6 mm

**LF 135-02**  
100x10 mm

**LF 135-03**  
100x13 mm

**LF 135-04**  
100x18 mm



**LF 136-01**  
100x2/10 mm

**LF 136-02**  
100x3/10 mm

**LF 136-03**  
100x4/10 mm

**LF 136-04**  
100x5/10mm

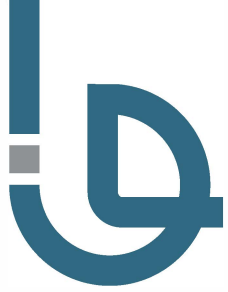

**OF 301-00**  
Skull Clamp Complete System

**OF 301-01**  
Skull Clamp

**OF 301-02**  
OR Table Fixation System

**OF 301-03**  
Fixation Pin



**Frazier**  
**HO 202-13**  
13 cm / 5 1/8"

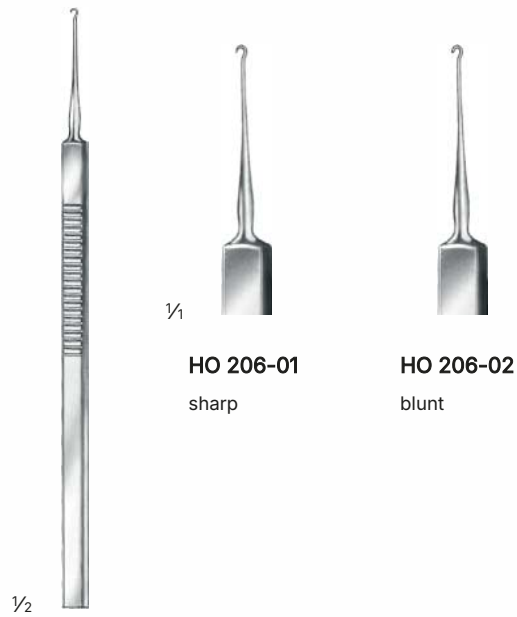

**Graefe**  
16 cm / 6 2/8"

**HO 206-01**  
sharp

**HO 206-02**  
blunt





+90 242 311 1 654

info@idolcerrahi.com

İdol Hastane Ürünleri San. Tic. A.Ş.

Altınova Sinan mah. 39/1 sk. No:75 Posta kodu:07170

ANTALYA / TÜRKİYE

All rights reserved CTLG.01-Thoracic, Cardiac and Vascular

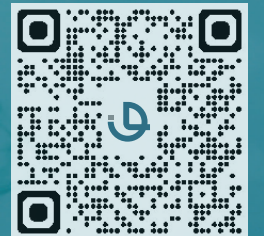

idolcerrahi.com

CE  
2696